

# Aerospace Toolbox

## User's Guide

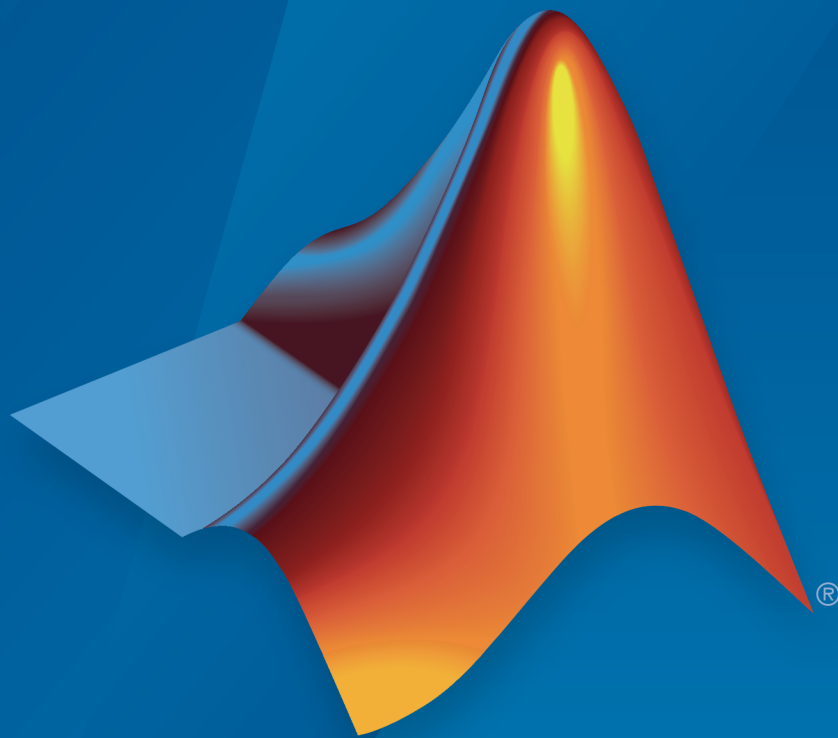

# MATLAB<sup>®</sup>

R2017a

 MathWorks<sup>®</sup>

## How to Contact MathWorks



Latest news: [www.mathworks.com](http://www.mathworks.com)  
Sales and services: [www.mathworks.com/sales\\_and\\_services](http://www.mathworks.com/sales_and_services)  
User community: [www.mathworks.com/matlabcentral](http://www.mathworks.com/matlabcentral)  
Technical support: [www.mathworks.com/support/contact\\_us](http://www.mathworks.com/support/contact_us)



Phone: 508-647-7000



The MathWorks, Inc.  
3 Apple Hill Drive  
Natick, MA 01760-2098

*Aerospace Toolbox User's Guide*

© COPYRIGHT 2006–2017 by The MathWorks, Inc.

The software described in this document is furnished under a license agreement. The software may be used or copied only under the terms of the license agreement. No part of this manual may be photocopied or reproduced in any form without prior written consent from The MathWorks, Inc.

**FEDERAL ACQUISITION:** This provision applies to all acquisitions of the Program and Documentation by, for, or through the federal government of the United States. By accepting delivery of the Program or Documentation, the government hereby agrees that this software or documentation qualifies as commercial computer software or commercial computer software documentation as such terms are used or defined in FAR 12.212, DFARS Part 227.72, and DFARS 252.227-7014. Accordingly, the terms and conditions of this Agreement and only those rights specified in this Agreement, shall pertain to and govern the use, modification, reproduction, release, performance, display, and disclosure of the Program and Documentation by the federal government (or other entity acquiring for or through the federal government) and shall supersede any conflicting contractual terms or conditions. If this License fails to meet the government's needs or is inconsistent in any respect with federal procurement law, the government agrees to return the Program and Documentation, unused, to The MathWorks, Inc.

### **Trademarks**

MATLAB and Simulink are registered trademarks of The MathWorks, Inc. See [www.mathworks.com/trademarks](http://www.mathworks.com/trademarks) for a list of additional trademarks. Other product or brand names may be trademarks or registered trademarks of their respective holders.

### **Patents**

MathWorks products are protected by one or more U.S. patents. Please see [www.mathworks.com/patents](http://www.mathworks.com/patents) for more information.

## Revision History

September 2006	Online only	New for Version 1.0 (Release 2006b)
March 2007	Online only	Revised for Version 1.1 (Release 2007a)
September 2007	First printing	Revised for Version 2.0 (Release 2007b)
March 2008	Online only	Revised for Version 2.1 (Release 2008a)
October 2008	Online only	Revised for Version 2.2 (Release 2008b)
March 2009	Online only	Revised for Version 2.3 (Release 2009a)
September 2009	Online only	Revised for Version 2.4 (Release 2009b)
March 2010	Online only	Revised for Version 2.5 (Release 2010a)
September 2010	Online only	Revised for Version 2.6 (Release 2010b)
April 2011	Online only	Revised for Version 2.7 (Release 2011a)
September 2011	Online only	Revised for Version 2.8 (Release 2011b)
March 2012	Online only	Revised for Version 2.9 (Release 2012a)
September 2012	Online only	Revised for Version 2.10 (Release 2012b)
March 2013	Online only	Revised for Version 2.11 (Release 2013a)
September 2013	Online only	Revised for Version 2.12 (Release 2013b)
March 2014	Online only	Revised for Version 2.13 (Release 2014a)
October 2014	Online only	Revised for Version 2.14 (Release 2014b)
March 2015	Online only	Revised for Version 2.15 (Release 2015a)
September 2015	Online only	Revised for Version 2.16 (Release 2015b)
March 2016	Online only	Revised for Version 2.17 (Release 2016a)
September 2016	Online only	Revised for Version 2.18 (Release 2016b)
March 2017	Online only	Revised for Version 2.19 (Release 2017a)



<b>1</b>	<b>Getting Started</b>	
	<b>Aerospace Toolbox Product Description</b> .....	1-2
	Key Features .....	1-2
	<b>Aerospace Toolbox and Aerospace Blockset</b> .....	1-3
<b>2</b>	<b>Using Aerospace Toolbox</b>	
	<b>Fundamental Coordinate System Concepts</b> .....	2-2
	Definitions .....	2-2
	Approximations .....	2-2
	Motion with Respect to Other Planets .....	2-3
	References .....	2-3
	<b>Coordinate Systems for Modeling</b> .....	2-4
	Body Coordinates .....	2-4
	Wind Coordinates .....	2-5
	<b>Coordinate Systems for Navigation</b> .....	2-7
	Geocentric and Geodetic Latitudes .....	2-7
	NED Coordinates .....	2-8
	ECI Coordinates .....	2-9
	ECEF Coordinates .....	2-10
	<b>Coordinate Systems for Display</b> .....	2-11
	<b>Aerospace Units</b> .....	2-12

<b>Digital DATCOM Data</b> .....	<b>2-14</b>
Digital DATCOM Data Overview .....	2-14
USAF Digital DATCOM File .....	2-14
Data from DATCOM Files .....	2-15
Imported DATCOM Data .....	2-15
Missing DATCOM Data .....	2-16
Aerodynamic Coefficients .....	2-19
<b>Aerospace Toolbox Animation Objects</b> .....	<b>2-23</b>
<b>Aero.Animation Objects</b> .....	<b>2-24</b>
Running the Example .....	2-24
<b>Simulated and Actual Flight Data Using Aero.Animation Objects</b> .....	<b>2-25</b>
Creating and Configuring an Animation Object .....	2-25
Loading Recorded Data for Flight Trajectories .....	2-25
Displaying Body Geometries in a Figure Window .....	2-26
Recording Animation Files .....	2-26
Playing Back Flight Trajectories Using the Animation Object .....	2-27
Viewing Recorded Animation Files .....	2-28
Manipulating the Camera .....	2-28
Moving and Repositioning Bodies .....	2-28
Creating a Transparency in the First Body .....	2-30
Changing the Color of the Second Body .....	2-32
Turning Off the Landing Gear of the Second Body .....	2-33
<b>Aero.VirtualRealityAnimation Objects</b> .....	<b>2-34</b>
Running the Example .....	2-34
<b>Example of Visualize Aircraft Takeoff and Chase Helicopter with the Virtual Reality Animation Object</b> .....	<b>2-35</b>
Visualize Aircraft Takeoff via Virtual Reality Animation Object .....	2-35
<b>Aero.FlightGearAnimation Objects</b> .....	<b>2-52</b>
About the FlightGear Interface .....	2-52
Configuring Your Computer for FlightGear .....	2-53
Install and Start FlightGear .....	2-56
Flight Simulator Interface Example .....	2-57
Running the Example .....	2-59

<b>Flight Trajectory Data</b> .....	<b>2-60</b>
Loading Recorded Flight Trajectory Data .....	<b>2-60</b>
Creating a Time Series Object from Trajectory Data .....	<b>2-60</b>
Creating a FlightGearAnimation Object .....	<b>2-60</b>
Modifying the FlightGearAnimation Object Properties .....	<b>2-62</b>
Generating the Run Script .....	<b>2-62</b>
Installing Additional FlightGear Scenery .....	<b>2-63</b>
Starting the FlightGear Flight Simulator .....	<b>2-63</b>
Playing Back the Flight Trajectory .....	<b>2-64</b>

### **Add-On for Ephemeris and Geoid Data Support**

**3**

Add Ephemeris and Geoid Data for Aerospace Products . . .	<b>3-2</b>
---	------------

### **Alphabetical List**

**4**

### **AC3D Files and Thumbnails**

**A**

AC3D Files and Thumbnails Overview .....	<b>A-2</b>
--	------------





# Getting Started

---

- “Aerospace Toolbox Product Description” on page 1-2
- “Aerospace Toolbox and Aerospace Blockset” on page 1-3

## Aerospace Toolbox Product Description

### **Aerospace reference standards, environmental models, and aerodynamic coefficient importing**

Aerospace Toolbox provides reference standards, environmental models, and aerodynamic coefficient importing for performing advanced aerospace analysis to develop and evaluate your designs. Options for visualizing vehicle dynamics include a six-degrees-of-freedom MATLAB® animation object and interfaces to FlightGear flight simulator and Simulink® 3D Animation™ software. These options let you visualize flight data in a three-dimensional (3-D) environment and reconstruct behavioral anomalies in flight-test results.

### **Key Features**

- Includes standards-based environmental models for atmosphere, gravity, geoid height, wind, and magnetic field
- Converts units and transforms coordinate systems and spatial representations
- Implements predefined utilities for aerospace parameter calculations, time calculations, and quaternion math
- Imports aerodynamic coefficients from the U.S. Air Force Digital Data Compendium (Datcom)
- Provides options for visualizing vehicle dynamics in a 3-D environment, including an interface to FlightGear flight simulator

## **Aerospace Toolbox and Aerospace Blockset**

The Aerospace product family includes the Aerospace Toolbox and Aerospace Blockset products. The toolbox provides static data analysis capabilities, while the blockset provides an environment for dynamic modeling and vehicle component modeling and simulation. The Aerospace Blockset software uses part of the functionality of the toolbox as an engine. Use these products together to model aerospace systems in the MATLAB and Simulink environments.



# Using Aerospace Toolbox

---

- “Fundamental Coordinate System Concepts” on page 2-2
- “Coordinate Systems for Modeling” on page 2-4
- “Coordinate Systems for Navigation” on page 2-7
- “Coordinate Systems for Display” on page 2-11
- “Aerospace Units” on page 2-12
- “Digital DATCOM Data” on page 2-14
- “Aerospace Toolbox Animation Objects” on page 2-23
- “Aero.Animation Objects” on page 2-24
- “Simulated and Actual Flight Data Using Aero.Animation Objects” on page 2-25
- “Aero.VirtualRealityAnimation Objects” on page 2-34
- “Example of Visualize Aircraft Takeoff and Chase Helicopter with the Virtual Reality Animation Object” on page 2-35
- “Aero.FlightGearAnimation Objects” on page 2-52
- “Flight Trajectory Data” on page 2-60

# Fundamental Coordinate System Concepts

Coordinate systems allow you to keep track of an aircraft or spacecraft's position and orientation in space. The Aerospace Toolbox coordinate systems are based on these underlying concepts from geodesy, astronomy, and physics.

## Definitions

The Aerospace Toolbox software uses *right-handed* (RH) Cartesian coordinate systems. The *right-hand rule* establishes the *x-y-z* sequence of coordinate axes.

An *inertial frame* is a nonaccelerating motion reference frame. Loosely speaking, acceleration is defined with respect to the distant cosmos. In an inertial frame, Newton's second law (force = mass X acceleration) holds.

Strictly defined, an inertial frame is a member of the set of all frames not accelerating relative to one another. A *noninertial frame* is any frame accelerating relative to an inertial frame. Its acceleration, in general, includes both translational and rotational components, resulting in *pseudoforces* (*pseudogravity*, as well as *Coriolis* and *centrifugal forces*).

The toolbox models the Earth's shape (the *geoid*) as an oblate spheroid, a special type of ellipsoid with two longer axes equal (defining the *equatorial plane*) and a third, slightly shorter (*geopolar*) axis of symmetry. The equator is the intersection of the equatorial plane and the Earth's surface. The geographic poles are the intersection of the Earth's surface and the geopolar axis. In general, the Earth's geopolar and rotation axes are not identical.

Latitudes parallel the equator. Longitudes parallel the geopolar axis. The *zero longitude* or *prime meridian* passes through Greenwich, England.

## Approximations

The Aerospace Toolbox software makes three standard approximations in defining coordinate systems relative to the Earth.

- The Earth's surface or geoid is an oblate spheroid, defined by its longer equatorial and shorter geopolar axes. In reality, the Earth is slightly deformed with respect to the standard geoid.

- The Earth's rotation axis and equatorial plane are perpendicular, so that the rotation and geopolar axes are identical. In reality, these axes are slightly misaligned, and the equatorial plane wobbles as the Earth rotates. This effect is negligible in most applications.
- The only noninertial effect in Earth-fixed coordinates is due to the Earth's rotation about its axis. This is a *rotating, geocentric* system. The toolbox ignores the Earth's motion around the Sun, the Sun's motion in the Galaxy, and the Galaxy's motion through cosmos. In most applications, only the Earth's rotation matters.

This approximation must be changed for spacecraft sent into deep space, i.e., outside the Earth-Moon system, and a heliocentric system is preferred.

## Motion with Respect to Other Planets

The Aerospace Toolbox software uses the standard WGS-84 geoid to model the Earth. You can change the equatorial axis length, the flattening, and the rotation rate.

You can represent the motion of spacecraft with respect to any celestial body that is well approximated by an oblate spheroid by changing the spheroid size, flattening, and rotation rate. If the celestial body is rotating westward (retrogradely), make the rotation rate negative.

## References

*Recommended Practice for Atmospheric and Space Flight Vehicle Coordinate Systems*, R-004-1992, ANSI/AIAA, February 1992.

Mapping Toolbox™ documentation, The MathWorks, Inc., Natick, Massachusetts. “Mapping Toolbox”.

Rogers, R. M., *Applied Mathematics in Integrated Navigation Systems*, AIAA, Reston, Virginia, 2000.

Stevens, B. L., and F. L. Lewis, *Aircraft Control and Simulation*, 2nd ed., Wiley-Interscience, New York, 2003.

Thomson, W. T., *Introduction to Space Dynamics*, John Wiley & Sons, New York, 1961/ Dover Publications, Mineola, New York, 1986.

World Geodetic System 1984 (WGS 84), <http://earth-info.nga.mil/GandG/wgs84>.

# Coordinate Systems for Modeling

Modeling aircraft and spacecraft is simplest if you use a coordinate system fixed in the body itself. In the case of aircraft, the forward direction is modified by the presence of wind, and the craft's motion through the air is not the same as its motion relative to the ground.

## Body Coordinates

The noninertial body coordinate system is fixed in both origin and orientation to the moving craft. The craft is assumed to be rigid.

The orientation of the body coordinate axes is fixed in the shape of body.

- The  $x$ -axis points through the nose of the craft.
- The  $y$ -axis points to the right of the  $x$ -axis (facing in the pilot's direction of view), perpendicular to the  $x$ -axis.
- The  $z$ -axis points down through the bottom of the craft, perpendicular to the  $x$ - $y$  plane and satisfying the RH rule.

## Translational Degrees of Freedom

Translations are defined by moving along these axes by distances  $x$ ,  $y$ , and  $z$  from the origin.

## Rotational Degrees of Freedom

Rotations are defined by the Euler angles  $P$ ,  $Q$ ,  $R$  or  $\Phi$ ,  $\Theta$ ,  $\Psi$ . They are

- $P$  or  $\Phi$ : Roll about the  $x$ -axis
- $Q$  or  $\Theta$ : Pitch about the  $y$ -axis
- $R$  or  $\Psi$ : Yaw about the  $z$ -axis



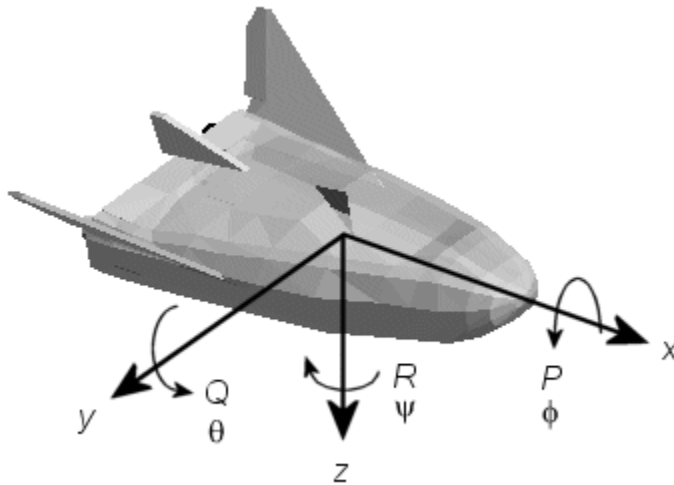

Unless otherwise specified, by default the software uses ZYX rotation order for Euler angles.

## Wind Coordinates

The noninertial wind coordinate system has its origin fixed in the rigid aircraft. The coordinate system orientation is defined relative to the craft's velocity  $V$ .

The orientation of the wind coordinate axes is fixed by the velocity  $V$ .

- The  $x$ -axis points in the direction of  $V$ .
- The  $y$ -axis points to the right of the  $x$ -axis (facing in the direction of  $V$ ), perpendicular to the  $x$ -axis.
- The  $z$ -axis points perpendicular to the  $x$ - $y$  plane in whatever way needed to satisfy the RH rule with respect to the  $x$ - and  $y$ -axes.

## Translational Degrees of Freedom

Translations are defined by moving along these axes by distances  $x$ ,  $y$ , and  $z$  from the origin.

### Rotational Degrees of Freedom

Rotations are defined by the Euler angles  $\Phi$ ,  $\gamma$ ,  $\chi$ . They are

- $\Phi$ : Bank angle about the  $x$ -axis
- $\gamma$ : Flight path about the  $y$ -axis
- $\chi$ : Heading angle about the  $z$ -axis

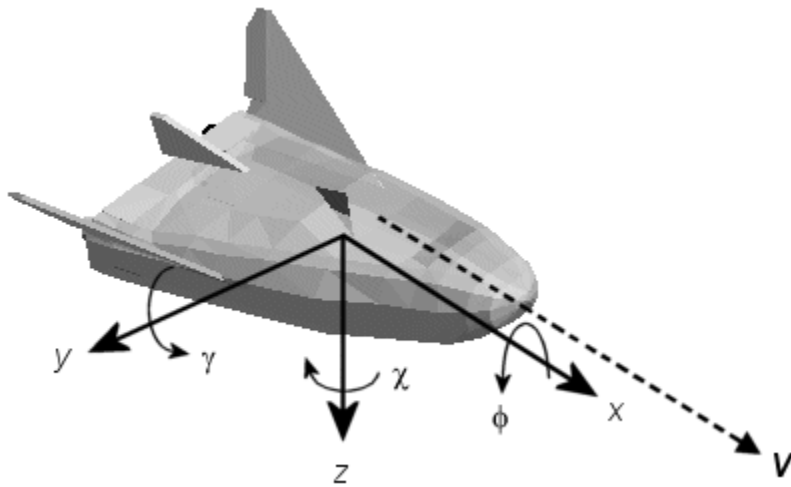

Unless otherwise specified, by default the software uses ZYX rotation order for Euler angles.

## Coordinate Systems for Navigation

Modeling aerospace trajectories requires positioning and orienting the aircraft or spacecraft with respect to the rotating Earth. Navigation coordinates are defined with respect to the center and surface of the Earth.

### Geocentric and Geodetic Latitudes

The *geocentric latitude*  $\lambda$  on the Earth's surface is defined by the angle subtended by the radius vector from the Earth's center to the surface point with the equatorial plane.

The *geodetic latitude*  $\mu$  on the Earth's surface is defined by the angle subtended by the surface normal vector  $n$  and the equatorial plane.

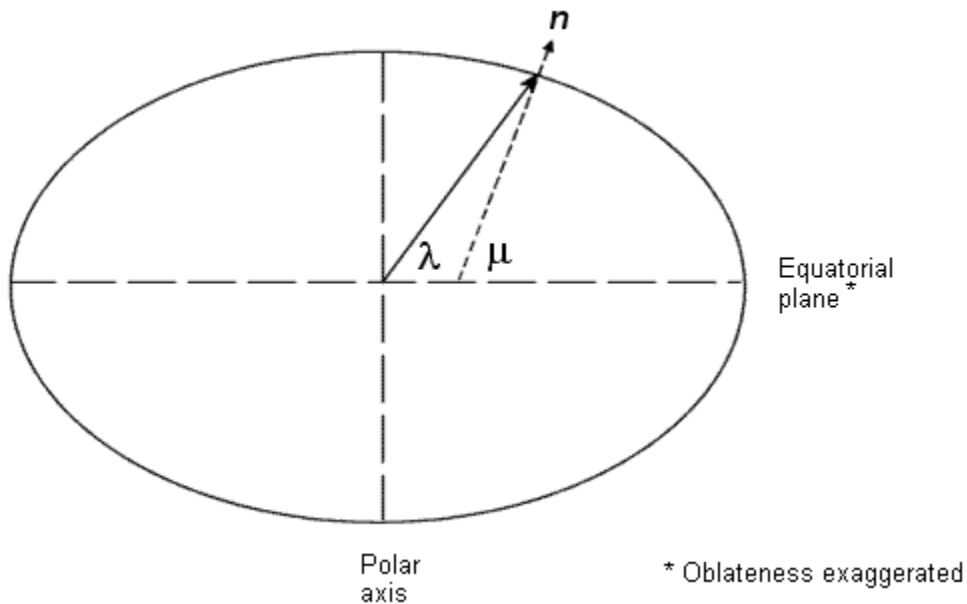

## NED Coordinates

The north-east-down (NED) system is a noninertial system with its origin fixed at the aircraft or spacecraft's center of gravity. Its axes are oriented along the geodetic directions defined by the Earth's surface.

- The  $x$ -axis points north parallel to the geoid surface, in the polar direction.
- The  $y$ -axis points east parallel to the geoid surface, along a latitude curve.
- The  $z$ -axis points downward, toward the Earth's surface, antiparallel to the surface's outward normal  $n$ .

Flying at a constant altitude means flying at a constant  $z$  above the Earth's surface.

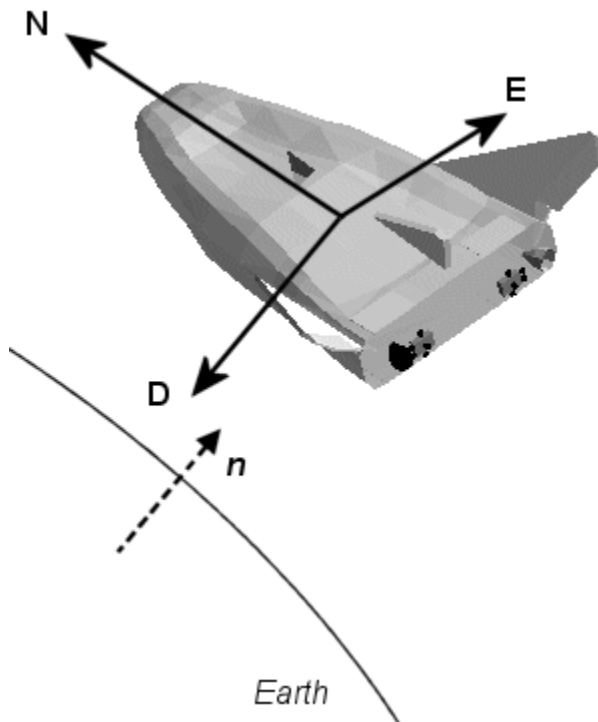

## ECI Coordinates

The Earth-centered inertial (ECI) system is a mixed inertial system. It is oriented with respect to the Sun. Its origin is fixed at the center of the Earth.

- The  $z$ -axis points northward along the Earth's rotation axis.
- The  $x$ -axis points outward in the Earth's equatorial plane exactly at the Sun. (This rule ignores the Sun's oblique angle to the equator, which varies with season. The actual Sun always remains in the  $x$ - $z$  plane.)
- The  $y$ -axis points into the eastward quadrant, perpendicular to the  $x$ - $z$  plane so as to satisfy the RH rule.

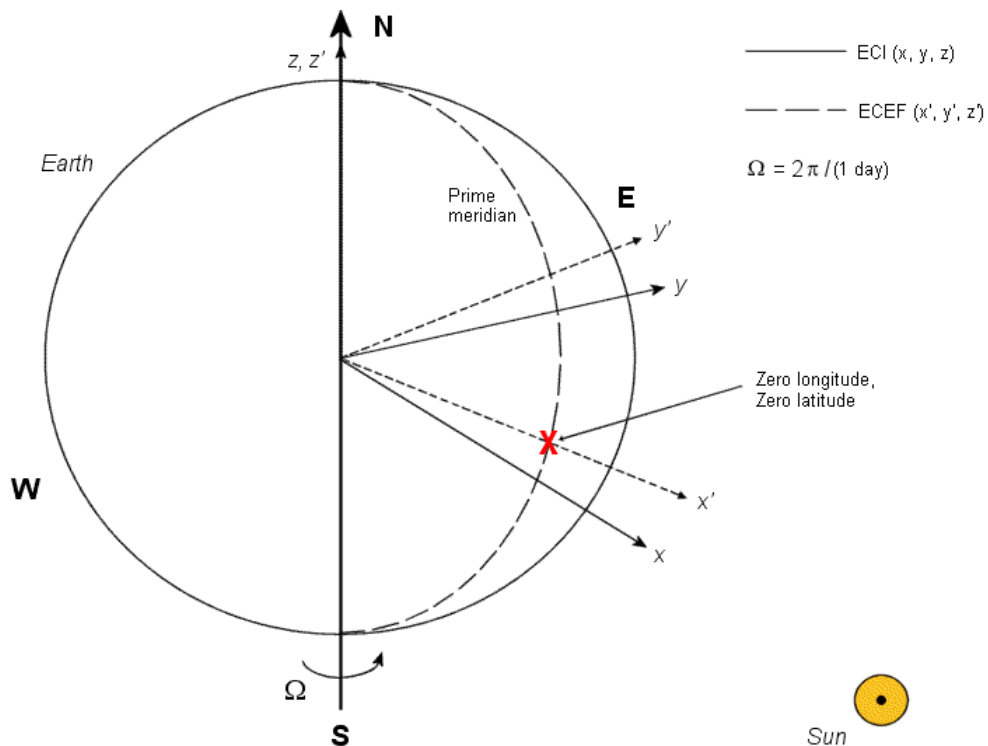

## Earth-Centered Coordinates

### ECEF Coordinates

The Earth-center, Earth-fixed (ECEF) system is a noninertial system that rotates with the Earth. Its origin is fixed at the center of the Earth.

- The  $z$ -axis points northward along the Earth's rotation axis.
- The  $x$ -axis points outward along the intersection of the Earth's equatorial plane and prime meridian.
- The  $y$ -axis points into the eastward quadrant, perpendicular to the  $x$ - $z$  plane so as to satisfy the RH rule.

## Coordinate Systems for Display

The Aerospace Toolbox software lets you use FlightGear coordinates for rendering motion.

FlightGear is an open-source, third-party flight simulator with an interface supported by the Aerospace Toolbox product.

- “Flight Simulator Interface Example” on page 2-57 discusses the toolbox interface to FlightGear.
- See the FlightGear documentation at [www.flightgear.org](http://www.flightgear.org) for complete information about this flight simulator.

The FlightGear coordinates form a special body-fixed system, rotated from the standard body coordinate system about the  $y$ -axis by  $-180$  degrees:

- The  $x$ -axis is positive toward the back of the vehicle.
- The  $y$ -axis is positive toward the right of the vehicle.
- The  $z$ -axis is positive upward, e.g., wheels typically have the lowest  $z$  values.

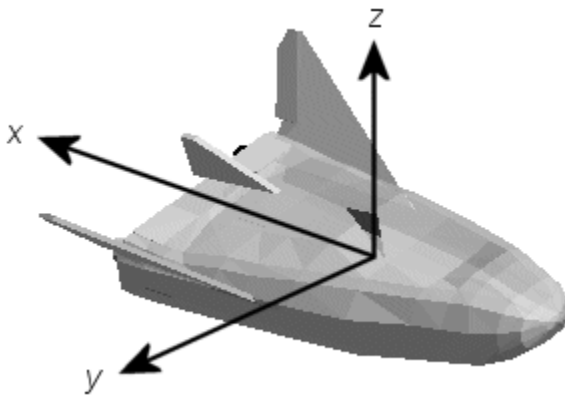

## Aerospace Units

The Aerospace Toolbox functions support standard measurement systems. The Unit Conversion functions provide means for converting common measurement units from one system to another, such as converting velocity from feet per second to meters per second and vice versa.

The unit conversion functions support all units listed in this table.

Quantity	MKS (SI)	English
Acceleration	meters/second <sup>2</sup> (m/s <sup>2</sup> ), kilometers/second <sup>2</sup> (km/s <sup>2</sup> ), (kilometers/hour)/second (km/h-s), g-unit ( <i>g</i> )	inches/second <sup>2</sup> (in/s <sup>2</sup> ), feet/second <sup>2</sup> (ft/s <sup>2</sup> ), (miles/hour)/second (mph/s), g-unit ( <i>g</i> )
Angle	radian (rad), degree (deg), revolution	radian (rad), degree (deg), revolution
Angular acceleration	radians/second <sup>2</sup> (rad/s <sup>2</sup> ), degrees/second <sup>2</sup> (deg/s <sup>2</sup> )	radians/second <sup>2</sup> (rad/s <sup>2</sup> ), degrees/second <sup>2</sup> (deg/s <sup>2</sup> )
Angular velocity	radians/second (rad/s), degrees/second (deg/s), revolutions/minute (rpm), revolutions/second (rps)	radians/second (rad/s), degrees/second (deg/s), revolutions/minute (rpm), revolutions/second (rps)
Density	kilogram/meter <sup>3</sup> (kg/m <sup>3</sup> )	pound mass/foot <sup>3</sup> (lbm/ft <sup>3</sup> ), slug/foot <sup>3</sup> (slug/ft <sup>3</sup> ), pound mass/inch <sup>3</sup> (lbm/in <sup>3</sup> )
Force	newton (N)	pound (lb)
Length	meter (m)	inch (in), foot (ft), mile (mi), nautical mile (nm)
Mass	kilogram (kg)	slug (slug), pound mass (lbm)
Pressure	pascal (Pa)	pound/inch <sup>2</sup> (psi), pound/foot <sup>2</sup> (psf), atmosphere (atm)
Temperature	kelvin (K), degrees Celsius (°C)	degrees Fahrenheit (°F), degrees Rankine (°R)



---

<b>Quantity</b>	<b>MKS (SI)</b>	<b>English</b>
Velocity	meters/second (m/s), kilometers/second (km/s), kilometers/hour (km/h)	inches/second (in/sec), feet/ second (ft/sec), feet/minute (ft/ min), miles/hour (mph), knots

## Digital DATCOM Data

### In this section...

“Digital DATCOM Data Overview” on page 2-14

“USAF Digital DATCOM File” on page 2-14

“Data from DATCOM Files” on page 2-15

“Imported DATCOM Data” on page 2-15

“Missing DATCOM Data” on page 2-16

“Aerodynamic Coefficients” on page 2-19

### Digital DATCOM Data Overview

The Aerospace Toolbox product enables bringing United States Air Force (USAF) Digital DATCOM files into the MATLAB environment by using the `datcomimport` function. For more information, see the `datcomimport` function reference page. This section explains how to import data from a USAF Digital DATCOM file.

The example used in the following topics is available as an Aerospace Toolbox example. You can run the example by entering `astimportddatcom` in the MATLAB Command Window.

### USAF Digital DATCOM File

The following is a sample input file for USAF Digital DATCOM for a wing-body-horizontal tail-vertical tail configuration running over five alphas, two Mach numbers, and two altitudes and calculating static and dynamic derivatives. You can also view this file by entering `typedatcom.in` in the MATLAB Command Window.

```
$FLTCON NMACH=2.0,MACH(1)=0.1,0.2$
$FLTCON NALT=2.0,ALT(1)=5000.0,8000.0$
$FLTCON NALPHA=5.,ALSCHD(1)=-2.0,0.0,2.0,
ALSCHD(4)=4.0,8.0,LOOP=2.0$
$OPTINS SREF=225.8,CBARR=5.75,BLREF=41.15$
$SYNTHS XCG=7.08,ZCG=0.0,XW=6.1,ZW=-1.4,ALIW=1.1,XH=20.2,
ZH=0.4,ALIH=0.0,XV=21.3,ZV=0.0,VERTUP=.TRUE.$
$BODY NX=10.0,
X(1)=-4.9,0.0,3.0,6.1,9.1,13.3,20.2,23.5,25.9,
R(1)=0.0,1.0,1.75,2.6,2.6,2.6,2.0,1.0,0.0$
$WGPNLF CHRDP=4.0,SSPNE=18.7,SSPN=20.6,CHDR=7.2,SAVSI=0.0,CHSTAT=0.25,
TWISTA=-1.1,SSPNDD=0.0,DHDADI=3.0,DHDADO=3.0,TYPE=1.0$
NACA-W-6-64A412
$HTPLNF CHRDP=2.3,SSPNE=5.7,SSPN=6.625,CHDR=0.25,SAVSI=11.0,
CHSTAT=1.0,TWISTA=0.0,TYPE=1.0$
NACA-H-4-0012
```

```

$VTPLNF CHRDP=2.7,SSPNE=5.0,SSPN=5.2,CHRRD=5.3,SAVSI=31.3,
  CHSTAT=0.25,TWISTA=0.0,TYPE=1.0$
NACA-V-4-0012
CASEID SKYHOGG BODY-WING-HORIZONTAL TAIL-VERTICAL TAIL CONFIG
DAMP
NEXT CASE

```

The output file generated by USAF Digital DATCOM for the same wing-body-horizontal tail-vertical tail configuration running over five alphas, two Mach numbers, and two altitudes can be viewed by entering type `astdatcom.out` in the MATLAB Command Window.

## Data from DATCOM Files

Use the `datcomimport` function to bring the Digital DATCOM data into the MATLAB environment.

```
alldata = datcomimport('astdatcom.out', true, 0);
```

## Imported DATCOM Data

The `datcomimport` function creates a cell array of structures containing the data from the Digital DATCOM output file.

```

data = alldata{1}
data =

    case: 'SKYHOGG BODY-WING-HORIZONTAL TAIL-VERTICAL TAIL CONFIG'
    mach: [0.1000 0.2000]
    alt: [5000 8000]
    alpha: [-2 0 2 4 8]
    nmach: 2
    nalt: 2
    nalpha: 5
    rnnub: []
    hypers: 0
    loop: 2
    sref: 225.8000
    cbar: 5.7500
    blref: 41.1500
    dim: 'ft'
    deriv: 'deg'
    stmach: 0.6000
    tsmach: 1.4000
    save: 0
    stype: []
    trim: 0
    damp: 1
    build: 1
    part: 0
    highsym: 0
    highasy: 0
    highcon: 0
    tjet: 0
    hypeff: 0

```

```

    lb: 0
    pwr: 0
    grnd: 0
    wsspn: 18.7000
    hsspn: 5.7000
    ndelta: 0
    delta: []
    deltal: []
    deltar: []
    ngh: 0
    grndht: []
    config: [1x1 struct]
        cd: [5x2x2 double]
        cl: [5x2x2 double]
        cm: [5x2x2 double]
        cn: [5x2x2 double]
        ca: [5x2x2 double]
        xcp: [5x2x2 double]
        cla: [5x2x2 double]
        cma: [5x2x2 double]
        cyb: [5x2x2 double]
        cnb: [5x2x2 double]
        clb: [5x2x2 double]
        qqinf: [5x2x2 double]
        eps: [5x2x2 double]
    deptsalp: [5x2x2 double]
        clq: [5x2x2 double]
        cmq: [5x2x2 double]
        clad: [5x2x2 double]
        cmad: [5x2x2 double]
        clp: [5x2x2 double]
        cyp: [5x2x2 double]
        cnp: [5x2x2 double]
        cnr: [5x2x2 double]
        clr: [5x2x2 double]

```

### Missing DATCOM Data

By default, missing data points are set to 99999 and data points are set to NaN where no DATCOM methods exist or where the method is not applicable.

It can be seen in the Digital DATCOM output file and examining the imported data that  $C_{Y\beta}$ ,  $C_{n\beta}$ ,  $C_{lq}$ , and  $C_{mq}$  have data only in the first alpha value. Here are the imported data values.

```

data.cyb
ans(:, :, 1) =

    1.0e+004 *

    -0.0000    -0.0000
     9.9999     9.9999
     9.9999     9.9999
     9.9999     9.9999
     9.9999     9.9999

```

```
ans(:,:,2) =  
1.0e+004 *  
-0.0000 -0.0000  
9.9999 9.9999  
9.9999 9.9999  
9.9999 9.9999  
9.9999 9.9999
```

```
data.cnb  
ans(:,:,1) =  
1.0e+004 *  
0.0000 0.0000  
9.9999 9.9999  
9.9999 9.9999  
9.9999 9.9999  
9.9999 9.9999
```

```
ans(:,:,2) =  
1.0e+004 *  
0.0000 0.0000  
9.9999 9.9999  
9.9999 9.9999  
9.9999 9.9999  
9.9999 9.9999
```

```
data.clq  
ans(:,:,1) =  
1.0e+004 *  
0.0000 0.0000  
9.9999 9.9999  
9.9999 9.9999  
9.9999 9.9999  
9.9999 9.9999
```

```
ans(:,:,2) =  
1.0e+004 *  
0.0000 0.0000  
9.9999 9.9999  
9.9999 9.9999  
9.9999 9.9999  
9.9999 9.9999
```

```
data.cmq  
ans(:,:,1) =  
1.0e+004 *  
-0.0000 -0.0000  
9.9999 9.9999  
9.9999 9.9999
```

```
9.9999 9.9999
9.9999 9.9999
```

```
ans(:,:,2) =
```

```
1.0e+004 *
-0.0000 -0.0000
9.9999 9.9999
9.9999 9.9999
9.9999 9.9999
9.9999 9.9999
```

The missing data points will be filled with the values for the first alpha, since these data points are meant to be used for all alpha values.

```
aerotab = {'cyb' 'cnb' 'clq' 'cmq'};
for k = 1:length(aerotab)
    for m = 1:data.nmach
        for h = 1:data.nalt
            data.(aerotab{k})(:,m,h) = data.(aerotab{k})(1,m,h);
        end
    end
end
```

Here are the updated imported data values.

```
data.cyb
ans(:,:,1) =
-0.0035 -0.0035
-0.0035 -0.0035
-0.0035 -0.0035
-0.0035 -0.0035
-0.0035 -0.0035
```

```
ans(:,:,2) =
```

```
-0.0035 -0.0035
-0.0035 -0.0035
-0.0035 -0.0035
-0.0035 -0.0035
-0.0035 -0.0035
```

```
data.cnb
ans(:,:,1) =
```

```
1.0e-003 *
0.9142 0.8781
0.9142 0.8781
0.9142 0.8781
0.9142 0.8781
0.9142 0.8781
```

```
ans(:,:,2) =
```

```

1.0e-003 *
    0.9190    0.8829
    0.9190    0.8829
    0.9190    0.8829
    0.9190    0.8829
    0.9190    0.8829

data.clq
ans(:,:,1) =
    0.0974    0.0984
    0.0974    0.0984
    0.0974    0.0984
    0.0974    0.0984
    0.0974    0.0984

ans(:,:,2) =
    0.0974    0.0984
    0.0974    0.0984
    0.0974    0.0984
    0.0974    0.0984
    0.0974    0.0984

data.cmq
ans(:,:,1) =
   -0.0892   -0.0899
   -0.0892   -0.0899
   -0.0892   -0.0899
   -0.0892   -0.0899
   -0.0892   -0.0899

ans(:,:,2) =
   -0.0892   -0.0899
   -0.0892   -0.0899
   -0.0892   -0.0899
   -0.0892   -0.0899
   -0.0892   -0.0899

```

## Aerodynamic Coefficients

You can now plot the aerodynamic coefficients:

- “Plotting Lift Curve Moments” on page 2-19
- “Plotting Drag Polar Moments” on page 2-20
- “Plotting Pitching Moments” on page 2-21

### Plotting Lift Curve Moments

```
h1 = figure;
```

```

figtitle = {'Lift Curve' ''};
for k=1:2
    subplot(2,1,k)
    plot(data.alpha,permute(data.cl(:,k,:),[1 3 2]))
    grid
    ylabel(['Lift Coefficient (Mach = ' num2str(data.mach(k)) ' ')'])
    title(figtitle{k});
end
xlabel('Angle of Attack (deg)')

```

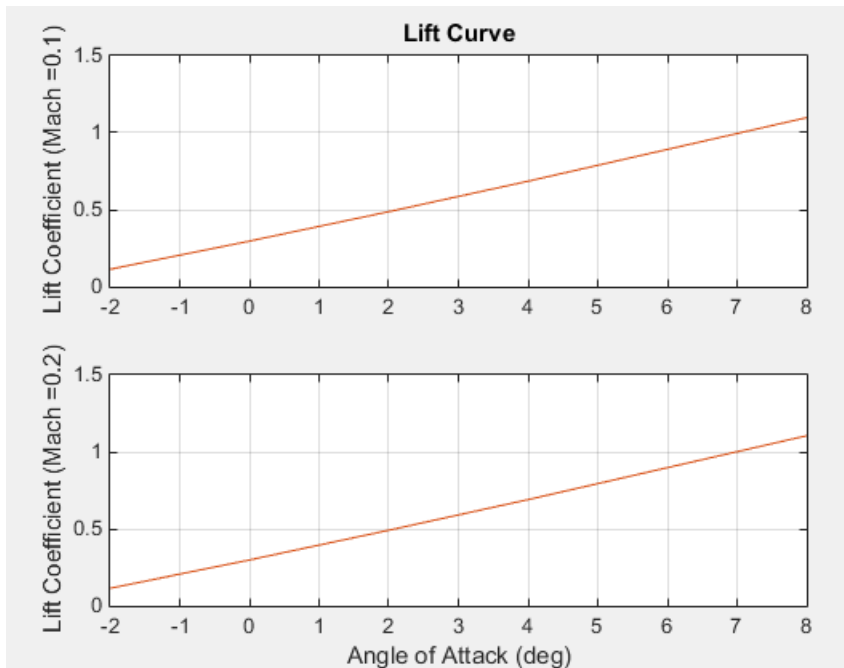

### Plotting Drag Polar Moments

```

h2 = figure;
figtitle = {'Drag Polar' ''};
for k=1:2
    subplot(2,1,k)
    plot(permute(data.cd(:,k,:),[1 3 2]),permute(data.cl(:,k,:),[1 3 2]))
    grid
    ylabel(['Lift Coefficient (Mach = ' num2str(data.mach(k)) ' ')'])
    title(figtitle{k})
end
xlabel('Drag Coefficient')

```



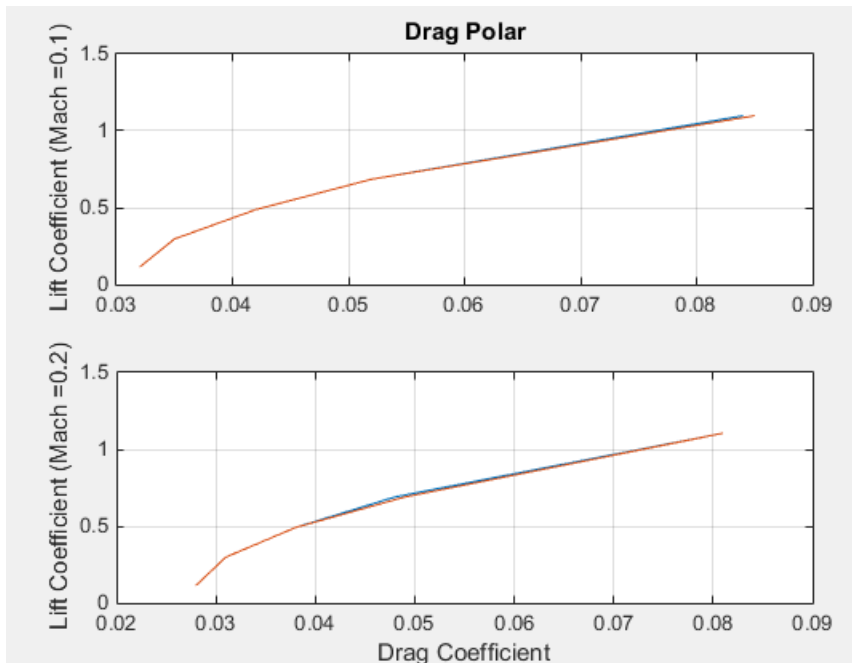

### Plotting Pitching Moments

```

h3 = figure;
figtitle = {'Pitching Moment' ''};
for k=1:2
    subplot(2,1,k)
    plot(permute(data.cm(:,k,:),[1 3 2]),permute(data.cl(:,k,:),[1 3 2]))
    grid
    ylabel(['Lift Coefficient (Mach =' num2str(data.mach(k)) ' ')'])
    title(figtitle{k})
end
xlabel('Pitching Moment Coefficient')

```

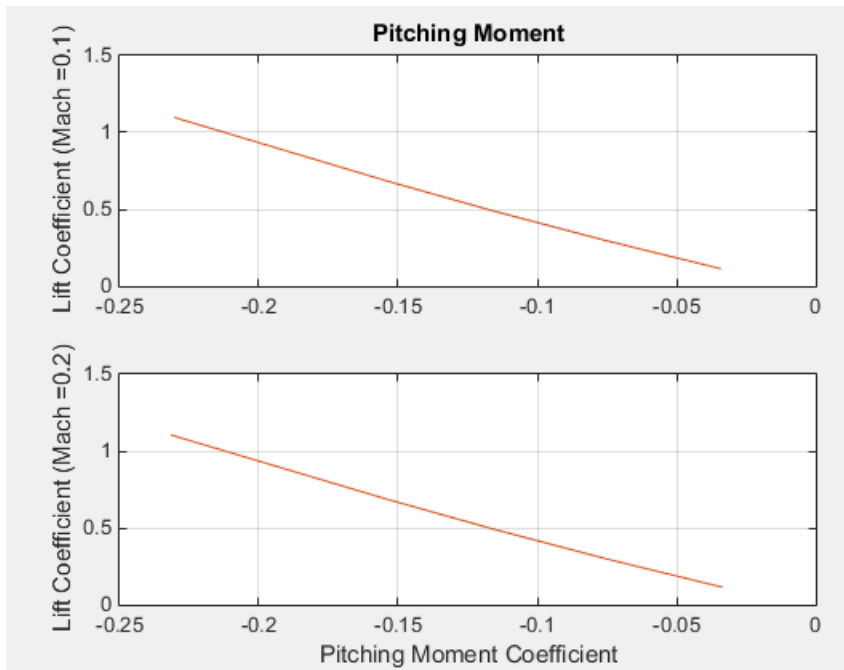

## Aerospace Toolbox Animation Objects

To visualize flight data in the Aerospace Toolbox environment, you can use the following animation objects and their associated methods. These animation objects use the MATLAB time series object, `timeseries` to visualize flight data.

- `Aero.Animation` — Visualize flight data without any other tool or toolbox. The following objects support this object.
  - `Aero.Body`
  - `Aero.Camera`
  - `Aero.Geometry`

For more information, see “`Aero.Animation` Objects” on page 2-24.

- `Aero.VirtualRealityAnimation` — Visualize flight data with the Simulink 3D Animation product. The following objects support this object.
  - `Aero.Node`
  - `Aero.Viewpoint`

For more information, see “`Aero.VirtualRealityAnimation` Objects” on page 2-34.

- `Aero.FlightGearAnimation` — Visualize flight data with the FlightGear simulator. For more information, see “`Aero.FlightGearAnimation` Objects” on page 2-52.

## Aero.Animation Objects

The toolbox interface to animation objects uses the Handle Graphics capability. The Overlaying Simulated and Actual Flight Data (astmlanim) example visually compares simulated and actual flight trajectory data by creating animation objects, creating bodies for those objects, and loading the flight trajectory data.

- Create and configure an animation object.
- Load recorded data for flight trajectories.
- Display body geometries in a figure window.
- Play back flight trajectories using the animation object.
- Manipulate the camera.
- Move and reposition bodies.
- Create a transparency in the first body.
- Change the color of the second body.
- Turn off the landing gear of the second body.

### Running the Example

- 1 Start the MATLAB software.
- 2 Enter astmlanim in the MATLAB Command Window.

While running, the example performs several steps by issuing a series of commands.

# Simulated and Actual Flight Data Using Aero.Animation Objects

## Creating and Configuring an Animation Object

This series of commands creates an animation object and configures the object.

- 1 Create an animation object.

```
h = Aero.Animation;
```

- 2 Configure the animation object to set the number of frames per second (`FramesPerSecond`) property. This configuration controls the rate at which frames are displayed in the figure window.

```
h.FramesPerSecond = 10;
```

- 3 Configure the animation object to set the seconds of animation data per second time scaling (`TimeScaling`) property.

```
h.TimeScaling = 5;
```

The combination of `FramesPerSecond` and `TimeScaling` property determine the time step of the simulation. These settings result in a time step of approximately 0.5 s.

- 4 Create and load bodies for the animation object. This example uses these bodies to work with and display the simulated and actual flight trajectories. The first body is orange; it represents simulated data. The second body is blue; it represents the actual flight data.

```
idx1 = h.createBody('pa24-250_orange.ac', 'Ac3d');  
idx2 = h.createBody('pa24-250_blue.ac', 'Ac3d');
```

Both bodies are AC3D format files. AC3D is one of several file formats that the animation objects support. FlightGear uses the same file format. The animation object reads in the bodies in the AC3D format and stores them as patches in the geometry object within the animation object.

## Loading Recorded Data for Flight Trajectories

This series of commands loads the recorded flight trajectory data, which is contained in files in the `matlabroot\toolbox\ aero\astdemos` folder.

- `simdata` – Contains simulated flight trajectory data, which is set up as a 6DoF array.
- `fltdata` – Contains actual flight trajectory data which is set up in a custom format. To access this custom format data, the example must set the body object **TimeSeriesSourceType** parameter to `Custom` and then specify a custom read function.

1 Load the flight trajectory data.

```
load simdata
load fltdata
```

2 Set the time series data for the two bodies.

```
h.Bodies{1}.TimeSeriesSource = simdata;
h.Bodies{2}.TimeSeriesSource = fltdata;
```

3 Identify the time series for the second body as custom.

```
h.Bodies{2}.TimeSeriesSourceType = 'Custom';
```

4 Specify the custom read function to access the data in `fltdata` for the second body. The example provides the custom read function in `matlabroot\toolbox\astro\astdemos\CustomReadBodyTSDData.m`.

```
h.Bodies{2}.TimeseriesReadFcn = @CustomReadBodyTSDData;
```

## Displaying Body Geometries in a Figure Window

This command creates a figure object for the animation object.

```
h.show();
```

## Recording Animation Files

Enable recording of the playback of flight trajectories using the animation object.

```
h.VideoRecord = 'on';
h.VideoQuality = 50;
h.VideoCompression = 'Motion JPEG AVI'
h.VideoFilename = 'astMotion_JPEG';
```

Enable animation recording at any point that you want to preserve an animation sequence.

---

**Note:** When choosing the video compression type, keep in mind that you will need the corresponding viewer software. For example, if you create an AVI format, you need a viewer such as Windows Media® Player to view the file.

---

After you play the animation as described in “Playing Back Flight Trajectories Using the Animation Object” on page 2-27, `astMotion_JPEG` contains a recording of the playback.

## Playing Back Flight Trajectories Using the Animation Object

This command plays back the animation bodies for the duration of the time series data. This playback shows the differences between the simulated and actual flight data.

```
h.play();
```

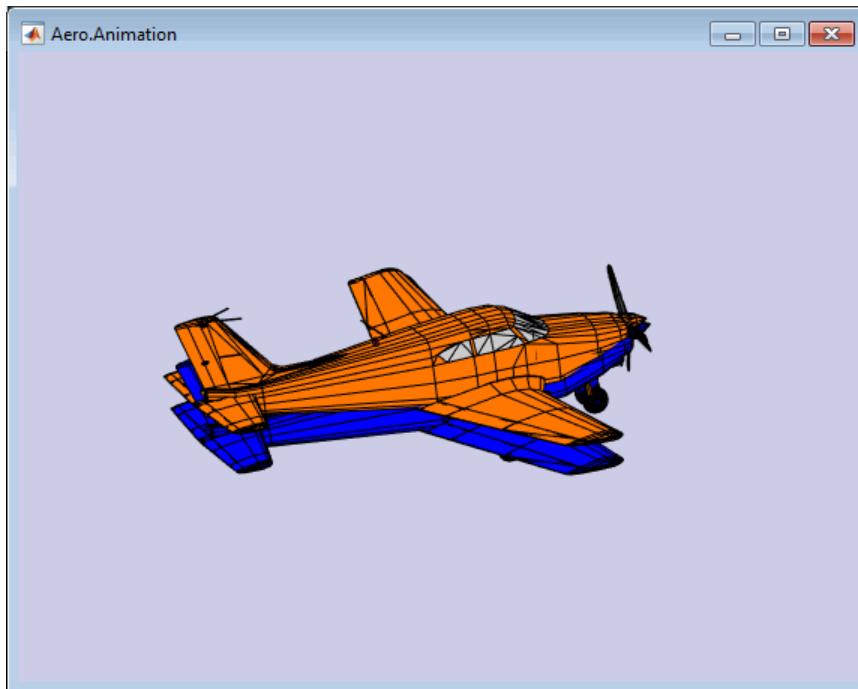

If you used the `Video` properties to store the recording, see “Viewing Recorded Animation Files” on page 2-28 for a description of how to view the files.

### Viewing Recorded Animation Files

If you do not have an animation file to view, see “Recording Animation Files” on page 2-26.

- 1 Open the folder that contains the animation file you want to view.
- 2 View the animation file with an application of your choice.

If your animation file is not yet running, start it now from the application.

- 3 To prevent other `h.play` commands from overwriting the contents of the animation file, disable the recording after you are satisfied with the contents.

```
h.VideoRecord = 'off';
```

### Manipulating the Camera

This command series shows how you can manipulate the camera on the two bodies and redisplay the animation. The `PositionFcn` property of a camera object controls the camera position relative to the bodies in the animation. In “Playing Back Flight Trajectories Using the Animation Object” on page 2-27, the camera object uses a default value for the `PositionFcn` property. In this command series, the example references a custom `PositionFcn` function that uses a static position based on the position of the bodies. No dynamics are involved.

---

**Note:** The custom `PositionFcn` function is located in the `matlabroot\toolbox\ aero \astdemos` folder.

---

- 1 Set the camera `PositionFcn` to the custom function `staticCameraPosition`.

```
h.Camera.PositionFcn = @staticCameraPosition;
```

- 2 Run the animation again.

```
h.play();
```

### Moving and Repositioning Bodies

This series of commands illustrates how to move and reposition bodies.



- 1 Set the starting time to 0.

```
t = 0;
```

- 2 Move the body to the starting position that is based on the time series data. Use the Aero.Animation object `Aero.Animation.updateBodies` method.

```
h.updateBodies(t);
```

- 3 Update the camera position using the custom `PositionFcn` function set in the previous section. Use the Aero.Animation object `Aero.Animation.updateCamera` method.

```
h.updateCamera(t);
```

- 4 Reposition the bodies by first getting the current body position, then separating the bodies.

- a Get the current body positions and rotations from the objects of both bodies.

```
pos1 = h.Bodies{1}.Position;
rot1 = h.Bodies{1}.Rotation;
pos2 = h.Bodies{2}.Position;
rot2 = h.Bodies{2}.Rotation;
```

- b Separate and reposition the bodies by moving them to new positions.

```
h.moveBody(1,pos1 + [0 0 -3],rot1);
h.moveBody(2,pos1 + [0 0 0],rot2);
```

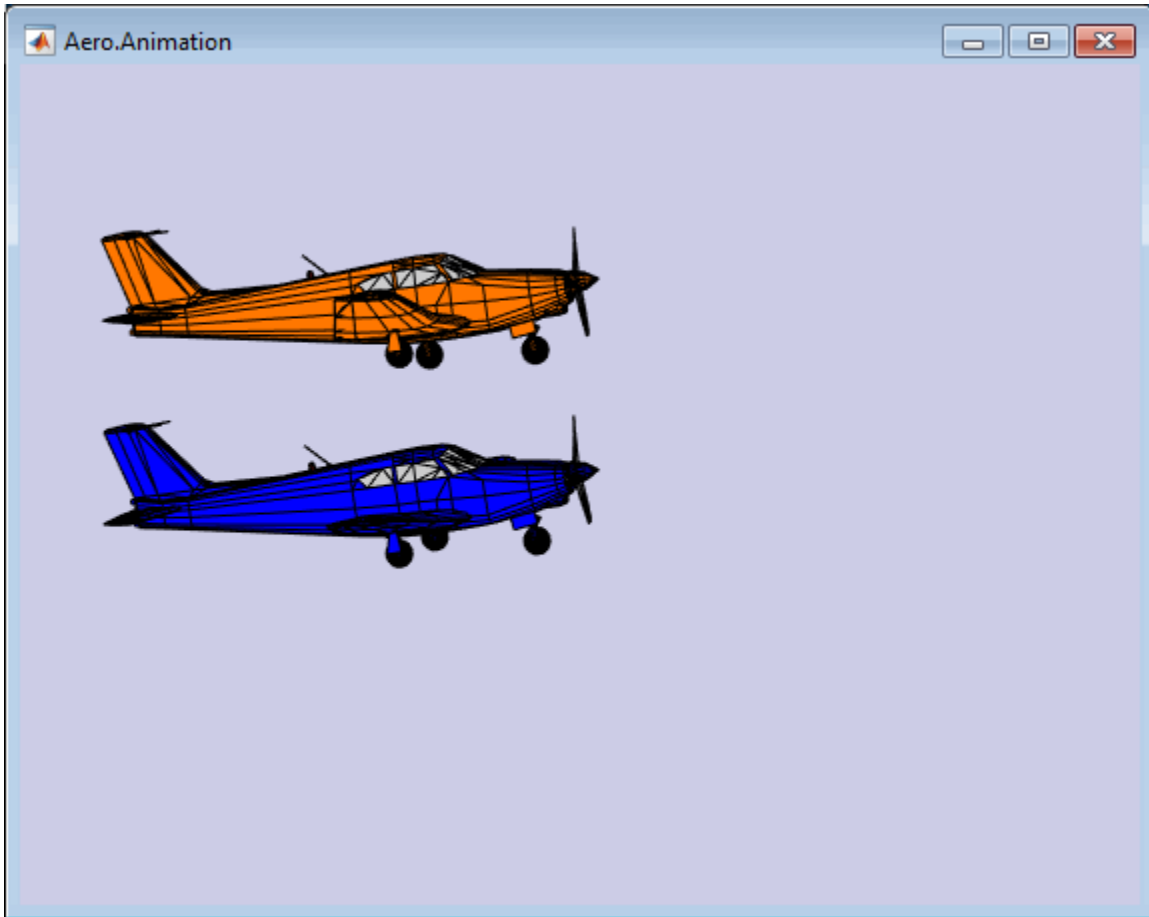

## Creating a Transparency in the First Body

This series of commands illustrates how to create and attach a transparency to a body. The animation object stores the body geometry as patches. This example manipulates the transparency properties of these patches (see Patch Properties).

---

**Note:** The use of transparencies might decrease animation speed on platforms that use software OpenGL<sup>®</sup> rendering (see `opengl`).

---

- 1 Change the body patch properties. Use the Aero.Body PatchHandles property to get the patch handles for the first body.

```
patchHandles2 = h.Bodies{1}.PatchHandles;
```

- 2 Set the face and edge alpha values that you want for the transparency.

```
desiredFaceTransparency = .3;  
desiredEdgeTransparency = 1;
```

- 3 Get the current face and edge alpha data and change all values to the alpha values that you want. In the figure, the first body now has a transparency.

```
for k = 1:size(patchHandles2,1)  
    tempFaceAlpha = get(patchHandles2(k), 'FaceVertexAlphaData');  
    tempEdgeAlpha = get(patchHandles2(k), 'EdgeAlpha');  
    set(patchHandles2(k), ...  
        'FaceVertexAlphaData', repmat(desiredFaceTransparency, size(tempFaceAlpha)));  
    set(patchHandles2(k), ...  
        'EdgeAlpha', repmat(desiredEdgeTransparency, size(tempEdgeAlpha)));  
end
```

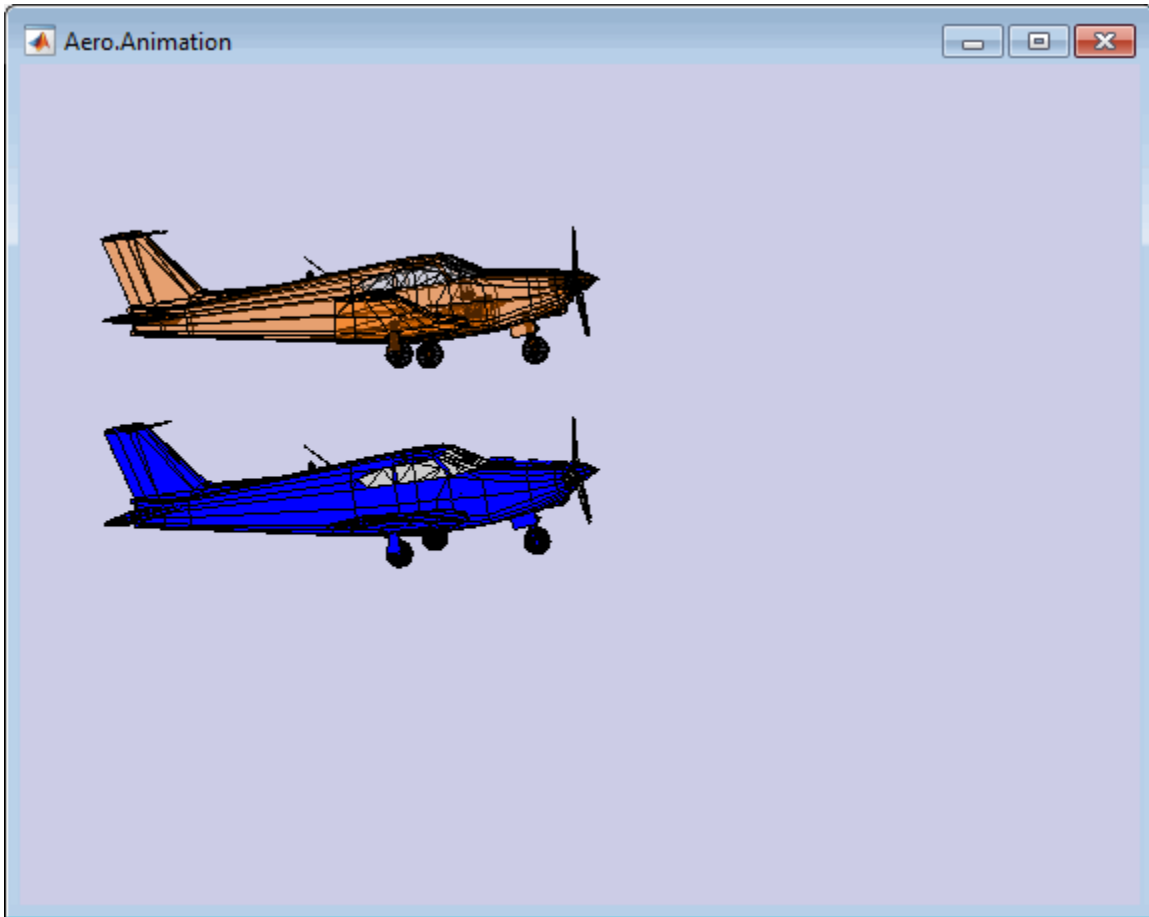

## Changing the Color of the Second Body

This series of commands illustrates how to change the color of a body. The animation object stores the body geometry as patches. This example manipulates the `FaceVertexColorData` property of these patches.

- 1 Change the body patch properties. Use the `Aero.Body PatchHandles` property to get the patch handles for the first body.

```
patchHandles3 = h.Bodies{2}.PatchHandles;
```

- 2 Set the patch color to red.

```
desiredColor = [1 0 0];
```

- 3 Get the current face color and data and propagate the new patch color, red, to the face.
  - The `if` condition prevents the windows from being colored.
  - The `name` property is stored in the body geometry data (`h.Bodies{2}.Geometry.FaceVertexColorData(k).name`).
  - The code changes only the indices in `patchHandles3` with nonwindow counterparts in the body geometry data.

---

**Note:** If you cannot access the `name` property to determine the parts of the vehicle to color, you must use an alternative way to selectively color your vehicle.

---

```
for k = 1:size(patchHandles3,1)
    tempFaceColor = get(patchHandles3(k), 'FaceVertexCData');
    tempName = h.Bodies{2}.Geometry.FaceVertexColorData(k).name;
    if isempty(strfind(tempName, 'Windshield')) &&...
        isempty(strfind(tempName, 'front-windows')) &&...
        isempty(strfind(tempName, 'rear-windows'))
        set(patchHandles3(k),...
            'FaceVertexCData', repmat(desiredColor, [size(tempFaceColor,1),1]));
    end
end
```

## Turning Off the Landing Gear of the Second Body

This command series illustrates how to turn off the landing gear on the second body by turning off the visibility of all the vehicle parts associated with the landing gear.

---

**Note:** The indices into the `patchHandles3` vector are determined from the `name` property. If you cannot access the `name` property to determine the indices, you must use an alternative way to determine the indices that correspond to the geometry parts.

---

```
for k = [1:8,11:14,52:57]
    set(patchHandles3(k), 'Visible', 'off')
end
```

## Aero.VirtualRealityAnimation Objects

The Aerospace Toolbox interface to virtual reality animation objects uses the Simulink 3D Animation software. For more information, see `Aero.VirtualRealityAnimation`, `Aero.Node`, and `Aero.Viewpoint`.

- Create, configure, and initialize an animation object.
- Enable the tracking of changes to virtual worlds.
- Load the animation world.
- Load time series data for simulation.
- Set coordination information for the object.
- Add a chase helicopter to the object.
- Load time series data for chase helicopter simulation.
- Set coordination information for the new object.
- Add a new viewpoint for the helicopter.
- Play the animation.
- Create a new viewpoint.
- Add a route.
- Add another helicopter.
- Remove bodies.
- Revert to the original world.

### Running the Example

- 1 Start the MATLAB software.
- 2 Enter `astvranim` in the MATLAB Command Window.

While running, the example performs several steps by issuing a series of commands.

# Example of Visualize Aircraft Takeoff and Chase Helicopter with the Virtual Reality Animation Object

## Visualize Aircraft Takeoff via Virtual Reality Animation Object

This example shows how to visualize aircraft takeoff and chase helicopter with the virtual reality animation object. In this example, you can use the `Aero.VirtualRealityAnimation` object to set up a virtual reality animation based on the `asttkoff.wrl` file. The scene simulates an aircraft takeoff. The example adds a chase vehicle to the simulation and a chase viewpoint associated with the new vehicle.

### Create the Animation Object

This code creates an instance of the `Aero.VirtualRealityAnimation` object.

```
h = Aero.VirtualRealityAnimation;
```

### Set the Animation Object Properties

This code sets the number of frames per second and the seconds of animation data per second time scaling. 'FramesPerSecond' controls the rate at which frames are displayed in the figure window. 'TimeScaling' is the seconds of animation data per second time scaling.

The 'TimeScaling' and 'FramesPerSecond' properties determine the time step of the simulation. The settings in this example result in a time step of approximately 0.5s. The equation is:

$(1/\text{FramesPerSecond}) * \text{TimeScaling} + \text{extra terms to handle for sub-second precision.}$

```
h.FramesPerSecond = 10;  
h.TimeScaling = 5;
```

This code sets the `.wrl` file to be used in the virtual reality animation.

```
h.VRWorldFilename = [matlabroot, '/toolbox/aero/astdemos/asttkoff.wrl'];
```

### Change Directory

The `VirtualRealityAnimation` object methods use temporary `.wrl` files to keep track of changes to the world. This requires the directory containing the original `.wrl` file to be

writable. This code runs the example from a temporary directory to ensure there are no issues with directory permissions. Note, a license for Simulink® 3D Animation™ is required to run this example.

```
% Copy file to temporary directory
copyfile(h.VRWorldFilename,[tempdir,'asttkoff.wrl'],'f');
% Set world filename to the copied .wrl file.
h.VRWorldFilename = [tempdir,'asttkoff.wrl'];
```

### **Initialize the Virtual Reality Animation Object**

The `initialize` method loads the animation world described in the `'VRWorldFilename'` field of the animation object. When parsing the world, node objects are created for existing nodes with DEF names. The `initialize` method also opens the Simulink 3D Animation viewer.

```
h.initialize();
```



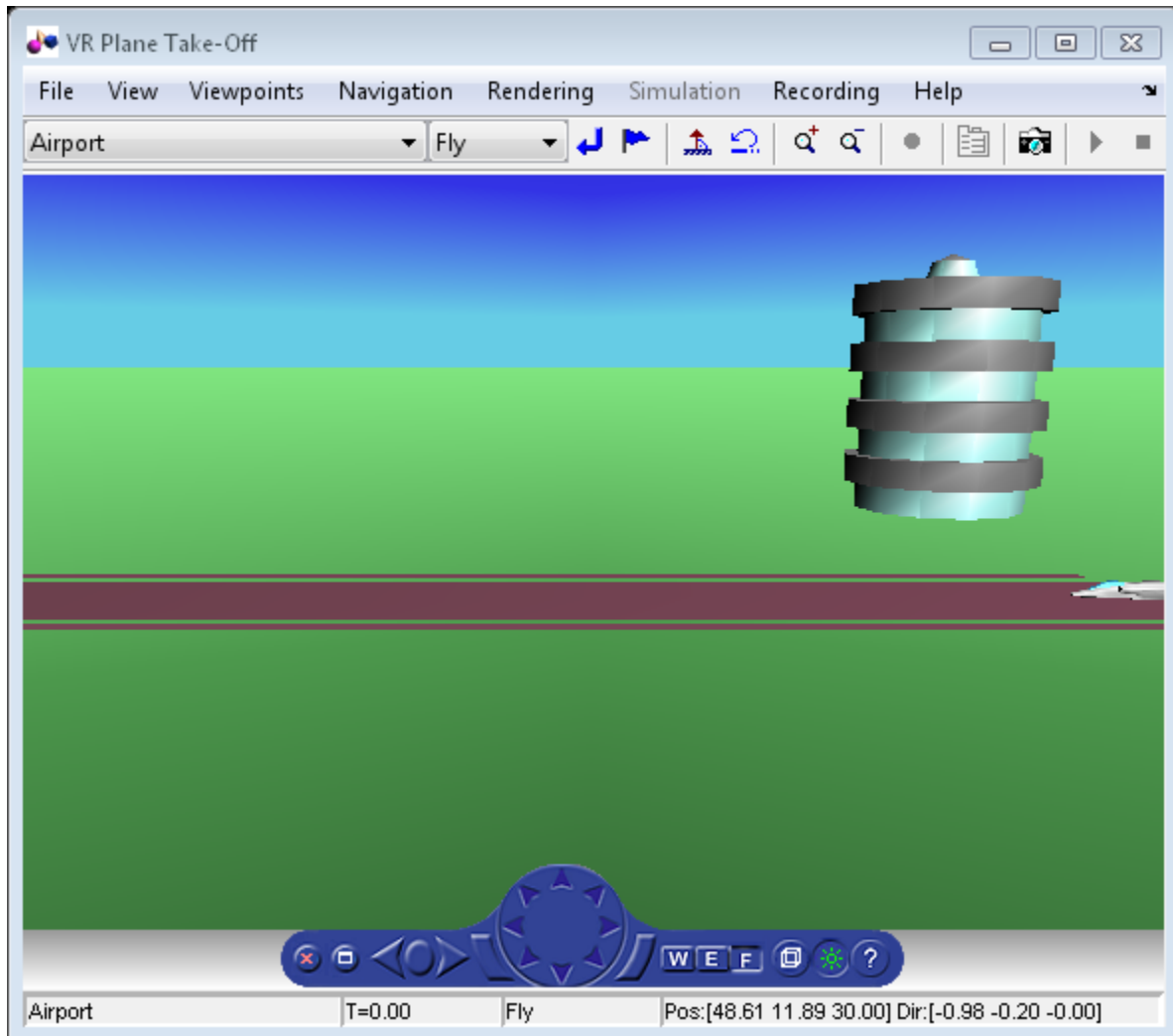

### Set Additional Node Information

This code sets simulation timeseries data. `takeoffData.mat` contains logged simulated data. `takeoffData` is set up as a 'StructureWithTime', which is one of the default data formats.

```
load takeoffData
```

```
[~, idxPlane] = find(strcmp('Plane', h.nodeInfo));  
h.Nodes{idxPlane}.TimeseriesSource = takeoffData;  
h.Nodes{idxPlane}.TimeseriesSourceType = 'StructureWithTime';
```

### Set Coordinate Transform Function

The virtual reality animation object expects positions and rotations in aerospace body coordinates. If the input data is different, you must create a coordinate transformation function in order to correctly line up the position and rotation data with the surrounding objects in the virtual world. This code sets the coordinate transformation function for the virtual reality animation.

In this particular case, if the input translation coordinates are  $[x1,y1,z1]$ , they must be adjusted as follows:  $[X,Y,Z] = -[y1,x1,z1]$ . The custom transform function can be seen here: `matlabroot/toolbox/aero/astdemos/vranimCustomTransform.m`

```
h.Nodes{idxPlane}.CoordTransformFcn = @vranimCustomTransform;
```

### Add a Chase Helicopter

This code shows how to add a chase helicopter to the animation object.

You can view all the nodes currently in the virtual reality animation object by using the `nodeInfo` method. When called with no output argument, this method prints the node information to the command window. With an output argument, the method sets node information to that argument.

```
h.nodeInfo;
```

```
Node Information  
1 Camera1  
2 Plane  
3 _V2  
4 Block  
5 Terminal  
6 _v3  
7 Lighthouse  
8 _v1
```

This code moves the camera angle of the virtual reality figure to view the aircraft.

```
set(h.VRFigure, 'CameraDirection', [0.45 0 -1]);
```

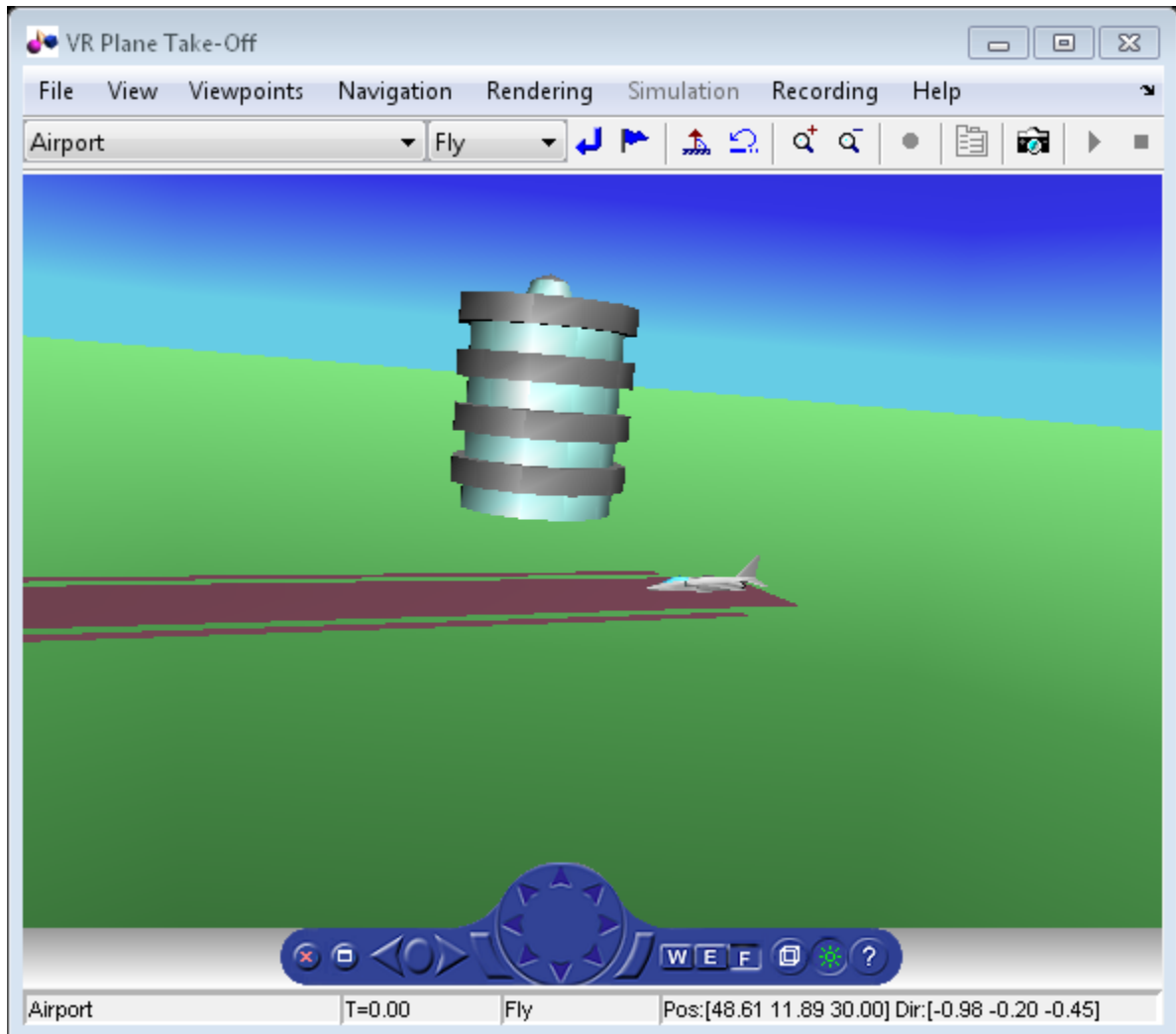

Use the `addNode` method to add another node to the object. By default, each time you add or remove a node or route, or when you call the `saveas` method, Aerospace Toolbox displays a message about the current `.wrl` file location. To disable this message, set the `'ShowSaveWarning'` property in the `VirtualRealityAnimation` object.

```
h.ShowSaveWarning = false;
h.addNode('Lynx',[matlabroot,'/toolbox/aero/astdemos/chaseHelicopter.wrl']);
```

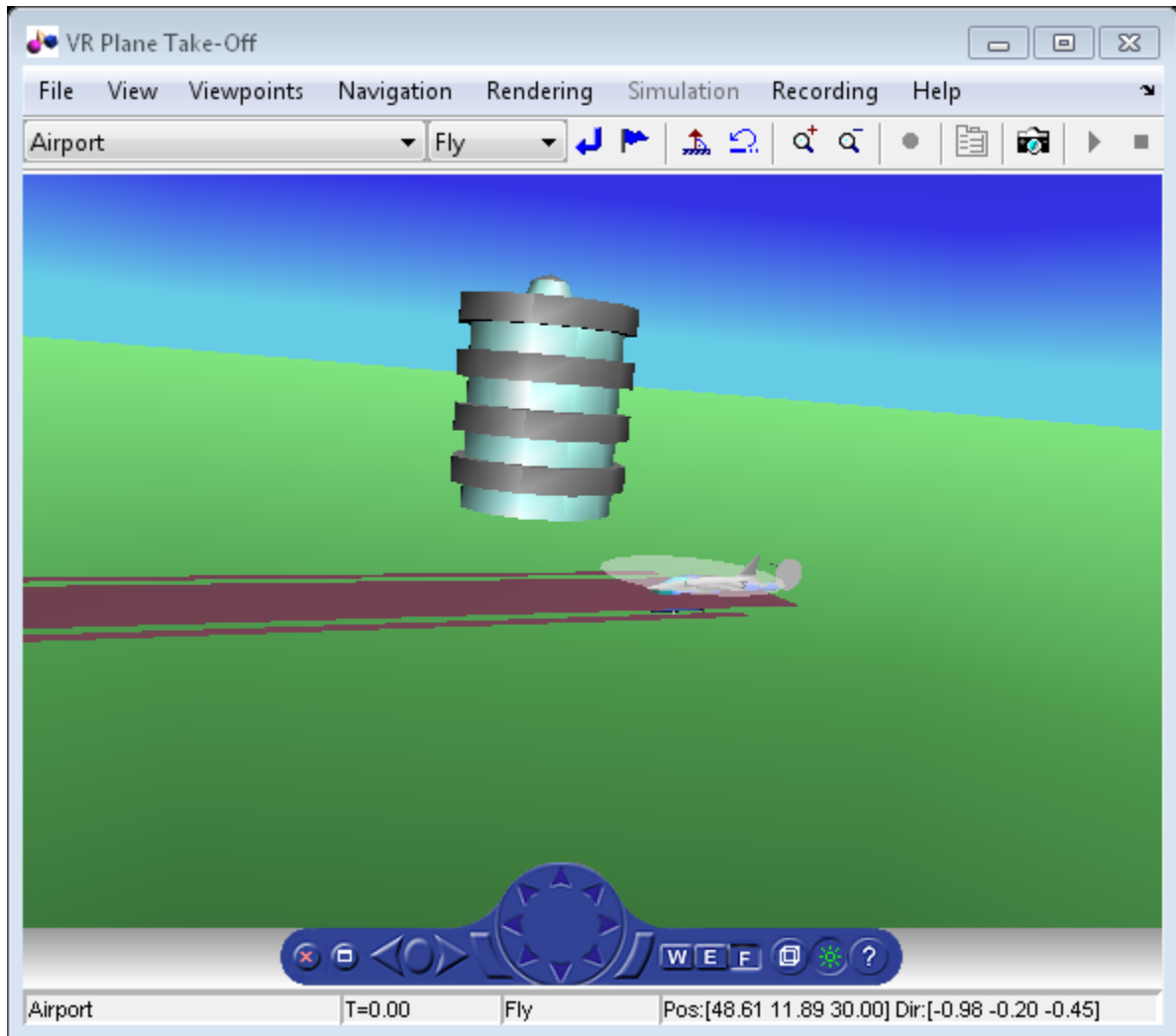

Another call to `nodeInfo` shows the newly added Node objects.

```
h.nodeInfo
```

```
Node Information  
1 Camera1
```

```
2 Plane
3 _v2
4 Block
5 Terminal
6 _v3
7 Lighthouse
8 _v1
9 Lynx
10 Lynx_Inline
```

Adjust newly added helicopter to sit on runway.

```
[~, idxLynx] = find(strcmp('Lynx',h.nodeInfo));
h.Node{idxLynx}.VRNode.translation = [0 1.5 0];
```

This code sets data properties for the chase helicopter. The 'TimeseriesSourceType' is the default 'Array6DoF', so no additional property changes are needed. The same coordinate transform function (vranimCustomTransform) is used for this node as the preceding node. The previous call to nodeInfo returned the node index (2).

```
load chaseData
h.Nodes{idxLynx}.TimeseriesSource = chaseData;
h.Nodes{idxLynx}.CoordTransformFcn = @vranimCustomTransform;
```

### Create New Viewpoint

This code uses the addViewpoint method to create a new viewpoint named 'chaseView'. The new viewpoint will appear in the viewpoint pulldown menu in the virtual reality window as "View From Helicopter". Another call to nodeInfo shows the newly added node objects. The node is created as a child of the chase helicopter.

```
h.addViewpoint(h.Nodes{idxLynx}.VRNode, 'children', 'chaseView', 'View From Helicopter');
```

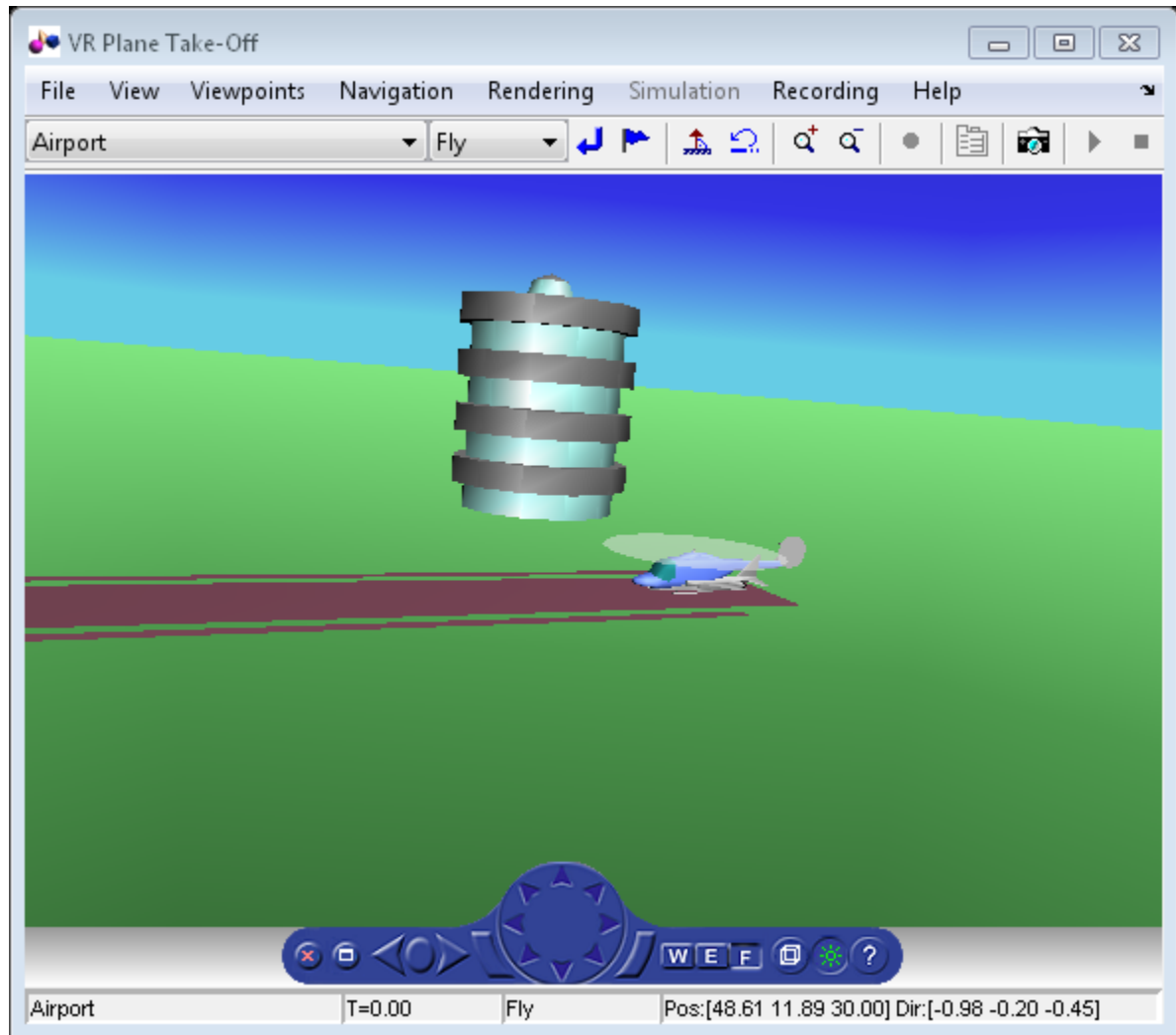

### Play Animation

The `play` method runs the simulation for the specified timeseries data.

```
h.play();
```

### Play Animation From Helicopter

This code sets the orientation of the viewpoint via the vrnode object associated with the node object for the viewpoint. In this case, it will change the viewpoint to look out the left side of the helicopter at the plane.

```
[~, idxChaseView] = find(strcmp('chaseView',h.nodeInfo));  
h.Nodes{idxChaseView}.VRNode.orientation = [0 1 0 convang(200,'deg','rad')];  
set(h.VRFigure,'Viewpoint','View From Helicopter');
```

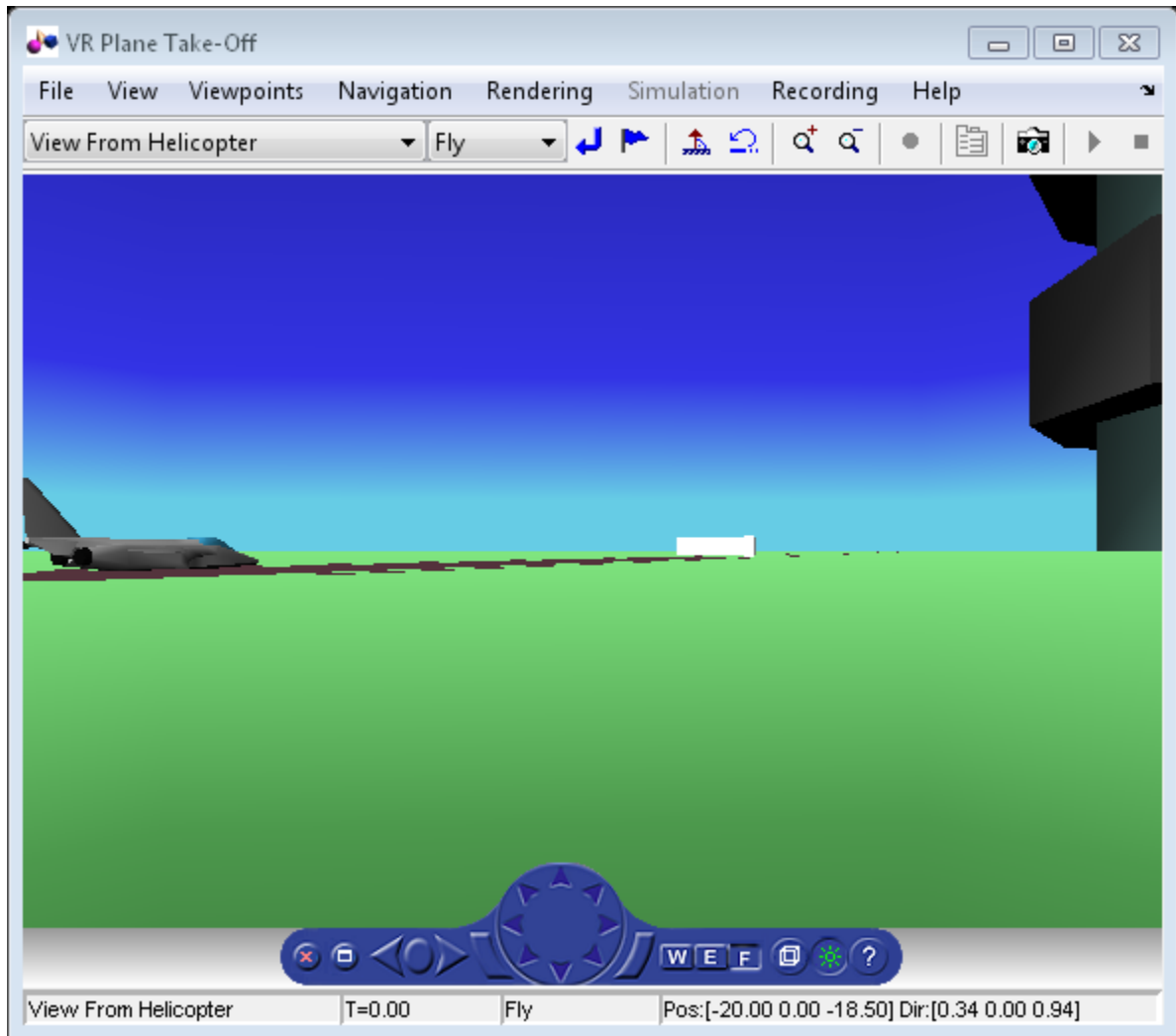

### Add ROUTE

This code calls the `addRoute` method to add a ROUTE command to connect the plane position to the Camera1 node. This will allow for the "Ride on the Plane" viewpoint to function as intended.

```
h.addRoute('Plane','translation','Camera1','translation');
```



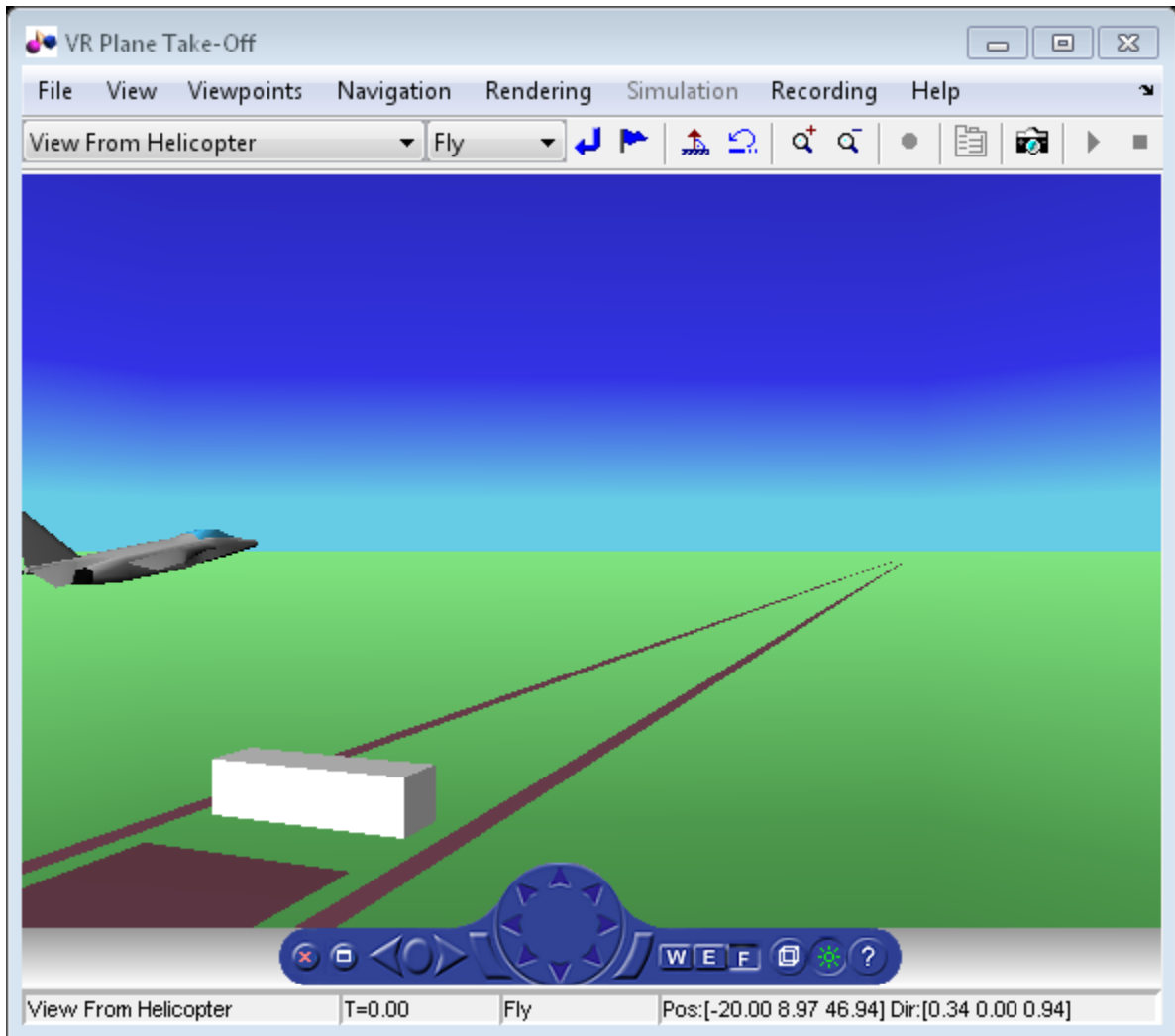

The scene from the helicopter viewpoint

This code plays the animation.

```
h.play();
```

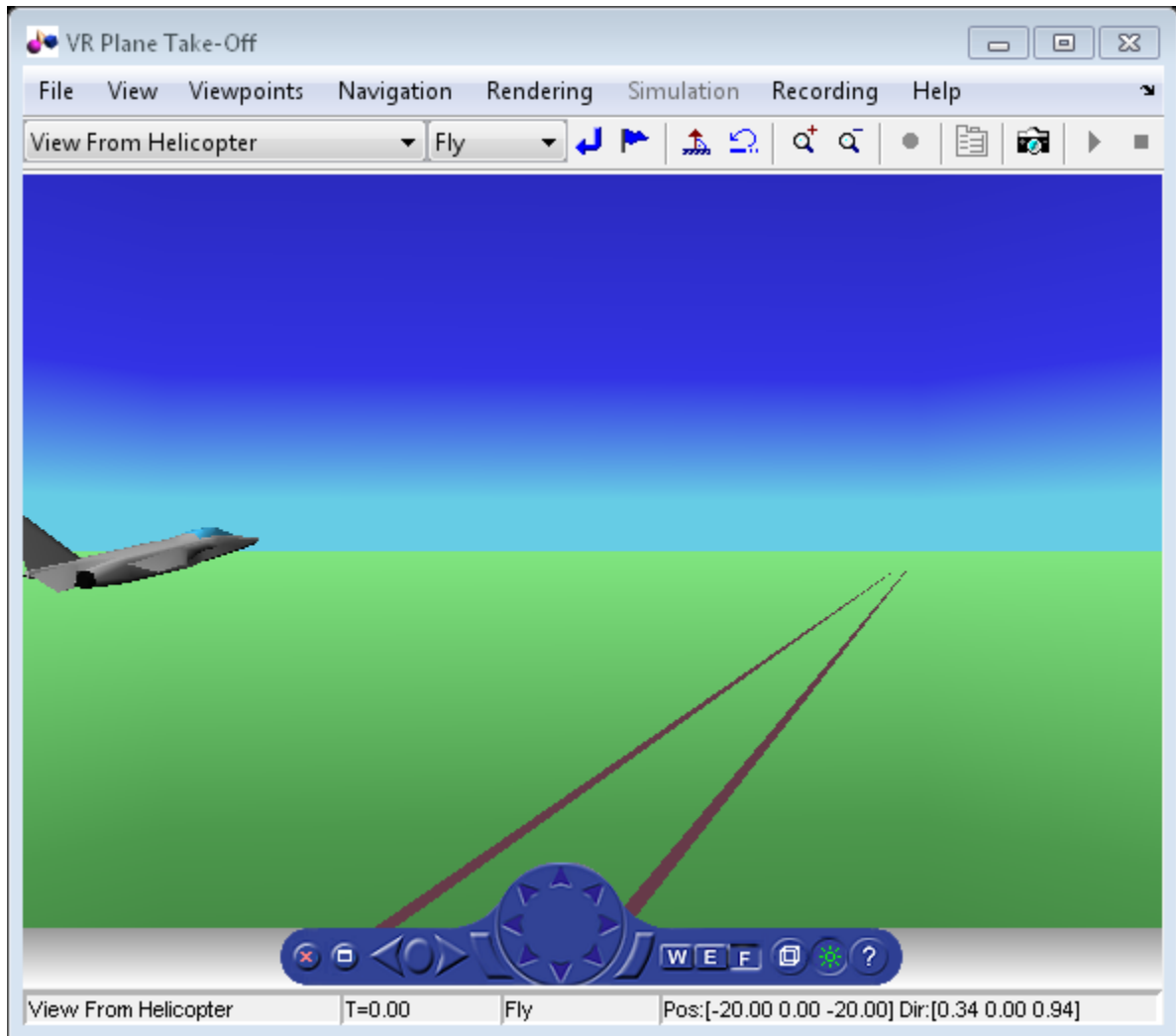

### Add Another Body

This code adds another helicopter to the scene. It also changes to another viewpoint to view all three bodies in the scene at once.

```
set(h.VRFigure, 'Viewpoint', 'See Whole Trajectory');
```

```
h.addNode('Lynx1',[matlabroot,'/toolbox/aero/astdemos/chaseHelicopter.wrl']);  
h.nodeInfo
```

Node Information

```
1 Camera1  
2 Plane  
3 _v2  
4 Block  
5 Terminal  
6 _v3  
7 Lighthouse  
8 _v1  
9 Lynx  
10 Lynx_Inline  
11 chaseView  
12 Lynx1  
13 Lynx1_Inline
```

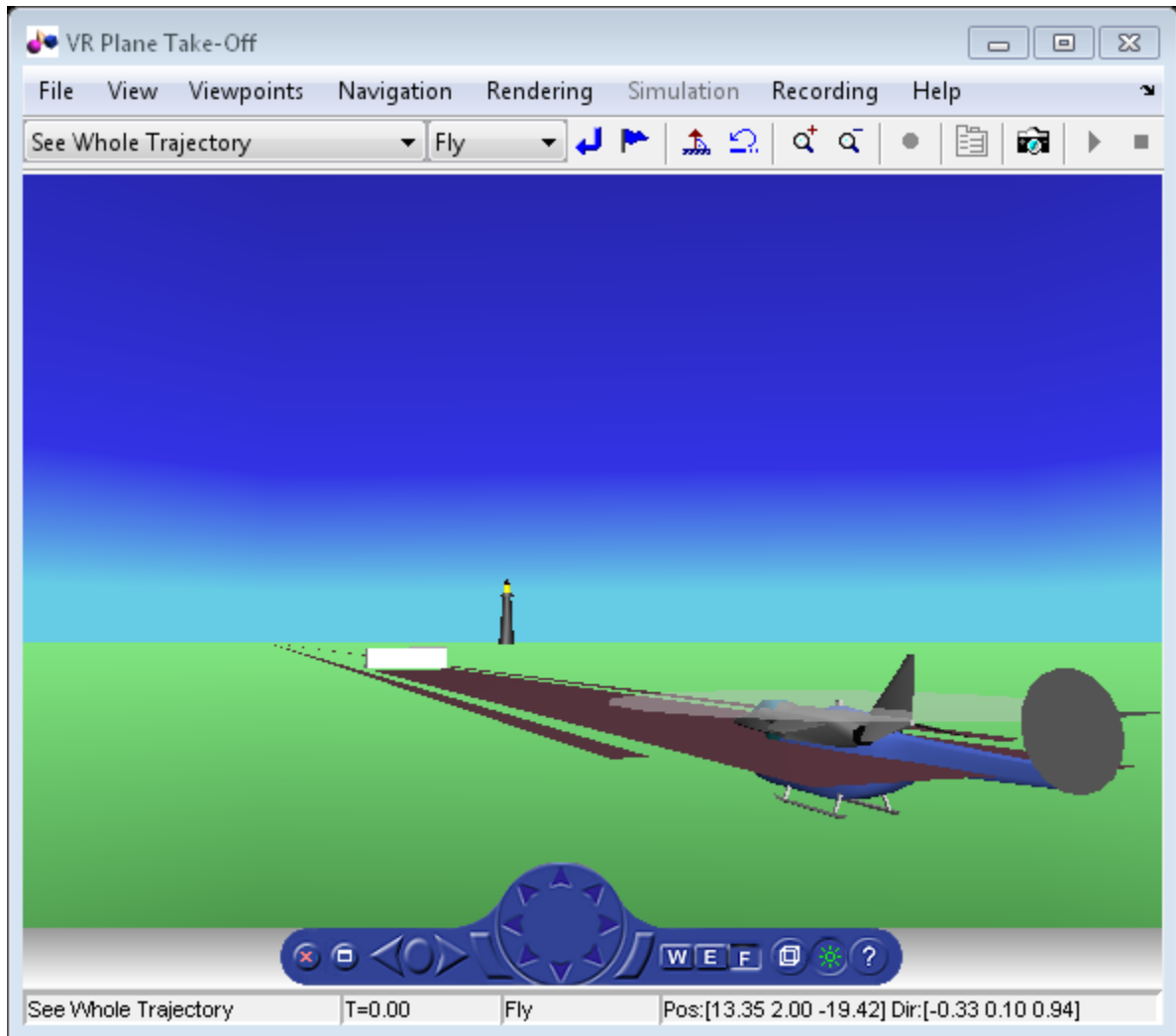

Adjust newly added helicopter to sit above runway.

```
[~, idxLynx1] = find(strcmp('Lynx1',h.nodeInfo));  
h.Node{idxLynx1}.VRNode.translation = [0 1.3 0];
```

## Remove Body

This code uses the `removeNode` method to remove the second helicopter. `removeNode` takes either the node name or node index (as obtained from `nodeInfo`). The associated inline node is removed as well.

```
h.removeNode('Lynx1');  
h.nodeInfo
```

Node Information

```
1 Camera1  
2 Plane  
3 _v2  
4 Block  
5 Terminal  
6 _v3  
7 Lighthouse  
8 _v1  
9 Lynx  
10 Lynx_Inline  
11 chaseView
```

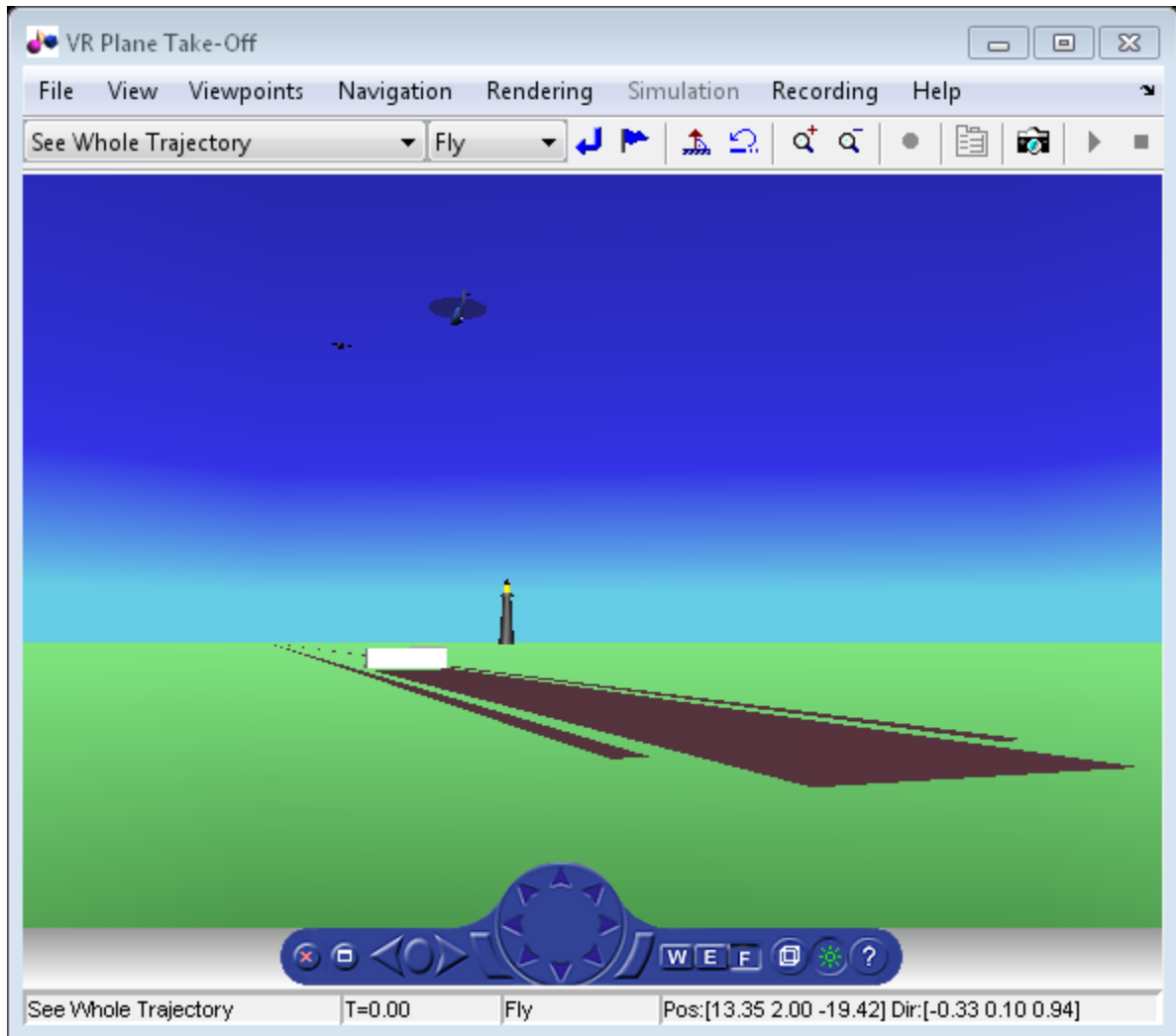

### Revert To Original World

The original filename is stored in the 'VRWorldOldFilename' property of the animation object. To bring up the original world, set 'VRWorldFilename' to the original name and reinitializing it.

```
h.VRWorldFilename = h.VRWorldOldFilename{1};
```

```
h.initialize();
```

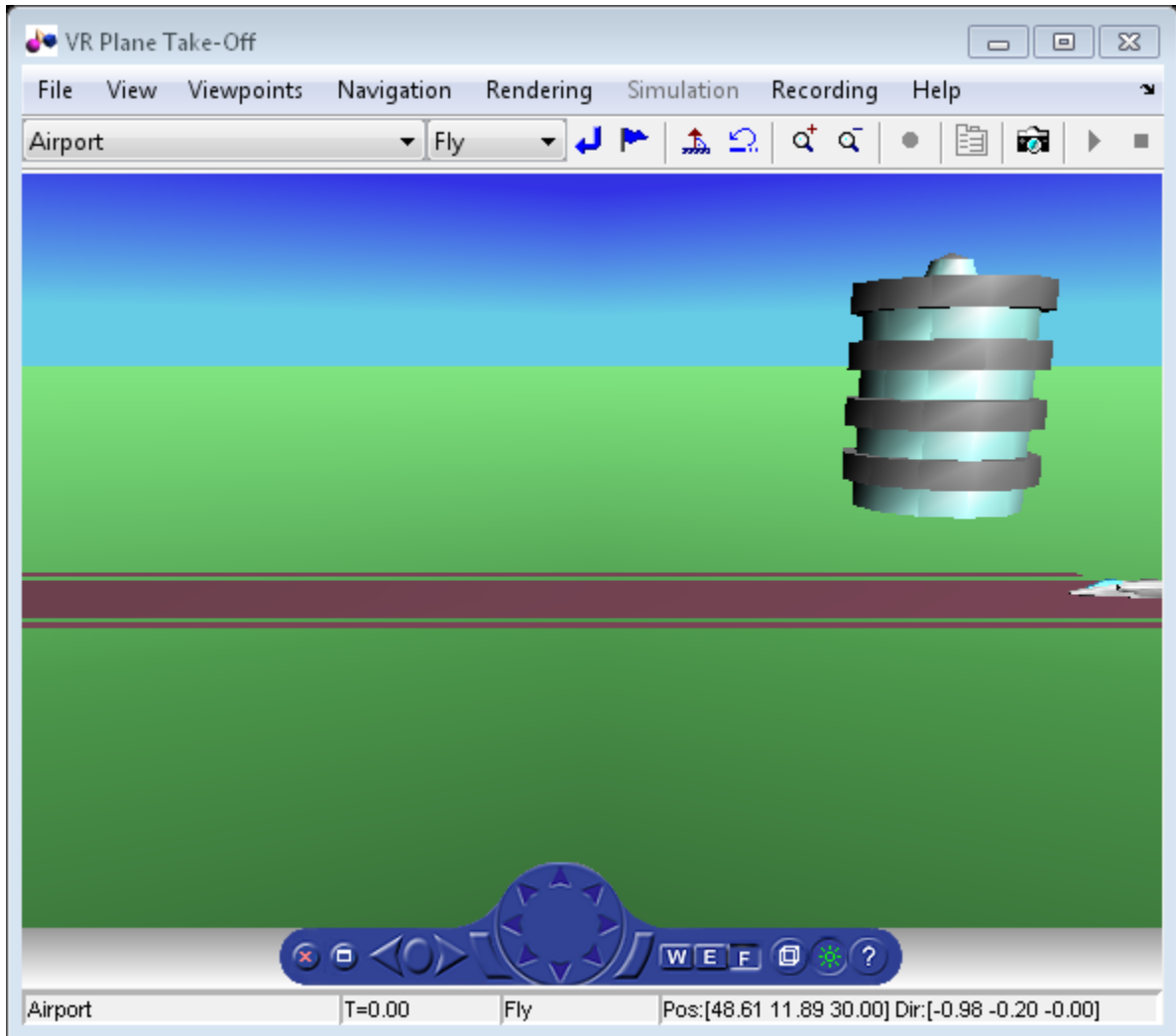

### Close and Delete World

To close and delete

```
h.delete();
```

## Aero.FlightGearAnimation Objects

The Aerospace Toolbox interface to the FlightGear flight simulator enables you to visualize flight data in a three-dimensional environment. The third-party FlightGear simulator is an open source software package available through a GNU® General Public License (GPL). This section describes how to obtain and install the third-party FlightGear flight simulator. It also describes how to play back 3-D flight data by using a FlightGear example, provided with your Aerospace Toolbox software.

In this section...
“About the FlightGear Interface” on page 2-52
“Configuring Your Computer for FlightGear” on page 2-53
“Install and Start FlightGear” on page 2-56
“Flight Simulator Interface Example” on page 2-57
“Running the Example” on page 2-59

### About the FlightGear Interface

The FlightGear flight simulator interface included with the Aerospace Toolbox product is a unidirectional transmission link from the MATLAB software to FlightGear. It uses FlightGear's published `net_fdm` binary data exchange protocol. Data is transmitted via UDP network packets to a running instance of FlightGear. The toolbox supports multiple standard binary distributions of FlightGear. For interface details, see “Flight Simulator Interface Example” on page 2-57.

FlightGear is a separate software entity that is not created, owned, or maintained by MathWorks.

- To report bugs in or request enhancements to the Aerospace Toolbox FlightGear interface, contact MathWorks technical support at <http://www.mathworks.com/support/>.
- To report bugs or request enhancements to FlightGear itself, go to [www.flightgear.org](http://www.flightgear.org) and use the contact page.

### Supported FlightGear Versions

The Aerospace Toolbox product supports the following FlightGear versions:

- v2.0



- v2.4
- v2.6
- v2.8
- v2.10
- v2.12
- v3.0
- v3.2
- v3.4
- v2016.1
- v2016.3

### **Obtaining FlightGear Software**

You can obtain FlightGear software from [www.flightgear.org](http://www.flightgear.org) in the download area or by ordering CDs from FlightGear. The download area contains extensive documentation for installation and configuration. Because FlightGear is an open source project, source downloads are also available for customization and porting to custom environments.

### **Configuring Your Computer for FlightGear**

You must have a high-performance graphics card with stable drivers to use FlightGear. For more information, see the FlightGear CD distribution or the hardware requirements and documentation areas of the FlightGear Web site, [www.flightgear.org](http://www.flightgear.org).

MathWorks tests of FlightGear performance and stability indicate sensitivity to computer video cards, driver versions, and driver settings. You must have OpenGL support with hardware acceleration activated. The OpenGL settings are particularly important. Without proper setup, performance can drop from about a 30 frames-per-second (fps) update rate to less than 1 fps.

### **Graphics Recommendations for Microsoft Windows**

For Windows® users, use the following graphics recommendations:

- A graphics card with acceptable OpenGL performance (as outlined at the FlightGear Web site, [www.flightgear.org](http://www.flightgear.org)).
- The latest tested and stable driver release for your video card. Test the driver thoroughly on a few computers before deploying to others.

For Microsoft® Windows XP systems running on x86 (32-bit) or AMD-64/EM64T chip architectures, the graphics card operates in the unprotected kernel space known as Ring Zero. Problems in the driver can cause the Windows operating system to lock or crash. Before buying a large number of computers for 3-D applications, with your vendor, test one or two computers to find a combination of hardware, operating system, drivers, and settings that are stable for your applications.

For more information, see [FlightGear Hardware Recommendations](#).

### Setting Up OpenGL Graphics on Windows

For complete information on Silicon Graphics OpenGL settings, refer to the documentation at the OpenGL Web site, [www.opengl.org](http://www.opengl.org).

Follow these steps to optimize your video card settings. Your driver's panes might look different.

- 1 Ensure that you have activated the OpenGL hardware acceleration on your video card. On Windows, access this configuration through **Start > Settings > Control Panel > Display**, which opens the following dialog box. Select the **Settings** tab.

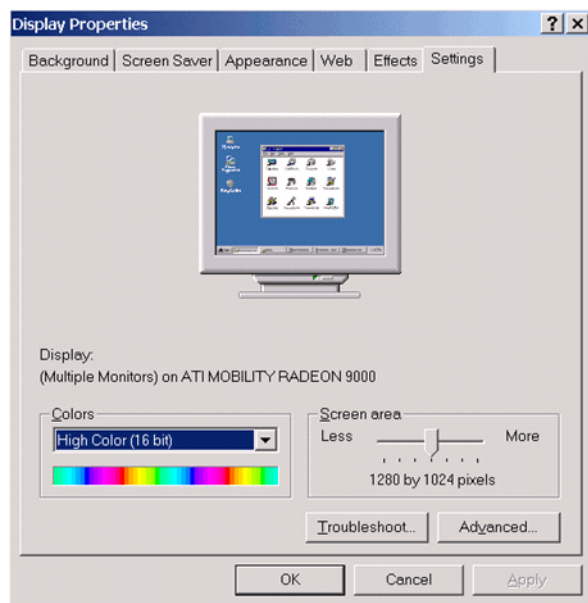

- 2 In the lower right of the dialog box, click the **Advanced** button, which opens the graphics card custom configuration dialog box. Go to the **OpenGL** tab. For an ATI Mobility Radeon 9000 video card, the **OpenGL** pane looks like the following graphic.

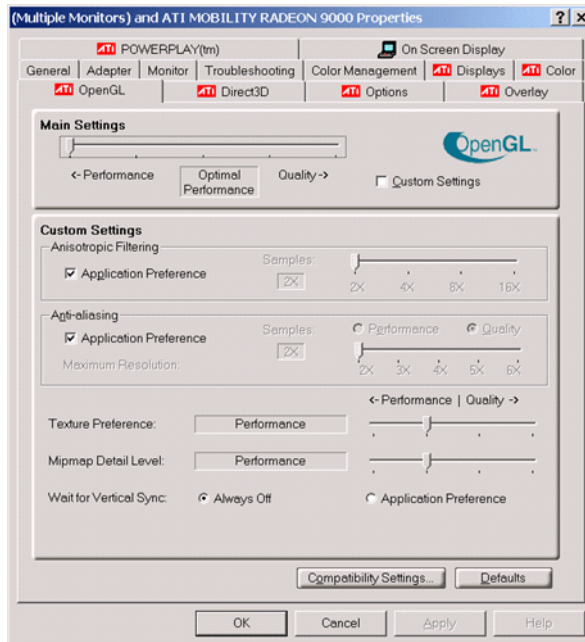

- 3 For best performance, near the top of the dialog box, move the **Main Settings** slider to the **Performance** end of the slider.
- 4 If stability is a problem, try other screen resolutions, other color depths in the **Displays** pane, and other OpenGL acceleration modes.

Many cards perform much better at 16 bits-per-pixel color depth (also known as 65536 color mode, 16-bit color). For example, on an ATI Mobility Radeon 9000 running a given model, 30 fps are achieved in 16-bit color mode, while 2 fps are achieved in 32-bit color mode.

### Setup on Linux, Mac OS X, and Other Platforms

FlightGear distributions are available for Linux<sup>®</sup>, Mac OS X, and other UNIX<sup>®</sup> platforms from the FlightGear Web site, [www.flightgear.org](http://www.flightgear.org). Installation on these platforms, like Windows, requires careful configuration of graphics cards and drivers. Consult the documentation and hardware requirements sections at the FlightGear Web site.

## Install and Start FlightGear

The extensive FlightGear documentation guides you through the installation. For complete installation instructions, consult the documentation section of the FlightGear Web site [www.flightgear.org](http://www.flightgear.org).

Note:

- Generous central processor speed, system and video RAM, and virtual memory are essential for good flight simulator performance.

For more information, see [http://wiki.flightgear.org/Hardware\\_recommendations](http://wiki.flightgear.org/Hardware_recommendations).

- Have sufficient disk space for the FlightGear download and installation.
- Before you install FlightGear, configure your computer graphics card. See the preceding section, “Configuring Your Computer for FlightGear” on page 2-53.
- Before installing FlightGear, shut down all running applications (including the MATLAB software).
- Install FlightGear in a folder path name composed of ASCII characters.
- The operational stability of FlightGear is especially sensitive during startup. It is best to not move, resize, mouse over, overlap, or cover up the FlightGear window until the initial simulation scene appears after the startup splash screen fades out.
- The current releases of FlightGear are optimized for flight visualization at altitudes below 100,000 feet. FlightGear does not work well or at all with very high altitude and orbital views.

The Aerospace Toolbox product supports FlightGear on a number of platforms (<http://www.mathworks.com/products/aerotb/requirements.html>). The following table lists the properties to be aware of before you start using FlightGear.

FlightGear Property	Folder Description	Platforms	Typical Location
FlightGearBase-Directory	FlightGear installation folder.	Windows	C:\Program Files\FlightGear (default)
		Linux	Directory into which you installed FlightGear
		Mac	/Applications

FlightGear Property	Folder Description	Platforms	Typical Location
			(folder into which you dragged the FlightGear icon)
GeometryModelName	Model geometry folder	Windows	C:\Program Files\FlightGear\data\Aircraft\HL20 (default)
		Linux	\$FlightGearBaseDirectory/-data/Aircraft/HL20
		Mac	\$FlightGearBaseDirectory/-FlightGear.app/Contents/-Resources/data/Aircraft/-HL20

## Flight Simulator Interface Example

The Aerospace Toolbox product provides an example named Displaying Flight Trajectory Data. This example shows you how you can visualize flight trajectories with FlightGear Animation object. The example is intended to be modified depending on the particulars of your FlightGear installation. Use this example to play back your own 3-D flight data with FlightGear.

Before attempting to simulate this model, you must have FlightGear installed and configured. See “About the FlightGear Interface” on page 2-52.

To run the example:

- Import the aircraft geometry into FlightGear.
- Run the example. The example performs the following steps:
  - Loads recorded trajectory data.
  - Creates a time series object from trajectory data.
  - Creates a FlightGearAnimation object.
- Modify the animation object properties, if needed.
- Create a run script for launching the FlightGear flight simulator.
- Start the FlightGear flight simulator.
- Play back the flight trajectory.

### Import the Aircraft Geometry into FlightGear

Before running the example, copy the aircraft geometry model into FlightGear. From the following procedures, choose the one appropriate for your platform. This section assumes that you have read “Install and Start FlightGear” on page 2-56.

If your platform is Windows:

- 1 Go to your installed FlightGear folder. Open the `data` folder, and then the `Aircraft` folder: `FlightGear\data\Aircraft\`.
- 2 If you have previously run the Aerospace Blockset NASA HL-20 with FlightGear Interface example, you might already have an `HL20` subfolder there.

Otherwise, copy the `HL20` folder from the `matlabroot\toolbox\aero\aedemos\` folder to the `FlightGear\data\Aircraft\` folder. This folder contains the preconfigured geometries for the HL-20 simulation and `HL20-set.xml`. The file `matlabroot\toolbox\aero\aedemos\HL20\models\HL20.xml` defines the geometry.

If your platform is Linux:

- 1 Go to your installed FlightGear folder. Open the `data` folder, then the `Aircraft` folder: `$FlightGearBaseDirectory/data/Aircraft/`.
- 2 If you have previously run the Aerospace Blockset NASA HL-20 with FlightGear Interface example, you might already have an `HL20` subfolder there. If that is the case, you do not have to do anything, because you can use the existing geometry model.

Otherwise, copy the `HL20` folder from the `matlabroot/toolbox/aero/aerodemos/` folder to the `$FlightGearBaseDirectory/data/Aircraft/` folder. This folder contains the preconfigured geometries for the HL-20 simulation and `HL20-set.xml`. The file `matlabroot/toolbox/aero/aerodemos/HL20/models/HL20.xml` defines the geometry.

If your platform is Mac:

- 1 Open a terminal.
- 2 List the contents of the `Aircraft` folder. For example, type:

```
ls $FlightGearBaseDirectory/data/Aircraft/
```

- 3** If you have previously run the Aerospace Blockset NASA HL-20 with FlightGear Interface example, you might already have an HL20 subfolder there. In this case, you do not have to do anything, because you can use the existing geometry model. Continue to “Running the Example” on page 2-24.

Otherwise, copy the HL20 folder from the

`matlabroot/toolbox/aero/aerodemos/`  
folder to the

`$FlightGearBaseDirectory/FlightGear.app/Contents/Resources/data/Aircraft/`  
folder. This folder contains the preconfigured geometries for the HL-20 simulation and `HL20-set.xml`. The file `matlabroot/toolbox/aero/aerodemos/HL20/models/HL20.xml` defines the geometry.

## Running the Example

- 1** Start the MATLAB software.
- 2** Enter `astfganim` in the MATLAB Command Window.

While running, the example performs several steps by issuing a series of commands.

## Flight Trajectory Data

### Loading Recorded Flight Trajectory Data

The flight trajectory data for this example is stored in a comma separated value formatted file. Using `dlmread`, the data is read from the file starting at row 1 and column 0, which omits the header information.

```
tdata = dlmread('asth120log.csv',',',1,0);
```

### Creating a Time Series Object from Trajectory Data

The time series object, `ts`, is created from the latitude, longitude, altitude, Euler angle data, and the time array in `tdata` using the MATLAB `timeseries` command. Latitude, longitude, and Euler angles are also converted from degrees to radians using the `convang` function.

```
ts = timeseries([convang(tdata(:,[3 2]),'deg','rad') ...  
               tdata(:,4) convang(tdata(:,5:7),'deg','rad')],tdata(:,1));
```

### Creating a FlightGearAnimation Object

This series of commands creates a `FlightGearAnimation` object:

- 1 Open a `FlightGearAnimation` object.

```
h = fganimation;
```

- 2 Set `FlightGearAnimation` object properties for the time series.

```
h.TimeseriesSourceType = 'Timeseries';  
h.TimeseriesSource = ts;
```

- 3 Set `FlightGearAnimation` object properties relating to `FlightGear`. These properties include the path to the installation folder, the version number, the aircraft geometry model, and the network information for the `FlightGear` flight simulator.

```
h.FlightGearBaseDirectory = 'C:\Program Files\FlightGear20163';  
h.FlightGearVersion = '2016.3';  
h.GeometryModelName = 'HL20';  
h.DestinationIpAddress = '127.0.0.1';
```



```
h.DestinationPort = '5502';
```

- 4 Set the initial conditions (location and orientation) for the FlightGear flight simulator.

```
h.AirportId = 'KSFO';
h.RunwayId = '10L';
h.InitialAltitude = 7224;
h.InitialHeading = 113;
h.OffsetDistance = 4.72;
h.OffsetAzimuth = 0;
```

- 5 Set the seconds of animation data per second of wall-clock time.

```
h.TimeScaling = 5;
```

- 6 Check the FlightGearAnimation object properties and their values.

```
get(h)
```

The example stops running and returns the FlightGearAnimation object, h:

```
TimeseriesSource: [1x1 timeseries]
TimeseriesSourceType: 'Timeseries'
TimeseriesReadFcn: @TimeseriesRead
TimeScaling: 5
FramesPerSecond: 12
FlightGearVersion: '2016.3'
OutputFileName: 'runfg.bat'
FlightGearBaseDirectory: 'C:\Program Files\FlightGear20163'
GeometryModelName: 'HL20'
DestinationIpAddress: '127.0.0.1'
DestinationPort: '5502'
AirportId: 'KSFO'
RunwayId: '10L'
InitialAltitude: 7224
InitialHeading: 113
OffsetDistance: 4.7200
OffsetAzimuth: 0
TStart: NaN
TFinal: NaN
Architecture: 'Default'
```

You can now set the object properties for data playback (see “Modifying the FlightGearAnimation Object Properties” on page 2-62).

## Modifying the FlightGearAnimation Object Properties

Modify the `FlightGearAnimation` object properties as needed. If your `FlightGear` installation folder is other than that in the example (for example, `FlightGear`), modify the `FlightGearBaseDirectory` property by issuing the following command:

```
h.FlightGearBaseDirectory = 'C:\Program Files\FlightGear';
```

Similarly, if you want to use a particular file name for the run script, modify the `OutputFileName` property.

Verify the `FlightGearAnimation` object properties:

```
get(h)
```

You can now generate the run script (see “Generating the Run Script” on page 2-62).

## Generating the Run Script

To start `FlightGear` with the initial conditions (location, date, time, weather, operating modes) that you want, it is best to create a run script by using the `GenerateRunScript` command:

```
GenerateRunScript(h)
```

By default, `GenerateRunScript` saves the run script as a text file named `runfg.bat`. You can specify a different name by modifying the `OutputFileName` property of the `FlightGearAnimation` object, as described in the previous step.

This file does not need to be generated each time the data is viewed, only when the initial conditions or `FlightGear` information changes.

You are now ready to start `FlightGear` (see “Starting the FlightGear Flight Simulator” on page 2-63).

---

**Note:** The `FlightGearBaseDirectory` and `OutputFileName` properties must be composed of ASCII characters.

---

## Installing Additional FlightGear Scenery

When you install the FlightGear software, the installation provides a basic level of scenery files. The FlightGear documentation guides you through installing scenery as part the general FlightGear installation.

If you need to install more FlightGear scenery files, see the instructions at <http://www.flightgear.org>. Those instructions describe how to install the additional scenery in a default location.

If you must install additional scenery in a non-standard location, try setting the `FG_SCENERY` environment variable in the script output from the `GenerateRunScript` function. For a description of the `FG_SCENERY` variable, see the documentation at <http://www.flightgear.org>.

---

**Note:** Each time that you run the `GenerateRunScript` function, it creates a new script. It overwrites any edits that you have added.

---

## Starting the FlightGear Flight Simulator

To start FlightGear from the MATLAB command prompt, use the `system` command to execute the run script. Provide the name of the output file created by `GenerateRunScript` as the argument:

```
system('runfg.bat &');
```

FlightGear starts in a separate window.

---

**Tip** With the FlightGear window in focus, press the **V** key to alternate between the different aircraft views: cockpit, helicopter, chase, and so on.

---

You are now ready to play back data (see “Playing Back the Flight Trajectory” on page 2-64).

---

**Tip:** If FlightGear uses more computer resources than you want, you can change its scheduling priority to a lesser one. For example, see commands like Windows `start` and Linux `nice` or their equivalents.

---

## Playing Back the Flight Trajectory

Once FlightGear is running, the FlightGearAnimation object can start to communicate with FlightGear. To animate the flight trajectory data, use the play command:

```
play(h)
```

The following illustration shows a snapshot of flight data playback in tower view without yaw.



# Add-On for Ephemeris and Geoid Data Support

---

## Add Ephemeris and Geoid Data for Aerospace Products

Add ephemeris and/or geoid data to use it with the Aerospace Toolbox functions and Aerospace Blockset blocks. You can add data for these functions and blocks.

Aerospace Toolbox Functions	Aerospace Blockset Blocks
geoidheight	Geoid Height
<b>Note:</b> Only for the EGM2008 Geopotential Model. Aerospace Toolbox provides EGM96 Geopotential Model data.	<b>Note:</b> Only for the EGM2008 Geopotential Model. Aerospace Toolbox provides EGM96 Geopotential Model data.
earthNutation	Earth Nutation
moonLibration	Moon Libration
planetEphemeris	Planetary Ephemeris

To add ephemeris and geoid data for these functions and blocks.

- 1 In a MATLAB Command Window, type:

```
aeroDataPackage
```

The Add-On Explorer starts.

- 2 Select the data you want to add, for example:
  - Geoid Data for Aerospace Toolbox
  - Ephemeris Data for Aerospace Toolbox

**Refine by Source**  
 MathWorks 2

**Refine by Type**  
 Features 2

**Refine by Product Family**  
 MATLAB 2

2 RESULTS

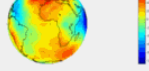
 **Geoid Data for Aerospace Toolbox** version 16.1.0.0 by MathWorks Aerospace Products Team  
Geoid Data for Aerospace Toolbox  
MathWorks Feature

 **Ephemeris Data for Aerospace Toolbox** version 16.1.0.0 by MathWorks Aerospace Products Team  
Ephemeris Data for Aerospace Toolbox  
MathWorks Feature

3 On the data page, click the **Install** button.

---

**Note:** You must have write privileges for the folder to which you are adding data.

---

To check for updates, repeat this process when a new version of MATLAB software is released. You can also check for updates between releases using this process.





# Alphabetical List

---

# addBody

**Class:** Aero.Animation

**Package:** Aero

Add loaded body to animation object and generate its patches

## Syntax

```
idx = addBody(h,b)  
idx = h.addBody(b)
```

## Description

`idx = addBody(h,b)` and `idx = h.addBody(b)` add a loaded body, `b`, to the animation object `h` and generates its patches. `idx` is the index of the body to be added.

## Input Arguments

<code>h</code>	Animation object.
<code>b</code>	Loaded body.

## Output Arguments

<code>idx</code>	Index of the body to be added.
------------------	--------------------------------

## Examples

Add a second body to the list that is a pointer to the first body. This means that if you change the properties of one body, the properties of the other body change correspondingly.

```
h = Aero.Animation;
```

```
idx1 = h.createBody('pa24-250_orange.ac', 'Ac3d');  
b = h.Bodies{1};  
idx2 = h.addBody(b);
```

## addNode (Aero.VirtualRealityAnimation)

Add existing node to current virtual reality world

### Syntax

```
addNode(h, node_name, wrl_file)
h.addNode(node_name, wrl_file)
```

### Description

`addNode(h, node_name, wrl_file)` and `h.addNode(node_name, wrl_file)` add an existing node, `node_name`, to the current virtual reality world. The `wrl_file` is the file from which the new node is taken. `addNode` adds a new node named `node_name`, which contains (or points to) the `wrl_file`. `node_name` must be unique from other node names in the same `.wrl` file. `wrl_file` must contain the node to be added. You must specify the full path for this file. The `vrnode` object associated with the node object must be defined using a `DEF` statement in the `.wrl` file. This method creates a node object on the world of type `Transform`.

When you use the `addNode` method to add a node, all the objects in the `.wrl` file will be added to the virtual reality animation object under one node. If you want to add separate nodes for the objects in the `.wrl` file, place each node in a separate `.wrl` file.

### Examples

Add node to world defined in `chaseHelicopter.wrl`.

```
h = Aero.VirtualRealityAnimation;
h.VRWorldFilename = [matlabroot, '/toolbox/aero/astdemos/asttkoff.wrl'];
copyfile(h.VRWorldFilename, [tempdir, 'asttkoff.wrl'], 'f');
h.VRWorldFilename = [tempdir, 'asttkoff.wrl'];
h.initialize();
h.addNode('Lynx', [matlabroot, '/toolbox/aero/astdemos/chaseHelicopter.wrl']);
```

### See Also

[Aero.Node](#) | [move](#) | [removeNode](#) | [updateNodes](#) |  
[Aero.VirtualRealityAnimation](#)

**Introduced in R2007b**

## **addRoute (Aero.VirtualRealityAnimation)**

Add VRML ROUTE statement to virtual reality animation

### **Syntax**

```
addRoute(h, nodeOut, eventOut, nodeIn, eventIn)  
h.addRoute(nodeOut, eventOut, nodeIn, eventIn)
```

### **Description**

`addRoute(h, nodeOut, eventOut, nodeIn, eventIn)` and `h.addRoute(nodeOut, eventOut, nodeIn, eventIn)` add a VRML ROUTE statement to the virtual reality animation, where `nodeOut` is the node from which information is routed, `eventOut` is the event (property), `nodeIn` is the node to which information is routed, and `eventIn` is the receiving event (property).

### **Examples**

Add a ROUTE command to connect the Plane position to the Camera1 node.

```
h = Aero.VirtualRealityAnimation;  
h.VRWorldFilename = [matlabroot, '/toolbox/aero/astdemos/asttkoff.wrl'];  
copyfile(h.VRWorldFilename, [tempdir, 'asttkoff.wrl'], 'f');  
h.VRWorldFilename = [tempdir, 'asttkoff.wrl'];  
h.initialize();  
h.addNode('Lynx', [matlabroot, '/toolbox/aero/astdemos/chaseHelicopter.wrl']);  
h.addRoute('Plane', 'translation', 'Camera1', 'translation');
```

### **See Also**

`addViewpoint`

**Introduced in R2007b**

# addViewpoint (Aero.VirtualRealityAnimation)

Add viewpoint for virtual reality animation

## Syntax

```
addViewpoint(h, parent_node, parent_field, node_name)
h.addViewpoint(parent_node, parent_field, node_name)
addViewpoint(h, parent_node, parent_field, node_name, description)
h.addViewpoint(parent_node, parent_field, node_name, description)
addViewpoint(h, parent_node, parent_field, node_name, description,
position)
h.addViewpoint(parent_node, parent_field, node_name, description,
position)
addViewpoint(h, parent_node, parent_field, node_name, description,
position, orientation)
h.addViewpoint(parent_node, parent_field, node_name, description,
position, orientation)
```

## Description

`addViewpoint(h, parent_node, parent_field, node_name)` and `h.addViewpoint(parent_node, parent_field, node_name)` add a viewpoint named `node_name` whose `parent_node` is the parent node field of the `vrnode` object and whose `parent_field` is a valid parent field of the `vrnode` object to the virtual world animation object, `h`.

`addViewpoint(h, parent_node, parent_field, node_name, description)` and `h.addViewpoint(parent_node, parent_field, node_name, description)` add a viewpoint named `node_name` whose `parent_node` is the parent node field of the `vrnode` object and whose `parent_field` is a valid parent field of the `vrnode` object to the virtual world animation object, `h`. `description` is the character vector you want to describe the viewpoint.

`addViewpoint(h, parent_node, parent_field, node_name, description, position)` and `h.addViewpoint(parent_node, parent_field, node_name, description, position)` add a viewpoint named `node_name` whose `parent_node`

is the parent node field of the `vrnode` object and whose `parent_field` is a valid parent field of the `vrnode` object to the virtual world animation object, `h.description` is the character vector you want to describe the viewpoint and `position` is the position of the viewpoint. Specify `position` using VRML coordinates (`x y z`).

`addViewpoint(h, parent_node, parent_field, node_name, description, position, orientation)` and `h.addViewpoint(parent_node, parent_field, node_name, description, position, orientation)` add a viewpoint named `node_name` whose `parent_node` is the parent node field of the `vrnode` object and whose `parent_field` is a valid parent field of the `vrnode` object to the virtual world animation object, `h.description` is the character vector you want to describe the viewpoint, `position` is the position of the viewpoint, and `orientation` is the orientation of the viewpoint. Specify `position` using VRML coordinates (`x y z`). Specify `orientation` in a VRML axes angle format (`x y z Θ`).

---

**Note:** If you call `addViewpoint` with only the `description` argument, you must set the `position` and `orientation` of the viewpoint with the `Simulink 3D Animation vrnode/setfield` function. This requires you to use VRML coordinates.

---

## Examples

Add a viewpoint named `chaseView`.

```
h = Aero.VirtualRealityAnimation;
h.VRWorldFilename = [matlabroot, '/toolbox/aero/astdemos/asttkoff.wrl'];
copyfile(h.VRWorldFilename, [tempdir, 'asttkoff.wrl'], 'f');
h.VRWorldFilename = [tempdir, 'asttkoff.wrl'];
h.initialize();
h.addViewpoint(h.Nodes{2}.VRNode, 'children', 'chaseView', 'View From Helicopter');
```

## See Also

`addRoute` | `removeViewpoint`

Introduced in R2007b



# Aero.Animation class

**Package:** Aero

Visualize aerospace animation

## Description

Use the Aero.Animation class to visualize flight data without any other tool or toolbox. You only need the Aerospace Toolbox to visualize this data.

## Construction

Aero.Animation

Construct animation object

## Methods

addBody

Add loaded body to animation object and generate its patches

createBody

Create body and its associated patches in animation

delete

Destroy animation object

hide

Hide animation figure

initialize

Create animation object figure and axes and build patches for bodies

initIfNeeded

Initialize animation graphics if needed

moveBody

Move body in animation object

play

Animate **Aero.Animation** object given position/angle time series

removeBody

Remove one body from animation

show

Show animation object figure

updateBodies

Update bodies of animation object

updateCamera

Update camera in animation object

## Properties

Bodies

Specify name of animation object

Camera

Specify camera that animation object contains

Figure

Specify name of figure object

FigureCustomizationFcn

Specify figure customization function

FramesPerSecond

Animation rate

Name

Specify name of animation object

TCurrent

Current time

TFinal

End time

TimeScaling

Scaling time

TStart

Start time

VideoCompression

Video recording compression file type

VideoFileName

Video recording file name

VideoQuality

Video recording quality

VideoRecord

Video recording

VideoTFinal

Video recording stop time for scheduled recording

VideoTStart

Video recording start time for scheduled recording

## See Also

[Aero.FlightGearAnimation](#) | [Aero.VirtualRealityAnimation](#)

## Topics

“Aero.Animation Objects” on page 2-24

# Aero.Animation

**Class:** Aero.Animation

**Package:** Aero

Construct animation object

## Syntax

```
h = Aero.Animation
```

## Description

`h = Aero.Animation` constructs an animation object. The animation object is returned to `h`.

---

**Note:** The `Aero.Animation` constructor does not retain the properties of previously created animation objects, even those that you have saved to a MAT-file. This means that subsequent calls to the animation object constructor always create animation objects with default properties.

---

## Examples

```
h=Aero.Animation
```

## Aero.Body

Create body object for use with animation object

### Syntax

```
h = Aero.Body
```

### Description

`h = Aero.Body` constructs a body for an animation object. The animation object is returned in `h`. To use the `Aero.Body` object, you typically:

- 1 Create the animation body.
- 2 Configure or customize the body object.
- 3 Load the body.
- 4 Generate patches for the body (requires an axes from a figure).
- 5 Set time series data source.
- 6 Move or update the body.

By default, an `Aero.Body` object natively uses aircraft  $x$ - $y$ - $z$  coordinates for the body geometry and the time series data. It expects the rotation order  $z$ - $y$ - $x$  ( $\psi$ ,  $\theta$ ,  $\phi$ ).

Convert time series data from other coordinate systems on the fly by registering a different `CoordTransformFcn` function.

### Constructor Summary

Constructor	Description
Body	Construct body object for use with animation object.

### Method Summary

Method	Description
<code>findstartstoptimes</code>	Return start and stop times of time series data.

Method	Description
generatePatches	Generate patches for body with loaded face, vertex, and color data.
load	Get geometry data from source.
move	Change Aero.Body position and orientation.
update	Changes body position and orientation versus time data.

## Property Summary

Property	Description	Values
CoordTransformFcn	Specify a function that controls the coordinate transformation.	Character vector
Name	Specify name of body.	
Position	Specify position of body.	MATLAB array
Rotation	Specify rotation of body.	MATLAB array
Geometry	Specify geometry of body.	handle
PatchGenerationFcn	Specify patch generation function.	MATLAB array
PatchHandles	Specify patch handles.	MATLAB array
ViewingTransform	Specify viewing transform.	MATLAB array
TimeseriesSource	Specify time series source.	MATLAB array
TimeseriesSource-Type	Specify the type of time series data stored in 'TimeseriesSource'. Five values are available. They are listed in the following table. The default value is 'Array6DoF'.	Character vector
TimeseriesReadFcn	Specify time series read function.	MATLAB array

The time series data, stored in the property 'TimeseriesSource', is interpreted according to the 'TimeseriesSourceType' property, which can be one of:

'Timeseries'	MATLAB time series data with six values per time:  lat lon alt phi theta psi  The values are resampled.
'StructureWithTime'	Simulink struct with time (for example, Simulink root output logging 'Structure with time'): <ul style="list-style-type: none"><li>• signals(1).values: lat lon alt</li><li>• signals(2).values: phi theta psi</li></ul> Signals are linearly interpolated vs. time using interp1.
'Array6DoF'	A double-precision array in n rows and 7 columns for 6-DoF data: time lat lon alt phi theta psi. If a double-precision array of 8 or more columns is in 'TimeseriesSource', the first 7 columns are used as 6-DoF data.
'Array3DoF'	A double-precision array in n rows and 4 columns for 3-DoF data: time lat alt theta. If a double-precision array of 5 or more columns is in 'TimeseriesSource', the first 4 columns are used as 3-DoF data.
'Custom'	Position and angle data is retrieved from 'TimeseriesSource' by the currently registered 'TimeseriesReadFcn'.

### See Also

Aero.Geometry

Introduced in R2007a

# Aero.Camera

Construct camera object for use with animation object

## Syntax

`h = Aero.Camera`

## Description

`h = Aero.Camera` constructs a camera object `h` for use with an animation object. The camera object uses the registered coordinate transform. By default, this is an aerospace body coordinate system. Axes of custom coordinate systems must be orthogonal.

By default, an `Aero.Body` object natively uses aircraft  $x-y-z$  coordinates for the body geometry and the time series data. Convert time series data from other coordinate systems on the fly by registering a different `CoordTransformFcn` function.

## Constructor Summary

Constructor	Description
Camera	Construct camera object for use with animation object.

## Method Summary

Method	Description
update	Update camera position based on time and position of other <code>Aero.Body</code> objects.

## Property Summary

Property	Description	Values
CoordTransformFcn	Specify a function that controls the coordinate transformation.	MATLAB array
PositionFcn	Specify a function that controls the position of a camera relative to an animation body.	MATLAB array
Position	Specify position of camera.	MATLAB array [ -150, -50, 0]
Offset	Specify offset of camera.	MATLAB array [ -150, -50, 0]
AimPoint	Specify aim point of camera.	MATLAB array [ 0, 0, 0]
UpVector	Specify up vector of camera.	MATLAB array [ 0, 0, -1]
ViewAngle	Specify view angle of camera.	MATLAB array {3}
ViewExtent	Specify view extent of camera.	MATLAB array {[ -50, 50]}
xlim	Specify x-axis limit of camera.	MATLAB array {[ -50, 50]}
ylim	Specify y-axis limit of camera.	MATLAB array {[ -50, 50]}
zlim	Specify z-axis limit of camera.	MATLAB array {[ -50, 50]}
PrevTime	Specify previous time of camera.	MATLAB array {0}
UserData	Specify custom data.	MATLAB array {[ ]}

## See Also

Aero.Geometry

Introduced in R2007a



# aeroDataPackage

Start Add-On Explorer to download, install, or uninstall aerospace-specific data

## Syntax

```
aeroDataPackage
```

## Description

aeroDataPackage opens Add-On Explorer. To see a list of available data, run Add-On Explorer and select the data you want.

## Examples

### Start Add-On Explorer

Start Add-On Explorer to add data.

```
aeroDataPackage
```

The Add-On Explorer starts. Follow the instructions to download your data.

- “Add Ephemeris and Geoid Data for Aerospace Products” on page 3-2

## See Also

### Topics

“Add Ephemeris and Geoid Data for Aerospace Products” on page 3-2

**Introduced in R2014a**

# Aero.FlightGearAnimation

Construct FlightGear animation object

## Syntax

```
h = Aero.FlightGearAnimation
```

## Description

`h = Aero.FlightGearAnimation` constructs a FlightGear animation object. The FlightGear animation object is returned to `h`.

## Constructor

Method	Description
<code>fganimation</code>	Construct FlightGear animation object.

## Method Summary

Method	Description
<code>ClearTimer</code>	Clear and delete timer for animation of FlightGear flight simulator.
<code>delete</code>	Destroy FlightGear animation object.
<code>GenerateRunScr</code>	Generate run script for FlightGear flight simulator.
<code>initialize</code>	Set up FlightGear animation object.
<code>play</code>	Animate FlightGear flight simulator using given position/angle time series.
<code>SetTimer</code>	Set name of timer for animation of FlightGear flight simulator.
<code>update</code>	Update position data to FlightGear animation object.

## Property Summary

Properties	Description
TimeseriesSource	Specify variable that contains the time series data.
TimeseriesSource-Type	Specify the type of time series data stored in 'TimeseriesSource'. Five values are available. They are listed in the 'TimeseriesSourceType' property table. The default value is 'Array6DoF'.
TimeseriesReadFcn	Specify a function to read the time series data if 'TimeseriesSourceType' is 'Custom'.
TimeScaling	Specify the seconds of animation data per second of wall-clock time. The default ratio is 1.
FramesPerSecond	Specify the number of frames per second used to animate the 'TimeseriesSource'. The default value is 12 frames per second.
FlightGearVersion	Select your FlightGear software version: v2016.3, v2016.1, v3.4, v3.2, v3.0, v2.12, v2.10, v2.8, v2.6, v2.4, or '2.0'. The default version is the latest version.
	<hr/> <p><b>Note:</b> If you are using a FlightGear version older than 2.0, the software returns a warning when you use the <code>initialize</code> method. Consider upgrading your FlightGear version. For more information, see “Supported FlightGear Versions” on page 2-52.</p> <hr/>
OutputFileName	Specify the name of the output file. The file name is the name of the command you will use to start FlightGear with these initial parameters. The default value is 'runfg.bat'.
	<hr/> <p><b>Note:</b> The run script file name must be composed of ASCII characters.</p> <hr/>
FlightGearBase-Directory	Specify the name of your FlightGear installation folder. The default value is 'D:\Applications\FlightGear'.

Properties	Description
	<b>Note:</b> FlightGear must be installed in a folder path name composed of ASCII characters.
GeometryModelName	Specify the name of the folder containing the desired model geometry in the <i>FlightGear</i> \data\Aircraft folder. The default value is 'HL20'.
DestinationIp-Address	Specify your destination IP address. The default value is '127.0.0.1'.
DestinationPort	Specify your network flight dynamics model (fdm) port. This destination port should be an unused port that you can use when you launch FlightGear. The default value is '5502'.
AirportId	Specify the airport ID. The list of supported airports is available in the FlightGear interface, under <b>Location</b> . The default value is 'KSFO'.
RunwayId	Specify the runway ID. The default value is '10L'.
InitialAltitude	Specify the initial altitude of the aircraft, in feet. The default value is 7224 feet.
InitialHeading	Specify the initial heading of the aircraft, in degrees. The default value is 113 degrees.
OffsetDistance	Specify the offset distance of the aircraft from the airport, in miles. The default value is 4.72 miles.
OffsetAzimuth	Specify the offset azimuth of the aircraft, in degrees. The default value is 0 degrees.
TStart	Specify start time as a double.
TFinal	Specify end time as a double.
Architecture	Specify the architecture the FlightGear software is running on. <code>GenerateRunScript</code> takes this setting into account when generating the bash run script to start FlightGear. The platforms are listed in the 'Architecture' table. The default value is 'Default'.

The time series data, stored in the property 'TimeseriesSource', is interpreted according to the 'TimeseriesSourceType' property, which can be one of:

'Timeseries'            MATLAB time series data with six values per time:

```
lat lon alt phi theta psi
```

The values are resampled.

'StructureWithTime' Simulink struct with time (for example, Simulink root output logging 'Structure with time'):

- signals(1).values: lat lon alt
- signals(2).values: phi theta psi

Signals are linearly interpolated vs. time using `interp1`.

'Array6DoF' A double-precision array in  $n$  rows and 7 columns for 6-DoF data: time lat lon alt phi theta psi. If a double-precision array of 8 or more columns is in 'TimeseriesSource', the first 7 columns are used as 6-DoF data.

'Array3DoF' A double-precision array in  $n$  rows and 4 columns for 3-DoF data: time lat alt theta. If a double-precision array of 5 or more columns is in 'TimeseriesSource', the first 4 columns are used as 3-DoF data.

'Custom' Position and angle data is retrieved from 'TimeseriesSource' by the currently registered 'TimeseriesReadFcn'.

Specify one of these values for the `Architecture` property:

'Default' Architecture the MATLAB software is currently running on. If the property has this value, `GenerateRunScript` creates a bash file that can work in the architecture that MATLAB is currently running on.

'Win32' Windows (32-bit) architecture.

'Win64' Windows (64-bit) architecture.

'Mac' Mac OS X (64-bit) architecture.

'Linux' Linux (64-bit) architecture.

## Examples

Construct a FlightGear animation object, `h`:

```
h = fanimation
```

## **See Also**

`play` | `fanimation` | `generaterunscript`

**Introduced in R2007a**

# Aero.Geometry

Construct 3-D geometry for use with animation object

## Syntax

```
h = Aero.Geometry
```

## Description

`h = Aero.Geometry` defines a 3-D geometry for use with an animation object.

This object supports the attachment of transparency data from an Ac3d file to patch generation.

## Constructor Summary

Constructor	Description
Geometry	Construct 3-D geometry for use with animation object.

## Method Summary

Method	Description
read	Read geometry data using current reader.

## Property Summary

Property	Description	Values
Name	Specify name of geometry.	Character vector

Property	Description	Values										
Source	Specify geometry data source.	{['Auto'], 'Variable', 'MatFile', 'Ac3dFile', 'Custom'}										
Reader	Specify geometry reader.	MATLAB array										
FaceVertexColorData	Specify the color of the geometry face vertex.	MATLAB structure with the following fields <table border="0" style="margin-left: 20px;"> <tr> <td style="padding-right: 20px;">name</td> <td>Character vector that contains the name of the geometry being loaded.</td> </tr> <tr> <td>faces</td> <td>See Faces on Patch Properties.</td> </tr> <tr> <td>vertices</td> <td>See Vertices on Patch Properties.</td> </tr> <tr> <td>cdata</td> <td>See CData on Patch Properties.</td> </tr> <tr> <td>alpha</td> <td>See FaceVertexAlphaData on Patch Properties.</td> </tr> </table>	name	Character vector that contains the name of the geometry being loaded.	faces	See Faces on Patch Properties.	vertices	See Vertices on Patch Properties.	cdata	See CData on Patch Properties.	alpha	See FaceVertexAlphaData on Patch Properties.
name	Character vector that contains the name of the geometry being loaded.											
faces	See Faces on Patch Properties.											
vertices	See Vertices on Patch Properties.											
cdata	See CData on Patch Properties.											
alpha	See FaceVertexAlphaData on Patch Properties.											

## See Also

read

Introduced in R2007a



# Aero.Node

Create node object for use with virtual reality animation

## Syntax

```
h = Aero.Node
```

## Description

`h = Aero.Node` creates a node object for use with virtual reality animation. Typically, you do not need to create a node object with this method. This is because the `.wrl` file stores the information for a virtual reality scene. During the initialization of the virtual reality animation object, any node with a `DEF` statement in the specified `.wrl` file has a node object created.

When working with nodes, consider the translation and rotation. Translation is a 1-by-3 matrix in the aerospace body coordinate system defined for the `VirtualRealityAnimation` object or another coordinate system. In the latter case, you can use the `CoordTransformFcn` function to move it into the defined aerospace body coordinate system. The defined aerospace body coordinate system is defined relative to the screen as *x*-left, *y*-in, *z*-down.

Rotation is a 1-by-3 matrix, in radians, that specifies the rotations about the right-hand *x-y-z* sequence of coordinate axes. The order of application of the rotation is *z-y-x* (*r-q-p*). This function uses the `CoordTransformFcn` to apply the translation and rotation from the input coordinate system to the defined aerospace body coordinate system. The function then moves the translation and rotation from the defined aerospace body coordinate system to the defined VRML *x-y-z* coordinates for the `VirtualRealityAnimation` object. The defined VRML coordinate system is defined relative to the screen as *x*-right, *y*-up, *z*-out.

## Constructor Summary

Constructor	Description
Node	Create node object for use with virtual reality animation.

## Method Summary

Method	Description
findstart-stoptimes	Return start and stop times for time series data.
move	Change node translation and rotation.
update	Change node position and orientation versus time data.

## Property Summary

Property	Description	Values
Name	Specify name of the node object.	Character vector
VRNode	Return the handle to the <code>vrnode</code> object associated with the node object.	MATLAB array
CoordtransformFcn	Specify a function that controls the coordinate transformation.	MATLAB array
TimeseriesSource	Specify time series source.	MATLAB array
Timeseries-Source Type	Specify the type of time series data stored in 'TimeseriesSource'. Five values are available. They are listed in the following table. The default value is 'Array6DoF'.	Character vector
TimeseriesReadFcn	Specify time series read function.	MATLAB array

The time series data, stored in the property 'TimeseriesSource', is interpreted according to the 'TimeseriesSource Type' property, which can be one of:

'Timeseries'      MATLAB time series data with six values per time:

lat lon alt phi theta psi

The values are resampled.

'StructureWithTime' Simulink struct with time (for example, Simulink root output logging 'Structure with time'):

- signals(1).values: lat lon alt
- signals(2).values: phi theta psi

Signals are linearly interpolated vs. time using `interp1`.

'Array6DoF' A double-precision array in  $n$  rows and 7 columns for 6-DoF data: time lat lon alt phi theta psi. If a double-precision array of 8 or more columns is in 'TimeseriesSource', the first 7 columns are used as 6-DoF data.

'Array3DoF' A double-precision array in  $n$  rows and 4 columns for 3-DoF data: time lat alt theta. If a double-precision array of 5 or more columns is in 'TimeseriesSource', the first 4 columns are used as 3-DoF data.

'Custom' Position and angle data is retrieved from 'TimeseriesSource' by the currently registered 'TimeseriesReadFcn'.

**Introduced in R2007b**

## Aero.Viewpoint

Create viewpoint object for use in virtual reality animation

### Syntax

```
h = Aero.Viewpoint
```

### Description

`h = Aero.Viewpoint` creates a viewpoint object for use with virtual reality animation.

### Constructor Summary

Constructor	Description
Viewpoint	Create node object for use with virtual reality animation.

### Property Summary

Property	Description	Values
Name	Specify name of the node object.	Character vector
Node	Specify node object that contains the viewpoint node.	MATLAB array

**Introduced in R2007b**

# Aero.VirtualRealityAnimation

Construct virtual reality animation object

## Syntax

```
h = Aero.VirtualRealityAnimation
```

## Description

`h = Aero.VirtualRealityAnimation` constructs a virtual reality animation object. The animation object is returned to `h`. The animation object has the following methods and properties.

## Constructor Summary

Constructor	Description
<code>VirtualReality-Animation</code>	Construct virtual reality animation object.

## Method Summary

Method	Description
<code>addNode</code>	Add existing node to current virtual reality world.
<code>addRoute</code>	Add VRML ROUTE statement to virtual reality animation.
<code>addViewpoint</code>	Add viewpoint for virtual reality animation.
<code>delete</code>	Destroy virtual reality animation object.
<code>initialize</code>	Create and populate virtual reality animation object.
<code>nodeInfo</code>	Create list of nodes associated with virtual reality animation object.

<b>Method</b>	<b>Description</b>
<code>play</code>	Animate virtual reality world for given position and angle in time series data.
<code>removeNode</code>	Remove node from virtual reality animation object.
<code>removeViewpoint</code>	Remove viewpoint node from virtual reality animation.
<code>saveas</code>	Save virtual reality world associated with virtual reality animation object.
<code>updateNodes</code>	Set new translation and rotation of moveable items in virtual reality animation.

## Notes on `Aero.VirtualRealityAnimation` Methods

`Aero.VirtualRealityAnimation` methods that change the current virtual reality world use a temporary `.wrl` file to manage those changes. These methods include:

- `addNode`
- `removeNode`
- `addViewpoint`
- `removeViewpoint`
- `addRoute`

Be aware of the following behavior:

- After the methods make the changes, they reinitialize the world, using the information stored in the temporary `.wrl` file.
- When you delete the virtual reality animation object, this action deletes the temporary file.
- Use the `saveas` method to save the temporary `.wrl` file.
- These methods do not affect user-created `.wrl` files.

## Property Summary

<b>Property</b>	<b>Description</b>	<b>Values</b>
Name	Specify name of the animation object.	Character vector

Property	Description	Values
VRWorld	Returns the vrworld object associated with the animation object.	MATLAB array
VRWorldFilename	Specify the .wrl file for the vrworld.	Character vector
VRWorldOldFilename	Specify the old .wrl files for the vrworld.	MATLAB array
VRWorldTempFilename	Specify the temporary .wrl file for the animation object.	Character vector
VRFigure	Returns the vrfigure object associated with the animation object.	MATLAB array
Nodes	Specify the nodes that the animation object contains.	MATLAB array
Viewpoints	Specify the viewpoints that the animation object contains.	MATLAB array
TimeScaling	Specify the time scaling, in seconds.	double
TStart	Specify the recording start time, in seconds.	double
TFinal	Specify end time, in seconds.	double
TCurrent	Specify current time, in seconds.	double
FramesPerSecond	Specify rate, in frames per second.	double
ShowSaveWarning	Specify save warning display setting.	double <ul style="list-style-type: none"> <li>• 0 — No warning is displayed.</li> <li>• Non-zero — Warning is displayed.</li> </ul>
VideoFileName	Specify video recording file name.	Character vector

Property	Description	Values
VideoCompression	Specify video recording compression file type. For more information on video compression, see VideoWriter.	<ul style="list-style-type: none"> <li>• 'Archival'</li> </ul> <p>Create Motion JPEG 2000 format file with lossless compression.</p> <ul style="list-style-type: none"> <li>• 'Motion JPEG AVI'</li> </ul> <p>Create compressed AVI format file using Motion JPEG codec.</p> <ul style="list-style-type: none"> <li>• 'Motion JPEG 2000'</li> </ul> <p>Create compressed Motion JPEG 2000 format file.</p> <ul style="list-style-type: none"> <li>• 'MPEG-4'</li> </ul> <p>Create compressed MPEG-4 format file with H.264 encoding (Windows 7 systems only).</p> <ul style="list-style-type: none"> <li>• 'Uncompressed AVI'</li> </ul> <p>Create uncompressed AVI format file with RGB24 video.</p> <p>Aero.VideoProfileTypeEnum</p> <p><b>Default:</b> 'Archival'</p>
VideoQuality	Specify video recording quality. For more information on video quality, see the Quality property of VideoWriter.	<p>Value between 0 and 100.</p> <p>double</p> <p><b>Default:</b> 75</p>



Property	Description	Values
VideoRecord	Enable video recording.	<ul style="list-style-type: none"> <li>• 'on'</li> </ul> <p>Enable video recording.</p> <ul style="list-style-type: none"> <li>• 'off'</li> </ul> <p>Disable video recording.</p> <ul style="list-style-type: none"> <li>• 'scheduled'</li> </ul> <p>Schedule video recording. Use this property with the <code>VideoTStart</code> and <code>VideoTFinal</code> properties.</p> <p><b>Default:</b> 'off'</p>
VideoTStart	Specify video recording start time for scheduled recording.	<p>Value between <code>TStart</code> and <code>TFinal</code>.</p> <p>double</p> <p><b>Default:</b> NaN, which uses the value of <code>TStart</code>.</p>
VideoTFinal	Specify video recording stop time for scheduled recording.	<p>Value between <code>TStart</code> and <code>TFinal</code>.</p> <p>double</p> <p><b>Default:</b> NaN, which uses the value of <code>TFinal</code>.</p>

## Examples

### Record Animation Object Simulation

Simulate and record flight data. Create an animation object.

```
h = Aero.Animation;
```

Control the frame display rate.

```
h.FramesPerSecond = 10;
```

Set the time-scaling (`TimeScaling`) property on the animation object to specify the data per second.

```
h.TimeScaling = 5;
```

The combination of `FramesPerSecond` and `TimeScaling` properties determines the time step of the simulation. These settings result in a time step of approximately 0.5 s.

Create and load a body for the animation object.

```
idx1 = h.createBody('pa24-250_orange.ac', 'Ac3d');
```

Load simulated flight trajectory data (`simdata`), located in `matlabroot\toolbox\ aero \astdemos`.

```
load simdata;
```

Set the time series data for the body.

```
h.Bodies{1}.TimeSeriesSource = simdata;
```

Create a figure object for the animation object.

```
h.show();
```



Set up recording properties.

```
h.VideoRecord = 'on';  
h.VideoQuality = 50;  
h.VideoCompression = 'Motion JPEG AVI'  
h.VideoFilename = 'astMotion_JPEG';
```

h =

```
Aero.Animation
```

Play the animation.

```
h.play();
```

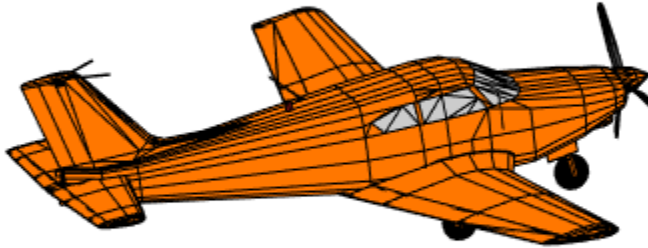

Verify that a file named `astMotion_JPEG.avi` was created in the current folder.

Disable recording to preserve the file.

```
h.VideoRecord = 'off';
```

### **Record Animation for Four Seconds**

Simulate flight data for four seconds. Create an animation object.

```
h = Aero.Animation;
```

Control the frame display rate.

```
h.FramesPerSecond = 10;
```

Configure the animation object to set the seconds of animation data per second time-scaling (`TimeScaling`) property.

```
h.TimeScaling = 5;
```

The combination of `FramesPerSecond` and `TimeScaling` properties determines the time step of the simulation (`TimeScaling/|FramesPerSecond|`). These settings result in a time step of approximately 0.5 s.

Create and load a body for the animation object.

```
idx1 = h.createBody('pa24-250_orange.ac', 'Ac3d');
```

Load simulated flight trajectory data (`simdata`), located in `matlabroot\toolbox\aero\astdemos`.

```
load simdata;
```

Set the time series data for the body.

```
h.Bodies{1}.TimeSeriesSource = simdata;
```

Create a figure object for the animation object.

```
h.show();
```



Set up recording properties.

```
h.VideoRecord='on';  
h.VideoQuality = 50;  
h.VideoCompression = 'Motion JPEG AVI';  
h.VideoFilename = 'astMotion_JPEG';
```

Play the animation from TFinal to TStart.

```
h.TStart = 1;  
h.TFinal = 5;  
h.play();
```

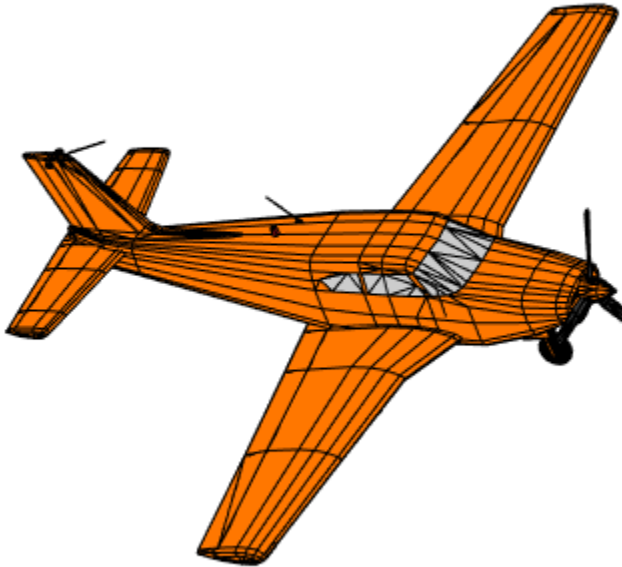

Verify that a file named `astMotion_JPEG.avi` was created in the current folder. When you rerun the recording, notice that the play time is shorter than that in the previous example when you record for the length of the simulation time.

Disable recording to preserve the file.

```
h.VideoRecord = 'off';
```

### **Schedule Three Second Recording of Simulation**

Schedule three second recording of animation object simulation. Create an animation object.

```
h = Aero.Animation;
```

Control the frame display rate.

```
h.FramesPerSecond = 10;
```

Configure the animation object to set the seconds of animation data per second time-scaling (`TimeScaling`) property.

```
h.TimeScaling = 5;
```

The combination of `FramesPerSecond` and `TimeScaling` properties determines the time step of the simulation (`TimeScaling/|FramesPerSecond|`). These settings result in a time step of approximately 0.5 s.

Create and load a body for the animation object.

```
idx1 = h.createBody('pa24-250_orange.ac', 'Ac3d');
```

Load simulated flight trajectory data (`simdata`), located in `matlabroot\toolbox\ aero \astdemos`.

```
load simdata;
```

Set the time series data for the body.

```
h.Bodies{1}.TimeSeriesSource = simdata;
```

Create a figure object for the animation object.

```
h.show();
```





Set up recording properties.

```
h.VideoQuality = 50;  
h.VideoCompression = 'Motion JPEG AVI';  
h.VideoFilename = 'astMotion_JPEG';
```

Set up simulation time from TFinal to TStart.

```
h.TStart = 1;  
h.TFinal = 5;
```

Set up to record between two and four seconds of the four second simulation.

```
h.VideoRecord='scheduled';  
h.VideoTStart = 2;
```

```
h.VideoTFinal = 4;
```

Play the animation.

```
h.play();
```

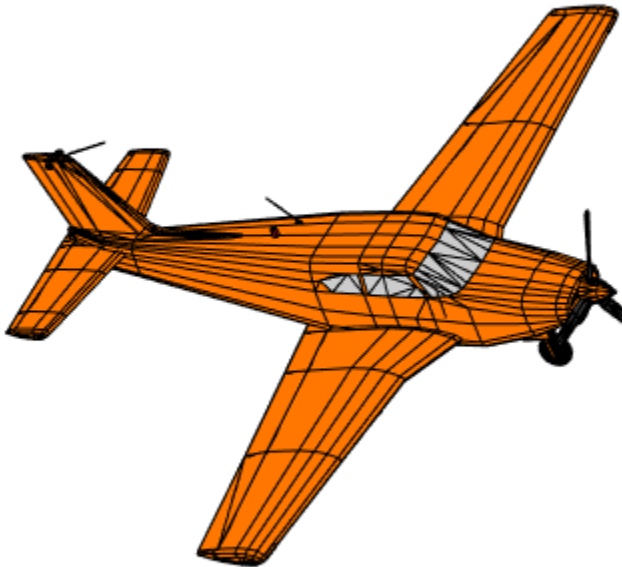

Verify that a file named `astMotion_JPEG.avi` was created in the current folder. When you rerun the recording, notice that the play time is shorter than that in the previous example when you record for the length of the simulation time.

Disable recording to preserve the file.

```
h.VideoRecord = 'off';
```

**Introduced in R2007b**

# airspeed

Airspeed from velocity

## Syntax

```
airspeed = airspeed(velocities)
```

## Description

`airspeed = airspeed(velocities)` computes  $m$  airspeeds, `airspeed`, from an  $m$ -by-3 array of velocities, `velocities`.

## Examples

Determine the airspeed for velocity one array:

```
as = airspeed([84.3905 33.7562 10.1269])
```

```
as =
```

```
91.4538
```

Determine the airspeed for velocity for multiple arrays:

```
as = airspeed([50 20 6; 5 0.5 2])
```

```
as =
```

```
54.1849
```

```
5.4083
```

## See Also

[alphabet](#) | [correctairspeed](#) | [dpressure](#) | [machnumber](#)

Introduced in R2006b

# alphabet

Incidence and sideslip angles

## Syntax

```
[incidence sideslip] = alphabet(velocities)
```

## Description

[*incidence sideslip*] = alphabet(*velocities*) computes  $m$  incidence and sideslip angles, *incidence* and *sideslip*, between the velocity vector and the body. *velocities* is an  $m$ -by-3 array of velocities in body axes. *incidence* and *sideslip* are in radians.

## Examples

Determine the incidence and sideslip angles for velocity for one array:

```
[alpha beta] = alphabet([84.3905 33.7562 10.1269])
```

```
alpha =
```

```
0.1194
```

```
beta =
```

```
0.3780
```

Determine the incidence and sideslip angles for velocity for two arrays:

```
[alpha beta] = alphabet([50 20 6; 5 0.5 2])
```

```
alpha =
```

```
0.1194  
0.3805
```

beta =

0.3780

0.0926

## See Also

airspeed | machnumber

**Introduced in R2006b**

# angle2dcm

Convert rotation angles to direction cosine matrix

## Syntax

```
dcm = angle2dcm(rotationAng1, rotationAng2, rotationAng3)
dcm = angle2dcm(rotationAng1, rotationAng2, rotationAng3,
rotationSequence)
```

## Description

`dcm = angle2dcm(rotationAng1, rotationAng2, rotationAng3)` calculates the direction cosine matrix given three sets of rotation angles.

`dcm = angle2dcm(rotationAng1, rotationAng2, rotationAng3, rotationSequence)` calculates the direction cosine matrix using a rotation sequence.

## Input Arguments

### **rotationAng1**

*m*-by-1 array of first rotation angles, in radians.

### **rotationAng2**

*m*-by-1 array of second rotation angles, in radians.

### **rotationAng3**

*m*-by-1 array of third rotation angles, in radians.

### **rotationSequence**

Rotation sequence. For example, the default 'ZYX' represents a sequence where *rotationAng1* is *z*-axis rotation, *rotationAng2* is *y*-axis rotation, and *rotationAng3* is *x*-axis rotation.

```
'ZYX'
'YZY'
'ZXY'
'ZXZ'
'YXZ'
'YXY'
'YZX'
'YZY'
'XYZ'
'XZY'
'XYX'
'XZX'
'ZYX' (default)
```

## Output Arguments

### dcm

3-by-3-by- $m$  matrix containing  $m$  direction cosine matrices.

## Examples

Determine the direction cosine matrix from rotation angles:

```
yaw = 0.7854;
pitch = 0.1;
roll = 0;
dcm = angle2dcm( yaw, pitch, roll )
```

dcm =

```
    0.7036    0.7036   -0.0998
   -0.7071    0.7071    0
    0.0706    0.0706    0.9950
```

Determine the direction cosine matrix from rotation angles and rotation sequence:

```
yaw = [0.7854 0.5];
pitch = [0.1 0.3];
roll = [0 0.1];
```

```
dcm = angle2dcm( pitch, roll, yaw, 'YXZ' )
```

```
dcm(:, :, 1) =
```

```
    0.7036    0.7071   -0.0706  
   -0.7036    0.7071    0.0706  
    0.0998         0    0.9950
```

```
dcm(:, :, 2) =
```

```
    0.8525    0.4770   -0.2136  
   -0.4321    0.8732    0.2254  
    0.2940   -0.0998    0.9506
```

### See Also

[angle2quat](#) | [dcm2angle](#) | [dcm2quat](#) | [quat2dcm](#) | [quat2angle](#)

**Introduced in R2006b**



# angle2quat

Convert rotation angles to quaternion

## Syntax

```
quaternion = angle2quat(rotationAng1,rotationAng2,rotationAng3)  
quaternion =  
angle2quat(rotationAng1,rotationAng2,rotationAng3,rotationSequence)
```

## Description

*quaternion* = angle2quat(*rotationAng1*,*rotationAng2*,*rotationAng3*)  
calculates the quaternion for three rotation angles.

*quaternion* =  
angle2quat(*rotationAng1*,*rotationAng2*,*rotationAng3*,*rotationSequence*)  
calculates the quaternion using a rotation sequence.

## Input Arguments

### **rotationAng1**

*m*-by-1 array of first rotation angles, in radians.

### **rotationAng2**

*m*-by-1 array of second rotation angles, in radians.

### **rotationAng3**

*m*-by-1 array of third rotation angles, in radians.

### **rotationSequence**

Rotation sequence. For example, the default 'ZYX' represents a sequence where *rotationAng1* is *z*-axis rotation, *rotationAng2* is *y*-axis rotation, and *rotationAng3* is *x*-axis rotation.

```
'ZYX'  
'YZY'  
'ZXY'  
'ZXZ'  
'YXZ'  
'YXY'  
'YZX'  
'YZY'  
'XYZ'  
'XZY'  
'YXY'  
'XZX'  
'ZYX' (default)
```

## Output Arguments

### **quaternion**

$m$ -by-4 matrix containing  $m$  quaternions. *quaternion* has its scalar number as the first column.

## Examples

Determine the quaternion from rotation angles:

```
yaw = 0.7854;  
pitch = 0.1;  
roll = 0;  
q = angle2quat(yaw, pitch, roll)  
q =  
    0.9227    -0.0191    0.0462    0.3822
```

Determine the quaternion from rotation angles and rotation sequence:

```
yaw = [0.7854 0.5];  
pitch = [0.1 0.3];  
roll = [0 0.1];  
q = angle2quat(pitch, roll, yaw, 'YXZ')  
q =
```

0.9227	0.0191	0.0462	0.3822
0.9587	0.0848	0.1324	0.2371

## See Also

[angle2dcm](#) | [dcm2angle](#) | [dcm2quat](#) | [quat2angle](#) | [quat2dcm](#)

**Introduced in R2007b**

## angle2rod

Convert rotation angles to Euler-Rodrigues vector

### Syntax

```
rod=angle2rod(R1,R2,R3)
rod=angle2rod(R1,R2,R3,S)
```

### Description

`rod=angle2rod(R1,R2,R3)` function converts the rotation described by the three rotation angles, *R1*, *R2*, and *R3*, into an *M*-by-3 Euler-Rodrigues matrix, `rod`.

`rod=angle2rod(R1,R2,R3,S)` function converts the rotation described by the three rotation angles and a rotation sequence, *S*, into an *M*-by-3 Euler-Rodrigues array, `rod`, that contains the *M* Rodrigues vector.

### Examples

#### Determine the Rodrigues Vector from One Rotation Angle

Determine the Rodrigues vector from rotation angles.

```
yaw = 0.7854;
pitch = 0.1;
roll = 0;
r = angle2rod(yaw,pitch,roll)

r =

    -0.0207    0.0500    0.4142
```

#### Determine Rodrigues Vectors from Multiple Rotation Angles

Determine the Rodrigues vectors from multiple rotation angles.

```
yaw = [0.7854 0.5];
```

```
pitch = [0.1 0.3];
roll = [0 0.1];
r = angle2rod(pitch,roll,yaw,'YXZ')

r =

    0.0207    0.0500    0.4142
    0.0885    0.1381    0.2473
```

## Input Arguments

### R1 — First rotation angle

*M*-by-1 array

First rotation angle, in radians, from which to determine Euler-Rodrigues vector. Values must be real.

Data Types: double | single

### R2 — Second rotation angle

*M*-by-1 array

Second rotation angle, in radians, from which to determine Euler-Rodrigues vector. Values must be real.

Data Types: double | single

### R3 — Third rotation angle

*M*-by-1 array

Third rotation angle, in radians, from which to determine Euler-Rodrigues vector. Values must be real.

Data Types: double | single

### S — Rotation sequence

ZYX (default) | ZYZ | ZXY | ZXZ | YXZ | YXY | YZX | YZY | XYZ | XYX | XZY | XZX

Rotation sequence. For the default rotation sequence, ZYX, the rotation angle order is:

- R1 — *z*-axis rotation
- R2 — *y*-axis rotation

- R3 —  $x$ -axis rotation

Data Types: char | string

## Output Arguments

### **rod** — Euler-Rodrigues vector

3-element vector

Euler-Rodrigues vector determined from rotation angles.

## Algorithms

An Euler-Rodrigues vector  $\vec{b}$  represents a rotation by integrating a direction cosine of a rotation axis with the tangent of half the rotation angle as follows:

$$\vec{b} = [b_x \quad b_y \quad b_z]$$

where:

$$b_x = \tan\left(\frac{1}{2}\theta\right) s_x,$$

$$b_y = \tan\left(\frac{1}{2}\theta\right) s_y,$$

$$b_z = \tan\left(\frac{1}{2}\theta\right) s_z$$

are the Rodrigues parameters. Vector  $\vec{s}$  represents a unit vector around which the rotation is performed. Due to the tangent, the rotation vector is indeterminate when the rotation angle equals  $\pm\pi$  radians or  $\pm 180$  deg. Values can be negative or positive.

## References

- [1] Dai, J.S. "Euler-Rodrigues formula variations, quaternion conjugation and intrinsic connections." *Mechanism and Machine Theory*, 92, 144-152. Elsevier, 2015.

## See Also

### See Also

[dcm2rod](#) | [quat2rod](#) | [rod2angle](#) | [rod2dcm](#) | [rod2quat](#)

**Introduced in R2017a**

## atmoscoesa

Use 1976 COESA model

### Syntax

$[T, a, P, Rho] = \text{atmoscoesa}(\text{height}, \text{action})$

### Description

Committee on Extension to the Standard Atmosphere has the acronym COESA.  $[T, a, P, Rho] = \text{atmoscoesa}(\text{height}, \text{action})$  implements the mathematical representation of the 1976 COESA United States standard lower atmospheric values. These values are absolute temperature, pressure, density, and speed of sound for the input geopotential altitude.

Below the geopotential altitude of 0 m (0 feet) and above the geopotential altitude of 84,852 m (approximately 278,386 feet), the function extrapolates values. It extrapolates temperature values linearly and pressure values logarithmically.

### Input Arguments

#### **height**

Array of  $m$ -by-1 geopotential heights, in meters.

#### **action**

Action for out-of-range input. Specify one:

'Error'

'Warning' (default)

'None'



## Output Arguments

### **T**

Array of  $m$ -by-1 temperatures, in kelvin.

### **a**

Array of  $m$ -by-1 speeds of sound, in meters per second. The function calculates speed of sound using a perfect gas relationship.

### **P**

Array of  $m$ -by-1 pressures, in pascal.

### **Rho**

Array of  $m$ -by-1 densities, in kilograms per meter cubed. The function calculates density using a perfect gas relationship.

## Examples

Calculate the COESA model at 1000 m with warnings for out-of-range inputs:

```
[T, a, P, rho] = atmoscoesa(1000)
```

```
T =
```

```
281.6500
```

```
a =
```

```
336.4341
```

```
P =
```

```
8.9875e+004
```

```
rho =
```

```
1.1116
```

Calculate the COESA model at 1000, 11,000, and 20,000 m with errors for out-of-range inputs:

```
[T, a, P, rho] = atmoscoesa([1000 11000 20000], 'Error')
```

T =

```
281.6500 216.6500 216.6500
```

a =

```
336.4341 295.0696 295.0696
```

P =

```
1.0e+004 *  
8.9875 2.2632 0.5475
```

rho =

```
1.1116 0.3639 0.0880
```

## References

*U.S. Standard Atmosphere*, 1976, U.S. Government Printing Office, Washington, D.C.

## See Also

[atmoscira](#) | [atmosisa](#) | [atmoslapse](#) | [atmosnonstd](#) | [atmospalt](#)

**Introduced in R2006b**

## atmoscira

Use COSPAR International Reference Atmosphere 1986 model

### Syntax

```
[T altitude zonalWind] = atmoscira(latitude, ctype, coord, mtype, month, action)
```

### Description

[NOTE: THIS IS A TEST]

[*T altitude zonalWind*] = *atmoscira(latitude, ctype, coord, mtype, month, action)* implements the mathematical representation of the Committee on Space Research (COSPAR) International Reference Atmosphere (CIRA) from 1986 model. The CIRA 1986 model provides a mean climatology. The mean climatology consists of temperature, zonal wind, and geopotential height or pressure. It encompasses nearly pole-to-pole coverage (80 degrees S to 80 degrees N) for 0 km to 120 km. This provision also encompasses the troposphere, middle atmosphere, and lower thermosphere. Use this mathematical representation as a function of pressure or geopotential height.

This function uses a corrected version of the CIRA data files provided by J. Barnett in July 1990 in ASCII format.

This function has the limitations of the CIRA 1986 model and limits the values for the CIRA 1986 model.

The CIRA 1986 model limits values to the regions of 80 degrees S to 80 degrees N on Earth. It also limits geopotential heights from 0 km to 120 km. In each monthly mean data set, the model omits values at 80 degrees S for 101,300 pascal or 0 m. It omits these values because these levels are within the Antarctic land mass. For zonal mean pressure in constant altitude coordinates, pressure data is not available below 20 km. Therefore, this value is the bottom level of the CIRA climatology.

## Input Arguments

### **latitude**

Array of  $m$  geopotential heights, in meters.

### **ctype**

Representation of coordinate type. Specify:

'Pressure'	Pressure in pascal
'GPHeight'	Geopotential height in meters

### **coord**

Depending on the value of **ctype**, this argument specifies one of the following arrays:

$m$	Pressures in pascal
$m$	Geopotential height in meters

### **mtype**

Mean value type:

'Monthly' (default)	Monthly values.
'Annual'	Annual values. Valid when <b>ctype</b> has a value of 'Pressure'.

### **month**

Scalar value that selects the month in which the model takes the mean values. This argument applies only when **mtype** has a value of 'Monthly'.

1 (default)	January
2	February
3	March
4	April
5	May

6	June
7	July
8	August
9	September
10	October
11	November
12	December

**action**

Action for out-of-range input. Specify one:

'Error'

'Warning' (default)

'None'

## Output Arguments

**T**

Array of temperatures:

If  $m$  is 'Monthly'

Array of  $m$  temperatures, in kelvin

If  $mtype$  is 'Annual'

Array of  $m$ -by-7 values:

- Annual mean temperature in kelvin
- Annual temperature cycle amplitude in kelvin
- Annual temperature cycle phase in month of maximum
- Semiannual temperature cycle amplitude in kelvin
- Semiannual temperature cycle phase in month of maximum
- Terannual temperature cycle amplitude in kelvin
- Terannual temperature cycle phase in month of maximum



## Examples

Using the CIRA 1986 model at 45 degrees latitude and 101,300 pascal for January with out-of-range actions generating warnings, calculate the mean monthly values. Calculate values for temperature ( $T$ ), geopotential height ( $alt$ ), and zonal wind ( $zwind$ ).

```
[T alt zwind] = atmoscira( 45, 'Pressure', 101300 )
T =
    280.6000
alt =
    -18
zwind =
    3.3000
```

Using the CIRA 1986 model at 45 degrees latitude and 20,000 m for October with out-of-range actions generating warnings, calculate the mean monthly values. Calculate values for temperature ( $T$ ), pressure ( $pres$ ), and zonal wind ( $zwind$ ).

```
[T pres zwind] = atmoscira( 45, 'GPHeight', 20000, 'Monthly', 10)
T =
    215.8500
pres =
    5.5227e+003
zwind =
    9.5000
```

Use the CIRA 1986 model at 45 and -30 degrees latitude and 20,000 m for October with out-of-range actions generating errors. Calculate values for temperature ( $T$ ), pressure ( $pres$ ), and zonal wind ( $zwind$ ).

```
[T pres zwind] = atmoscira( [45 -30], 'GPHeight', 20000, 10, 'error')
T =
    215.8500  213.9000
pres =
    1.0e+003 *
    5.5227    5.6550
zwind =
    9.5000    4.3000
```

For September, with out-of-range actions generating warnings, use the CIRA 1986 model at 45 degrees latitude and -30 degrees latitude. Also use the model at 2000 pascal and 101,300 pascal. Calculate mean monthly values for temperature ( $T$ ), geopotential height ( $alt$ ), and zonal wind ( $zwind$ ).

```
[T alt zwind] = atmoscira( [45 -30], 'Pressure', [2000 101300], 9)
T =
    223.5395  290.9000
alt =
```

```
1.0e+004 *
2.6692    0.0058
zwind =
0.6300   -1.1000
```

Using the CIRA 1986 model at 45 degrees latitude and 2000 pascal with out-of-range actions generating warnings, calculate annual values. Calculate values for temperature (*T*), geopotential height (*alt*), and zonal wind (*zwind*).

```
[T alt zwind] = atmoscira( 45, 'Pressure', 2000, 'Annual' )
T =
221.9596    5.0998    6.5300    1.9499    1.3000    1.0499    1.3000
alt =
1.0e+004 *
2.6465    0.0417    0.0007    0.0087    0.0001    0.0015    0.0002
zwind =
4.6099    14.7496    0.6000    1.6499    4.6000    0.5300    1.4000
```

## References

Fleming, E. L., Chandra, S., Shoerberl, M. R., Barnett, J. J., *Monthly Mean Global Climatology of Temperature, Wind, Geopotential Height and Pressure for 0-120 km*, NASA TM100697, February 1988

<http://ccmc.gsfc.nasa.gov/modelweb/atmos/cospar1.html>

## See Also

atmoscoesa | atmosisa | atmoslapse | atmosnonstd | atmosnr1msise00 | atmospalt

**Introduced in R2007b**



# atmoshwm

Implement horizontal wind model

## Syntax

```
wind = atmoshwm(latitude,longitude,altitude)
```

```
wind = atmoshwm(latitude,longitude,altitude,Name,Value)
```

## Description

`wind = atmoshwm(latitude,longitude,altitude)` implements the U.S. Naval Research Laboratory Horizontal Wind Model (HWM™) routine to calculate the meridional and zonal components of the wind for one or more sets of geophysical data: `latitude`, `longitude`, and `altitude`.

`wind = atmoshwm(latitude,longitude,altitude,Name,Value)` uses additional options specified by one or more `Name,Value` pair arguments.

## Examples

### Calculate the Total Horizontal Wind Model

Calculate the total horizontal wind model for a latitude of 45 degrees south, longitude of 85 degrees west, and altitude of 25,000 m above mean sea level (msl). The date is the 150th day of the year, at 11 am UTC, using an Ap index of 80. The horizontal model version is 14.

```
w = atmoshwm(-45,-85,25000,'day',150,'seconds',39600,'apindex',80,'model','total','version','14')
```

```
w =
```

```
    3.2874    25.8735
```

### Calculate the Quiet Horizontal Wind Model

Calculate the quiet horizontal wind model for a latitude of 50 degrees north, two altitudes of 100,000 m and 150,000 m above msl, and a longitude of 20 degrees west. The date is midnight UTC of January 30. The default horizontal model version is 14.

```
w = atmoswm([50;50],[-20;-20],[100000;150000],'day',[30;30])
```

```
w =
```

```
-42.9350 -40.3693  
29.1106 0.6253
```

## Input Arguments

### **latitude** — Geodetic latitude

scalar |  $M$ -by-1 array

Geodetic latitudes, in degrees, specified as a scalar or  $M$ -by-1 array, where  $M$  is one or more sets of geophysical data.

Example: -45

Data Types: double

### **longitude** — Geodetic longitude

scalar |  $M$ -by-1 array

Geodetic longitudes, in degrees, specified as a scalar or  $M$ -by-1 array, where  $M$  is one or more sets of geophysical data.

Example: -85

Data Types: double

### **altitude** — Geopotential height

scalar |  $M$ -by-1 array

Geopotential heights, in meters, within the range of 0 to 500 km, specified as a scalar or  $M$ -by-1 array.  $M$  is one or more sets of geophysical data.

Example: 25000

Data Types: double

## Name-Value Pair Arguments

Specify optional comma-separated pairs of `Name`, `Value` arguments. `Name` is the argument name and `Value` is the corresponding value. `Name` must appear inside single

quotes (' '). You can specify several name and value pair arguments in any order as `Name1,Value1,...,NameN,ValueN`.

Example: `'apindex',80,'model','total'` specifies that the total horizontal wind model be calculated for an Ap index of 80.

### 'apindex' — Ap index

*M*-by-1 array of zeroes (default) | scalar | *M*-by-1 array

Ap index for the Universal Coordinated Time (UTC) at which `atmoshwm` evaluates the model, specified as an *M*-by-1 array of zeroes, a scalar, or an *M*-by-1 array. *M* is one or more sets of geophysical data. Select the index from the NOAA National Geophysical Data Center, which contains three-hour interval geomagnetic disturbance index values. If the Ap index value is greater than zero, the model evaluation accounts for magnetic effects.

Specify the Ap index as a value from 0 through 400. Specify an Ap index value for only the disturbance or total wind model type.

Data Types: double

### 'day' — Day of year

*M*-by-1 array of ones (default) | scalar | *M*-by-1 array

Day of year in UTC. Specify the day as a value from 1 through 366 (for a leap year), specified as an *M*-by-1 array of zeroes, a scalar, or an *M*-by-1 array. *M* is one or more sets of geophysical data.

Data Types: double

### 'seconds' — Elapsed seconds

*M*-by-1 array of zeroes (default) | scalar | *M*-by-1 array

Elapsed seconds since midnight for the selected day, in UTC, specified as specified as an *M*-by-1 array of zeroes, a scalar, or an *M*-by-1 array. *M* is one or more sets of geophysical data.

Specify the seconds as a value from 0 through 86,400.

Data Types: double

### 'model' — Horizontal wind model type

'quiet' (default) | 'disturbance' | 'total'

Horizontal wind model type for which to calculate the wind components. This setting applies to all the sets of geophysical data in *M*.

- 'quiet'

Calculates the horizontal wind model without the magnetic disturbances. Quiet model types do not account for Ap index values. For this model type, do not specify an Ap index value when using this model type.

- 'disturbance'

Calculates the effect of only magnetic disturbances in the wind. For this model type, specify Ap index values greater than or equal to zero.

- 'total'

Calculates the combined effect of the quiet and magnetic disturbances. for this model type, specify Ap index values greater than or equal to zero.

Data Types: double

**'action' — Function behavior**

'Error' (default) | 'None' | 'Warning'

Function behavior when inputs are out of range, specified as one of these values. This type applies to all the sets of geophysical data in *M*.

Value	Description
'None'	No action.
'Warning'	Warning in the MATLAB Command Window, model simulation continues.
'Error'	MATLAB returns an exception, model simulation stops.

Data Types: double

**'version' — Horizontal wind model version**

'14' (default) | '07'

Implements specified horizontal wind model type.

- '14'

Horizontal Wind Model 14.

- '07'

Horizontal Wind Model 07.

Data Types: double

## Output Arguments

**wind** — Meridional and zonal wind components

*M*-by-2 array

Meridional and zonal wind components of the horizontal wind model, returned as an *M*-by-2 array, in m/s.

## See Also

### See Also

[atmoscira](#) | [atmoscoesa](#) | [atmosnr1msise00](#)

### External Websites

[NOAA National Geophysical Data Center](#)

**Introduced in R2016b**

# atmosisa

Use International Standard Atmosphere model

## Syntax

```
[T, a, P, rho] = atmosisa(height)
```

## Description

`[T, a, P, rho] = atmosisa(height)` implements the mathematical representation of the International Standard Atmosphere values for ambient temperature, pressure, density, and speed of sound for the input geopotential altitude.

This function assumes that below the geopotential altitude of 0 km and above the geopotential altitude of the tropopause (at 20 km), temperature and pressure values are held constant.

## Input Arguments

### height

Array of  $m$ -by-1 geopotential heights, in meters.

## Output Arguments

### T

Array of  $m$  temperatures, in kelvin.

### a

Array of  $m$  speeds of sound, in meters per second. The function calculates speed of sound using a perfect gas relationship.

**rho**

Array of  $m$  densities, in kilograms per meter cubed. The function calculates density using a perfect gas relationship.

**P**

Array of  $m$  pressures, in pascal.

**Examples**

Calculate the International Standard Atmosphere at 1000 m:

```
[T, a, P, rho] = atmosisa(1000)
```

T =

```
281.6500
```

a =

```
336.4341
```

P =

```
8.9875e+004
```

rho =

```
1.1116
```

Calculate the International Standard Atmosphere at 1000, 11,000, and 20,000 m:

```
[T, a, P, rho] = atmosisa([1000 11000 20000])
```

T =

```
281.6500 216.6500 216.6500
```

a =

```
336.4341 295.0696 295.0696
```

P =

1.0e+004 \*

8.9875    2.2632    0.5475

rho =

1.1116    0.3639    0.0880

## References

*U.S. Standard Atmosphere*, 1976, U.S. Government Printing Office, Washington, D.C.

## See Also

[atmoscira](#) | [atmoscoesa](#) | [atmoslapse](#) | [atmosnonstd](#) | [atmospalt](#)

**Introduced in R2006b**



# atmoslapse

Use Lapse Rate Atmosphere model

## Syntax

```
[T, a, P, rho] = atmoslapse(height, g, heatRatio,
characteristicGasConstant, lapseRate, heightTroposphere,
heightTropopause, density0, pressure0, temperature0)
[T, a, P, rho] = atmoslapse(height, g, heatRatio,
characteristicGasConstant, lapseRate, heightTroposphere,
heightTropopause, density0, pressure0, temperature0, height0)
```

## Description

`[T, a, P, rho] = atmoslapse(height, g, heatRatio, characteristicGasConstant, lapseRate, heightTroposphere, heightTropopause, density0, pressure0, temperature0)` implements the mathematical representation of the lapse rate atmospheric equations for ambient temperature, pressure, density, and speed of sound for the input geopotential altitude. To customize this atmospheric model, specify the atmospheric properties in the function input.

The function holds temperature and pressure values below the geopotential altitude of 0 km and above the geopotential altitude of the tropopause. The function calculates the density and speed of sound using a perfect gas relationship.

`[T, a, P, rho] = atmoslapse(height, g, heatRatio, characteristicGasConstant, lapseRate, heightTroposphere, heightTropopause, density0, pressure0, temperature0, height0)` indicates that the values for ambient temperature, pressure, density, and speed of sound are for below mean sea level geopotential altitudes.

The function holds temperature and pressure values below the geopotential altitude of `height0` and above the geopotential altitude of the tropopause. The function calculates the density and speed of sound using a perfect gas relationship.

## Input Arguments

### **height**

Array of  $m$ -by-1 geopotential heights, in meters.

### **g**

Scalar of acceleration due to gravity, in meters per second squared.

### **heatRatio**

Scalar of specific heat ratio.

### **characteristicGasConstant**

Scalar of characteristic gas constant, in joule per kilogram-kelvin.

### **lapseRate**

Scalar of lapse rate, in kelvin per meter.

### **heightTroposphere**

Scalar of height of troposphere, in meters.

### **heightTropopause**

Scalar of height of tropopause, in meters.

### **density0**

Scalar of air density at mean sea level, in kilograms per meter cubed.

### **pressure0**

Scalar of static pressure at mean sea level, in pascal.

### **temperature0**

Scalar of absolute temperature at mean sea level, in kelvin.

**height0**

Scalar of minimum sea level altitude, in meters.

## Output Arguments

**T**

Array of  $m$ -by-1 temperatures, in kelvin.

**a**

Array of  $m$ -by-1 speeds of sound, in meters per second. The function calculates speed of sound using a perfect gas relationship.

**P**

Array of  $m$ -by-1 pressures, in pascal.

**rho**

Array of  $m$ -by-1 densities, in kilograms per meter cubed. The function calculates density using a perfect gas relationship.

## Examples

Calculate the atmosphere at 1000 m with the International Standard Atmosphere input values:

```
[T, a, P, rho] = atmoslapse(1000, 9.80665, 1.4, 287.0531, 0.0065, ...  
    11000, 20000, 1.225, 101325, 288.15 )
```

T =

```
    281.6500
```

a =

```
    336.4341
```

P =

```
    8.9875e+004
```

rho =

1.1116

## **References**

*U.S. Standard Atmosphere*, 1976, U.S. Government Printing Office, Washington, D.C.

## **See Also**

atmoscira | atmoscoesa | atmosisa | atmosnonstd | atmospalt

**Introduced in R2006b**

# atmosnonstd

Use climatic data from MIL-STD-210 or MIL-HDBK-310

## Syntax

```
[T, a, P, rho] = atmosnonstd(height, atmosphericType,  
extremeParameter, frequency, extremeAltitude, action, specification)
```

## Description

[T, a, P, rho] = atmosnonstd(*height*, *atmosphericType*, *extremeParameter*, *frequency*, *extremeAltitude*, *action*, *specification*) implements a portion of the climatic data of the MIL-STD-210C or MIL-HDBK-310 worldwide air environment to 80 km geometric (or approximately 262,000 feet geometric). This implementation provides absolute temperature, pressure, density, and speed of sound for the input geopotential altitude.

This function holds all values below the geometric altitude of 0 m (0 feet) and above the geometric altitude of 80,000 m (approximately 262,000 feet). The envelope atmospheric model has exceptions where values are held below the geometric altitude of 1 km (approximately 3281 feet). It also has exceptions above the geometric altitude of 30,000 m (approximately 98,425 feet). These exceptions are due to lack of data in MIL-STD-210 or MIL-HDBK-310 for these conditions.

In general, this function interpolates temperature values linearly and density values logarithmically. It calculates pressure and speed of sound using a perfect gas relationship. The envelope atmospheric model has exceptions where the extreme value is the only value provided as an output. In these cases, the function interpolates pressure logarithmically. These envelope atmospheric model exceptions apply to all cases of high and low pressure, high and low temperature, and high and low density. These exceptions exclude the extreme values and 1% frequency of occurrence. These exceptions are due to lack of data in MIL-STD-210 or MIL-HDBK-310 for these conditions.

A limitation is that MIL-STD-210 and MIL-HDBK-310 exclude from consideration climatic data for the region south of 60 degrees S latitude.

This function uses the metric version of data from the MIL-STD-210 or MIL-HDBK-310 specifications. A limitation is some inconsistent data between the metric and English

data. Locations where these inconsistencies occur are within the envelope data for low density, low temperature, high temperature, low pressure, and high pressure. The most noticeable differences occur in the following values:

- For low density envelope data with 5% frequency, the density values in metric units are inconsistent at 4 km and 18 km. In addition, the density values in English units are inconsistent at 14 km.
- For low density envelope data with 10% frequency, the density values in metric units are inconsistent at 18 km. In addition, the density values in English units are inconsistent at 14 km.
- For low density envelope data with 20% frequency, the density values in English units are inconsistent at 14 km.
- For high-pressure envelope data with 10% frequency, the pressure values at 8 km are inconsistent.

## Input Arguments

### **height**

Array of  $m$ -by-1 geopotential heights, in meters.

### **atmosphericType**

Representation of 'Profile' or 'Envelope' for the atmospheric data:

'Profile'	Is the realistic atmospheric profiles associated with extremes at specified altitudes. Use 'Profile' for simulation of vehicles vertically traversing the atmosphere, or when you need the total influence of the atmosphere.
'Envelope'	Uses extreme atmospheric values at each altitude. Use 'Envelope' for vehicles traversing the atmosphere horizontally, without much change in altitude.

### **extremeParameter**

Atmospheric parameter that is the extreme value. Atmospheric parameters that you can specify are:

'High temperature'  
'Low temperature'

'High density'  
 'Low density'  
 'High pressure', available only if *atmosphericType* is 'Envelope'  
 'Low pressure', available only if *atmosphericType* is 'Envelope'

### **frequency**

Percent of time that extreme values would occur. When using *atmosphericType* of 'Envelope' and *frequency* of '5%', '10%', and '20%', only the *extreme\** parameter that you specify (temperature, density, or pressure) has a valid output. All other parameter outputs are zero.

'Extreme values', available only if *atmosphericType* is 'Envelope'  
 '1%'  
 '5%', available only if *atmosphericType* is 'Envelope'  
 '10%'  
 '20%', available only if *atmosphericType* is 'Envelope'

### **extremeAltitude**

Scalar value, in kilometers, selecting geometric altitude at which the extreme values occur. *extremeAltitude* applies only when *atmosphericType* is 'Profile'.

5	16404 ft
10	32808 ft
20	65617 ft
30	98425 ft
40	131234 ft

### **action**

Action for out-of-range input:

'Error'  
 'Warning' (default)  
 'None'

### **specification**

Atmosphere model:

'210c'                    MIL-STD-210C

'310' MIL-HDBK-310 (default)

## Output Arguments

### **T**

Array of  $m$ -by-1 temperatures, in kelvin. This function interpolates temperature values linearly.

### **a**

Array of  $m$ -by-1 speeds of sound, in meters per second. This function calculates speed of sound using a perfect gas relationship.

### **P**

Array of  $m$ -by-1 pressures, in pascal. This function calculates pressure using a perfect gas relationship.

### **rho**

Array of  $m$ -by-1 densities, in kilograms per meter cubed. This function interpolates density values logarithmically.

## Examples

Calculate the nonstandard atmosphere profile. Use high density occurring 1% of the time at 5 km from MIL-HDBK-310 at 1000 m with warnings for out-of-range inputs:

```
[T, a, P, rho] = atmosnonstd( 1000, 'Profile', 'High density', '1%', 5 )
```

```
T =
```

```
248.1455
```

```
a =
```

```
315.7900
```

```
P =
```

```
8.9893e+004
```



```
rho =
    1.2620
```

Calculate the nonstandard atmosphere envelope with high pressure. Assume that high pressure occurs 20% of the time from MIL-STD-210C at 1000, 11,000, and 20,000 m with errors for out-of-range inputs:

```
[T, a, P, rho] = atmosnonstd([1000 11000 20000], 'Envelope', ...
                             'High pressure', '20%', 'Error', '210c' )
```

```
T =
    0     0     0

a =
    0     0     0

P =
    1.0e+004 *
    9.1598    2.5309    0.6129

rho =
    0     0     0
```

## References

*Global Climatic Data for Developing Military Products (MIL-STD-210C)*, 9 January 1987, Department of Defense, Washington, D.C.

*Global Climatic Data for Developing Military Products (MIL-HDBK-310)*, 23 June 1997, Department of Defense, Washington, D.C.

## See Also

atmoscira | atmoscoesa | atmosisa | atmoslapse | atmospalt

**Introduced in R2006b**

## atmosnrlmsise00

Implement mathematical representation of 2001 United States Naval Research Laboratory Mass Spectrometer and Incoherent Scatter Radar Exosphere

### Syntax

`[T rho] = atmosnrlmsise00(altitude, latitude, longitude, year, dayOfYear, UTseconds)`

`[T rho] = atmosnrlmsise00(altitude, latitude, longitude, year, dayOfYear, UTseconds, localApparentSolarTime)`

`[T rho] = atmosnrlmsise00(altitude, latitude, longitude, year, dayOfYear, UTseconds, f107Average, f107Daily, magneticIndex)`

`[T rho] = atmosnrlmsise00(altitude, latitude, longitude, year, dayOfYear, UTseconds, flags)`

`[T rho] = atmosnrlmsise00(altitude, latitude, longitude, year, dayOfYear, UTseconds, otype)`

`[T rho] = atmosnrlmsise00(altitude, latitude, longitude, year, dayOfYear, UTseconds, action)`

### Description

`[T rho] = atmosnrlmsise00(altitude, latitude, longitude, year, dayOfYear, UTseconds)` implements the mathematical representation of the 2001 United States Naval Research Laboratory Mass Spectrometer and Incoherent Scatter Radar Exosphere (NRLMSISE-00) of the MSIS<sup>®</sup> class model. NRLMSISE-00 calculates the neutral atmosphere empirical model from the surface to lower exosphere (0 m to 1,000,000 m). Optionally, it performs this calculation including contributions from anomalous oxygen that can affect satellite drag above 500,000 m.

`[T rho] = atmosnrlmsise00(altitude, latitude, longitude, year, dayOfYear, UTseconds, localApparentSolarTime)` specifies an array of *m* local apparent solar time (hours).

`[T rho] = atmosnrlmsise00(altitude, latitude, longitude, year, dayOfYear, UTseconds, f107Average, f107Daily, magneticIndex)` specifies

arrays of  $m$  81 day average of F10.7 flux (centered on `day`),  $m$ -by-1 daily F10.7 flux for previous day, and  $m$ -by-7 of magnetic index information.

`[T rho] = atmosnrlmsise00(altitude, latitude, longitude, year, dayOfYear, UTseconds, flags)` specifies an array of 23 to enable or disable particular variations for the outputs.

`[T rho] = atmosnrlmsise00(altitude, latitude, longitude, year, dayOfYear, UTseconds, otype)` specifies a character vector for total mass density output.

`[T rho] = atmosnrlmsise00(altitude, latitude, longitude, year, dayOfYear, UTseconds, action)` specifies out-of-range input action.

This function has the limitations of the NRLMSISE-00 model. For more information, see the NRLMSISE-00 model documentation.

The NRLMSISE-00 model uses `UTseconds`, `localApparentSolarTime`, and `longitude` independently. These arguments are not of equal importance for every situation. For the most physically realistic calculation, choose these three variables to be consistent by default:

$$\text{localApparentSolarTime} = \text{UTseconds}/3600 + \text{longitude}/15$$

If available, you can include departures from this equation for `localApparentSolarTime`, but they are of minor importance.

## Input Arguments

### **action**

Action for out-of-range input. Specify one:

'Error'

'Warning' (default)

'None'

### **altitude**

Array of  $m$ -by-1 altitudes, in meters.

### **dayOfYear**

Array  $m$ -by-1 day of year.

### **f107Average**

Array of  $m$ -by-1 81 day average of F10.7 flux (centered on day of year (*dayOfYear*)). If you specify *f107Average*, you must also specify *f107Daily* and *magneticIndex*. The effects of *f107Average* are not large or established below 80,000 m; therefore, the default value is 150.

These *f107Average* values correspond to the 10.7 cm radio flux at the actual distance of the Earth from the Sun. The *f107Average* values do not correspond to the radio flux at 1 AU. The following site provides both classes of values: <ftp://ftp.ngdc.noaa.gov/STP/space-weather/solar-data/solar-features/solar-radio/noontime-flux/penticton/>

See the limitations in “Description” on page 4-82 for more information.

### **f107Daily**

Array of  $m$ -by-1 daily F10.7 flux for previous day. If you specify *f107Daily*, you must also specify *f107Average* and *magneticIndex*. The effects of *f107Daily* are not large or established below 80,000 m; therefore, the default value is 150.

These *f107Daily* values correspond to the 10.7 cm radio flux at the actual distance of the Earth from the Sun. The *f107Daily* values do not correspond to the radio flux at 1 AU. The following site provides both classes of values: <ftp://ftp.ngdc.noaa.gov/STP/space-weather/solar-data/solar-features/solar-radio/noontime-flux/penticton/>

See the limitations in “Description” on page 4-82 for more information.

### **flags**

Array of 23 to enable or disable particular variations for the outputs. If *flags* array length,  $m$ , is 23 and you have not specified all available inputs, this function assumes that *flags* is set.

The flags, associated with the *flags* input, enable or disable particular variations for the outputs:

Field	Description
Flags(1)	F10.7 effect on mean
Flags(2)	Independent of time
Flags(3)	Symmetrical annual
Flags(4)	Symmetrical semiannual
Flags(5)	Asymmetrical annual
Flags(6)	Asymmetrical semiannual
Flags(7)	Diurnal
Flags(8)	Semidiurnal
Flags(9)	Daily AP. If you set this field to -1, the block uses the entire matrix of magnetic index information (APH) instead of APH(:,1).
Flags(10)	All UT, longitudinal effects
Flags(11)	Longitudinal
Flags(12)	UT and mixed UT, longitudinal
Flags(13)	Mixed AP, UT, longitudinal
Flags(14)	Terdiurnal
Flags(15)	Departures from diffusive equilibrium
Flags(16)	All exospheric temperature variations
Flags(17)	All variations from 120,000 meter temperature (TLB)
Flags(18)	All lower thermosphere (TN1) temperature variations
Flags(19)	All 120,000 meter gradient (S) variations
Flags(20)	All upper stratosphere (TN2) temperature variations
Flags(21)	All variations from 120,000 meter values (ZLB)
Flags(22)	All lower mesosphere temperature (TN3) variations
Flags(23)	Turbopause scale height variations

### latitude

Array of  $m$ -by-1 geodetic latitudes, in degrees.

### longitude

Array of  $m$ -by-1 longitudes, in degrees.

**localApparentSolarTime**

Array of  $m$ -by-1 local apparent solar time (hours). To obtain a physically realistic value, the function sets *localApparentSolarTime* to  $(\text{sec}/3600 + 1\text{on}/15)$  by default. See “Description” on page 4-82 for more information.

**magneticIndex**

An array of  $m$ -by-7 of magnetic index information. If you specify *magneticIndex*, you must also specify *f107Average* and *f107Daily*. This information consists of:

Daily magnetic index (AP)

3 hour AP for current time

3 hour AP for 3 hours before current time

3 hour AP for 6 hours before current time

3 hour AP for 9 hours before current time

Average of eight 3 hour AP indices from 12 to 33 hours before current time

Average of eight 3 hour AP indices from 36 to 57 hours before current time

The effects of daily magnetic index are not large or established below 80,000 m. As a result, the function sets the default value to 4. See the limitations in “Description” on page 4-82 for more information.

**otype**

Total mass density output:

‘Oxygen’            Total mass density outputs include anomalous oxygen number density.

‘NoOxygen’        Total mass density outputs do not include anomalous oxygen number density.

**UTseconds**

Array of  $m$ -by-1 seconds in day in universal time (UT)

**year**

This function ignores the value of *year*.

## Output Arguments

### T

Array of  $N$ -by-2 values of temperature, in kelvin. The first column is exospheric temperature, in kelvin. The second column is temperature at altitude, in kelvin.

### rho

An array of  $N$ -by-9 values of densities ( $\text{kg}/\text{m}^3$  or  $1/\text{m}^3$ ) in selected density units. The column order is:

Density of He, in  $1/\text{m}^3$

Density of O, in  $1/\text{m}^3$

Density of N<sub>2</sub>, in  $1/\text{m}^3$

Density of O<sub>2</sub>, in  $1/\text{m}^3$

Density of Ar, in  $1/\text{m}^3$

Total mass density, in  $\text{kg}/\text{m}^3$

Density of H, in  $1/\text{m}^3$

Density of N, in  $1/\text{m}^3$

Anomalous oxygen number density, in  $1/\text{m}^3$

`density(6)`, total mass density, is the sum of the mass densities of He, O, N<sub>2</sub>, O<sub>2</sub>, Ar, H, and N. Optionally, `density(6)` can include the mass density of anomalous oxygen making `density(6)`, the effective total mass density for drag.

## Examples

Calculate the temperatures, densities not including anomalous oxygen using the NRLMSISE-00 model at 10,000 m, 45 degrees latitude, -50 degrees longitude. This calculation uses the date January 4, 2007 at 0 UT. It uses default values for flux, magnetic index data, and local solar time with out-of-range actions generating warnings:

```
[T rho] = atmosnrlmsise00( 10000, 45, -50, 2007, 4, 0)
```

```
T =
```

```
    281.6500    216.6500    216.6500
```

```
a =
```

```

336.4341 295.0696 295.0696
P =
1.0e+004 *
8.9875 2.2632 0.5475
rho =
1.1116 0.3639 0.0880
>> [T rho] = atmosnrlmsise00( 10000, 45, -50, 2007, 4, 0)
T =
1.0e+003 *
1.0273 0.2212
rho =
1.0e+024 *
0.0000 0 6.6824 1.7927 0.0799 0.0000 0 0 0

```

Calculate the temperatures, densities not including anomalous oxygen using the NRLMSISE-00 model. Use the model at 10,000 m, 45 degrees latitude, -50 degrees longitude and 25,000 m, 47 degrees latitude, -55 degrees longitude.

This calculation uses the date January 4, 2007 at 0 UT. It uses default values for flux, magnetic index data, and local solar time with out-of-range actions generating warnings:

```

[T rho] = atmosnrlmsise00( [10000; 25000], [45; 47], ...
[-50; -55], [2007; 2007], [4; 4], [0; 0])
[-50; -55], [2007; 2007], [4; 4], [0; 0])
T =
1.0e+003 *
1.0273 0.2212
1.0273 0.2116
rho =
1.0e+024 *
0.0000 0 6.6824 1.7927 0.0799 0.0000 0 0 0
0.0000 0 0.6347 0.1703 0.0076 0.0000 0 0 0

```



Calculate the temperatures, densities including anomalous oxygen using the NRLMSISE-00 model at 10,000 m, 45 degrees latitude, -50 degrees longitude. This calculation uses the date January 4, 2007 at 0 UT. It uses default values for flux, magnetic index data, and local solar time with out-of-range actions generating errors:

```
[T rho] = atmosnrlmsise00( 10000, 45, -50, 2007, ...
4, 0, 'Oxygen', 'Error')
```

T =

```
1.0e+003 *
1.0273    0.2212
```

rho =

```
1.0e+024 *
0.0000    0    6.6824    1.7927    0.0799    0.0000    0    0    0
```

Calculate the temperatures, densities including anomalous oxygen using the NRLMSISE-00 model at 100,000 m, 45 degrees latitude, -50 degrees longitude. This calculation uses the date January 4, 2007 at 0 UT. It uses defined values for flux, and magnetic index data, and default local solar time. It specifies that the out-of-range action is to generate no message:

```
aph = [17.375 15 20 15 27 (32+22+15+22+9+18+12+15)/8 (39+27+9+32+39+9+7+12)/8]
f107 = 87.7
nov_6days = [ 78.6 78.2 82.4 85.5 85.0 84.1]
dec_31daymean = 84.5
jan_31daymean = 83.5
feb_13days = [ 89.9 90.3 87.3 83.7 83.0 81.9 82.0 78.4 76.7 75.9 74.7 73.6 72.7]
f107a = (sum(nov_6days) + sum(feb_13days) + (dec_31daymean + jan_31daymean)*31)/81
flags = ones(1,23)
flags(9) = -1
[T rho] = atmosnrlmsise00( 100000, 45, -50, 2007, 4, 0, f107a, f107, ...
aph, flags, 'Oxygen', 'None')
```

aph =

```
17.3750    15.0000    20.0000    15.0000    27.0000    18.1250    21.7500
```

f107 =

```
87.7000
```

nov\_6days =

```
78.6000    78.2000    82.4000    85.5000    85.0000    84.1000
```

dec\_31daymean =

```
84.5000
```

## 4 Alphabetical List

---

jan\_31daymean =

83.5000

feb\_13days =

Columns 1 through 10

89.9000 90.3000 87.3000 83.7000 83.0000 81.9000 82.0000 78.4000 76.7000 75.9000

Columns 11 through 13

74.7000 73.6000 72.7000

f107a =

83.3568

flags =

Columns 1 through 17

1 1 1 1 1 1 1 1 1 1 1 1 1 1 1 1 1

Columns 18 through 23

1 1 1 1 1 1

flags =

Columns 1 through 17

1 1 1 1 1 1 1 1 -1 1 1 1 1 1 1 1 1

Columns 18 through 23

1 1 1 1 1 1

T =

1.0e+003 \*

1.0273 0.1917

rho =

1.0e+018 \*

0.0001 0.4241 7.8432 1.9721 0.0808 0.0000 0.0000 0.0000 0.0000

## References

<http://ccmc.gsfc.nasa.gov/modelweb/atmos/nr1msise00.html>

## See Also

atmoscira

**Introduced in R2007b**

# atmospalt

Calculate pressure altitude based on ambient pressure

## Syntax

```
pressureAltitude = atmospalt(pressure, action)
```

## Description

*pressureAltitude* = atmospalt(*pressure*, *action*) computes the pressure altitude based on ambient pressure. Pressure altitude is the altitude with specified ambient pressure in the 1976 Committee on Extension to the Standard Atmosphere (COESA) United States standard. Pressure altitude is the same as the mean sea level (MSL) altitude.

This function extrapolates altitude values logarithmically below the pressure of 0.3961 Pa (approximately 0.00006 psi) and above the pressure of 101,325 Pa (approximately 14.7 psi).

This function assumes that air is dry and an ideal gas.

## Input Arguments

### **pressure**

Array of *m*-by-1 ambient pressures, in pascal.

### **action**

Action for out-of-range input. Specify one:

'Error'

'Warning' (default)

'None'

## Output Arguments

### pressureAltitude

Array of  $m$ -by-1 pressure altitudes or MSL altitudes, in meters.

## Examples

Calculate the pressure altitude at a static pressure of 101,325 Pa with warnings for out-of-range inputs:

```
h = atmospalt(101325)
```

```
h =
```

```
0
```

Calculate the pressure altitude at static pressures of 101,325 Pa and 26,436 Pa with errors for out-of-range inputs:

```
h = atmospalt([101325 26436], 'Error' )
```

```
h =
```

```
1.0e+004 *
```

```
0    1.0000
```

## References

*U.S. Standard Atmosphere*, 1976, U.S. Government Printing Office, Washington, D.C.

## See Also

atmoscira | atmoscoesa | atmosisa | atmoslapse | atmosnonstd

Introduced in R2006b

## Body (Aero.Body)

Construct body object for use with animation object

### Syntax

```
h = Aero.Body
```

### Description

`h = Aero.Body` constructs a body for an animation object. The animation object is returned in `h`. To use the `Aero.Body` object, you typically:

- 1 Create the animation body.
- 2 Configure or customize the body object.
- 3 Load the body.
- 4 Generate patches for the body (requires an axes from a figure).
- 5 Set the source for the time series data.
- 6 Move or update the body.

The animation object has the following properties:

By default, an `Aero.Body` object natively uses aerospace body coordinates for the body geometry and the time series data. Convert time series data from other coordinate systems on the fly by registering a different `CoordTransformFcn` function.

See `Aero.Body` for further details.

### See Also

`Aero.Body`

Introduced in R2007a

## Camera (Aero.Camera)

Construct camera object for use with animation object

### Syntax

`h = Aero.Camera`

### Description

`h = Aero.Camera` constructs a camera object `h` for use with an animation object. The camera object uses the registered coordinate transform. By default, this is an aerospace body coordinate system. Axes of custom coordinate systems must be orthogonal.

The animation object has the following properties:

By default, an `Aero.Body` object natively uses aerospace body coordinates for the body geometry and the time series data. Convert time series data from other coordinate systems on the fly by registering a different `CoordTransformFcn` function.

See `Aero.Camera` for further details.

### See Also

`Aero.Camera`

Introduced in R2007a

## ClearTimer (Aero.FlightGearAnimation)

Clear and delete timer for animation of FlightGear flight simulator

### Syntax

```
ClearTimer(h)  
h.ClearTimer
```

### Description

`ClearTimer(h)` and `h.ClearTimer` clear and delete the MATLAB timer for the animation of the FlightGear flight simulator.

### Examples

Clear and delete the MATLAB timer for animation of the FlightGear animation object, `h`:

```
h = Aero.FlightGearAnimation  
h.SetTimer  
h.ClearTimer  
h.SetTimer('FGTimer')
```

### See Also

`SetTimer`

**Introduced in R2008b**



## convacc

Convert from acceleration units to desired acceleration units

### Syntax

```
convertedValues = convacc(valuesToConvert, inputAccelUnits,  
outputAccelUnits)
```

### Description

*convertedValues* = convacc(*valuesToConvert*, *inputAccelUnits*, *outputAccelUnits*) computes the conversion factor from specified input acceleration units to specified output acceleration units. It then applies the conversion factor to the input to produce the output in the desired units.

### Input Arguments

#### **valuesToConvert**

Floating-point array of size *m*-by-*n* values that the function is to convert. All values must have the same unit conversions from *inputAccelUnits* to *outputAccelUnits*.

#### **inputAccelUnits**

Specified input acceleration units. Supported units are:

'ft/s^2'	Feet per second squared
'm/s^2'	Meters per second squared
'km/s^2'	Kilometers per second squared
'in/s^2'	Inches per second squared
'km/h-s'	Kilometers per hour per second
'mph/s'	Miles per hour per second
'G''s'	g-units

### **outputAccelUnits**

Specified output acceleration units. Supported units are:

'ft/s^2'	Feet per second squared
'm/s^2'	Meters per second squared
'km/s^2'	Kilometers per second squared
'in/s^2'	Inches per second squared
'km/h-s'	Kilometers per hour per second
'mph/s'	Miles per hour per second
'G''s'	g-units

## **Output Arguments**

### **convertedValues**

Floating-point array of size  $m$ -by- $n$  values that the function has converted.

## **Examples**

Convert three accelerations from feet per second squared to meters per second squared:

```
a = convacc([3 10 20], 'ft/s^2', 'm/s^2')
```

```
a =
```

```
    0.9144    3.0480    6.0960
```

## **See Also**

convang | convangacc | convangvel | convdensity | convforce | convlength |  
convmass | convpres | convtemp | convvel

**Introduced in R2006b**

## convang

Convert from angle units to desired angle units

### Syntax

```
convertedValues = convang(valuesToConvert, inputAngleUnits,  
outputAngleUnits)
```

### Description

*convertedValues* = convang(*valuesToConvert*, *inputAngleUnits*, *outputAngleUnits*) computes the conversion factor from specified input angle units to specified output angle units. It then applies the conversion factor to the input to produce the output in the desired units. *inputAngleUnits* and *outputAngleUnits* are character vectors.

### Input Arguments

#### **valuesToConvert**

Floating-point array of size *m*-by-*n* values the function is to convert. All values must have the same unit conversions from *inputAngleUnits* to *outputAngleUnits*.

#### **inputAngleUnits**

Specified input angle units. Supported units are:

'deg'	Degrees
'rad'	Radians
'rev'	Revolutions

#### **outputAngleUnits**

Specified output angle units. Supported units are:

'deg'	Degrees
'rad'	Radians
'rev'	Revolutions

## Output Arguments

### **convertedValues**

Floating-point array of size  $m$ -by- $n$  values that the function has converted.

## Examples

Convert three angles from degrees to radians:

```
a = convang([3 10 20], 'deg', 'rad')
```

```
a =
```

```
    0.0524    0.1745    0.3491
```

## See Also

[convacc](#) | [convangacc](#) | [convangvel](#) | [convdensity](#) | [convforce](#) | [convlength](#) | [convmass](#) | [convpres](#) | [convtemp](#) | [convvel](#)

**Introduced in R2006b**

## convangacc

Convert from angular acceleration units to desired angular acceleration units

### Syntax

```
convertedValues = convangacc(valuesToConvert, inputAngularUnits,  
outputAngularUnits)
```

### Description

*convertedValues* = convangacc(*valuesToConvert*, *inputAngularUnits*, *outputAngularUnits*) computes the conversion factor from specified input angular acceleration units to specified output angular acceleration units. It then applies the conversion factor to the input to produce the output in the desired units.

### Input Arguments

#### **valuesToConvert**

Floating-point array of size *m*-by-*n* values that the function is to convert. All values must have the same unit conversions from *inputAngularUnits* to *outputAngularUnits*.

#### **inputAngularUnits**

Specified input angular acceleration units. Supported units are:

'deg/s^2'	Degrees per second squared
'rad/s^2'	Radians per second squared
'rpm/s'	Revolutions per minute per second

#### **outputAngularUnits**

Specified output angular acceleration units. Supported units are:

'deg/s^2'	Degrees per second squared
-----------	----------------------------

'rad/s^2'	Radians per second squared
'rpm/s'	Revolutions per minute per second

## Output Arguments

### **convertedValues**

Floating-point array of size *m-by-n* values that the function has converted.

## Examples

Convert three angular accelerations from degrees per second squared to radians per second squared:

```
a = convangacc([0.3 0.1 0.5], 'deg/s^2', 'rad/s^2')
```

```
a =
```

```
    0.0052    0.0017    0.0087
```

## See Also

convacc | convang | convangvel | convdensity | convforce | convlength | convmass | convpres | convtemp | convvel

**Introduced in R2006b**

# convangvel

Convert from angular velocity units to desired angular velocity units

## Syntax

```
convertedValues = convangvel(valuesToConvert,  
inputAngularVelocityUnits, outputAngularVelocityUnits)
```

## Description

*convertedValues* = convangvel(*valuesToConvert*, *inputAngularVelocityUnits*, *outputAngularVelocityUnits*) computes the conversion factor from specified input angular velocity units to specified output angular velocity units. It then applies the conversion factor to the input to produce the output in the desired units.

## Input Arguments

### **valuesToConvert**

Floating-point array of size *m*-by-*n* values that the function is to convert. All values must have the same unit conversions from *inputAngularVelocityUnits* to *outputAngularVelocityUnits*.

### **inputAngularVelocityUnits**

Specified input angular velocity units. Supported units are:

'deg/s'	Degrees per second
'rad/s'	Radians per second
'rpm'	Revolutions per minute

### **outputAngularVelocityUnits**

Specified output angular velocity units. Supported units are:

'deg/s'	Degrees per second
'rad/s'	Radians per second
'rpm'	Revolutions per minute

## Output Arguments

### **convertedValues**

Floating-point array of size  $m$ -by- $n$  values that the function has converted.

## Examples

Convert three angular velocities from degrees per second to radians per second:

```
a = convangvel([0.3 0.1 0.5], 'deg/s', 'rad/s')
```

```
a =
```

```
    0.0052    0.0017    0.0087
```

## See Also

convacc | convang | convangacc | convdensity | convforce | convlength | convmass | convpres | convtemp | convvel

**Introduced in R2006b**



# convdensity

Convert from density units to desired density units

## Syntax

```
convertedValues = convdensity(valuesToConvert, inputDensityUnits,  
outputDensityUnits)
```

## Description

*convertedValues* = convdensity(*valuesToConvert*, *inputDensityUnits*, *outputDensityUnits*) computes the conversion factor from specified input density units to specified output density units. It then applies the conversion factor to the input to produce the output in the desired units.

## Input Arguments

### **valuesToConvert**

Floating-point array of size *m*-by-*n* values that the function is to convert. All values must have the same unit conversions from *inputDensityUnits* to *outputDensityUnits*.

### **inputDensityUnits**

Specified input density units. Supported units are:

'lbm/ft^3'	Pound mass per feet cubed
'kg/m^3'	Kilograms per meters cubed
'slug/ft^3'	Slugs per feet cubed
'lbm/in^3'	Pound mass per inch cubed

### **outputDensityUnits**

Specified output density units. Supported units are:

'lbm/ft^3'	Pound mass per feet cubed
'kg/m^3'	Kilograms per meters cubed
'slug/ft^3'	Slugs per feet cubed
'lbm/in^3'	Pound mass per inch cubed

## Output Arguments

### **convertedValues**

Floating-point array of size  $m$ -by- $n$  values that the function has converted.

## Examples

Convert three densities from pound mass per feet cubed to kilograms per meters cubed:

```
a = convdensity([0.3 0.1 0.5], 'lbm/ft^3', 'kg/m^3')
```

```
a =
```

```
    4.8055    1.6018    8.0092
```

## See Also

convacc | convang | convangacc | convangvel | convforce | convlength | convmass | convpres | convtemp | convvel

**Introduced in R2006b**

# convforce

Convert from force units to desired force units

## Syntax

```
convertedValues = convforce(valuesToConvert, inputForceUnits,  
outputForceUnits)
```

## Description

*convertedValues* = convforce(*valuesToConvert*, *inputForceUnits*, *outputForceUnits*) computes the conversion factor from specified input force units to specified output force units. It then applies the conversion factor to the input to produce the output in the desired units.

## Input Arguments

### **valuesToConvert**

Floating-point array of size *m*-by-*n* values that the function is to convert. All values must have the same unit conversions from *inputForceUnits* to *outputForceUnits*.

### **inputForceUnits**

Specified input force units. Supported units are:

'lbf'	Pound force
'N'	Newton

### **outputForceUnits**

Specified output force units. Supported units are:

'lbf'	Pound force
-------	-------------

'N'

Newton

## Output Arguments

### **convertedValues**

Floating-point array of size  $m$ -by- $n$  values that the function has converted.

## Examples

Convert three forces from pound force to newtons:

```
a = convforce([120 1 5], 'lbf', 'N')
```

```
a =
```

```
533.7866    4.4482    22.2411
```

## See Also

convacc | convang | convangacc | convangvel | convdensity | convlength |  
convmass | convpres | convtemp | convvel

**Introduced in R2006b**

# convlength

Convert from length units to desired length units

## Syntax

```
convertedValues = convlength(valuesToConvert, inputLengthUnits,  
outputLengthUnits)  
m
```

## Description

*convertedValues* = convlength(*valuesToConvert*, *inputLengthUnits*, *outputLengthUnits*) computes the conversion factor from specified input length units to specified output length units. It then applies the conversion factor to the input to produce the output in the desired units.

## Input Arguments

### **valuesToConvert**

Floating-point array of size *m*-by-*n* values that the function is to convert. All values must have the same unit conversions from *inputLengthUnits* to *outputLengthUnits*.

### **inputLengthUnits**

Specified input length units. Supported units are:

'ft'	Feet
'm'	Meters
'km'	Kilometers
'in'	Inches
'mi'	Miles
'naut mi'	Nautical miles

### **outputLengthUnits**

Specified output length units. Supported units are:

'ft'	Feet
'm'	Meters
'km'	Kilometers
'in'	Inches
'mi'	Miles
'naut mi'	Nautical miles

## **Output Arguments**

### **convertedValues**

Floating-point array of size  $m$ -by- $n$  values that the function has converted.

## **Examples**

Convert three lengths from feet to meters:

```
a = convlength([3 10 20], 'ft', 'm')
```

```
a =
```

```
    0.9144    3.0480    6.0960
```

## **See Also**

[convacc](#) | [convang](#) | [convangacc](#) | [convangvel](#) | [convdensity](#) | [convforce](#) | [convmass](#) | [convpres](#) | [convtemp](#) | [convvel](#)

**Introduced in R2006b**

## convmass

Convert from mass units to desired mass units

### Syntax

```
convertedValues = convmass(valuesToConvert, inputMassUnits,  
outputMassUnits)
```

### Description

*convertedValues* = convmass(*valuesToConvert*, *inputMassUnits*, *outputMassUnits*) computes the conversion factor from specified input mass units to specified output mass units. It then applies the conversion factor to the input to produce the output in the desired units.

### Input Arguments

#### **valuesToConvert**

Floating-point array of size *m*-by-*n* values that the function is to convert. All values must have the same unit conversions from *inputMassUnits* to *outputMassUnits*.

#### **inputMassUnits**

Specified input mass units. Supported units are:

'lbm'	Pound mass
'kg'	Kilograms
'slug'	Slugs

#### **outputMassUnits**

Specified output mass units. Supported units are:

'lbm'	Pound mass
-------	------------

'kg'	Kilograms
'slug'	Slugs

## Output Arguments

### **convertedValues**

Floating-point array of size  $m$ -by- $n$  values that the function has converted.

## Examples

Convert three masses from pound mass to kilograms:

```
a = convmass([3 1 5], 'lbm', 'kg')
```

```
a =
```

```
    1.3608    0.4536    2.2680
```

## See Also

[convacc](#) | [convang](#) | [convangacc](#) | [convangvel](#) | [convdensity](#) | [convforce](#) | [convlength](#) | [convpres](#) | [convtemp](#) | [convvel](#)

**Introduced in R2006b**



## convpres

Convert from pressure units to desired pressure units

### Syntax

```
convertedValues = convpres(valuesToConvert, inputPressureUnits,  
outputPressureUnits)
```

### Description

*convertedValues* = convpres(*valuesToConvert*, *inputPressureUnits*, *outputPressureUnits*) computes the conversion factor from specified input pressure units to specified output pressure units. It then applies the conversion factor to the input to produce the output in the desired units.

### Input Arguments

#### **valuesToConvert**

Floating-point array of size *m*-by-*n* values that the function is to convert. All values must have the same unit conversions from *inputPressureUnits* to *outputPressureUnits*.

#### **inputPressureUnits**

Specified input pressure units. Supported units are:

'psi'	Pound force per square inch
'Pa'	Pascal
'psf'	Pound force per square foot
'atm'	Atmosphere

#### **outputPressureUnits**

Specified output pressure units. Supported units are:

'psi'	Pound force per square inch
'Pa'	Pascal
'psf'	Pound force per square foot
'atm'	Atmosphere

## Output Arguments

### **convertedValues**

Floating-point array of size  $m$ -by- $n$  values that the function has converted.

## Examples

Convert two pressures from pound force per square inch to atmospheres:

```
a = convpres([14.696 35], 'psi', 'atm')
```

```
a =
```

```
1.0000    2.3816
```

## See Also

convacc | convang | convangacc | convangvel | convdensity | convforce |  
convlength | convmass | convtemp | convvel

**Introduced in R2006b**

## convtemp

Convert from temperature units to desired temperature units

### Syntax

```
convertedValues = convtemp(valuesToConvert, inputTemperatureUnits,  
outputTemperatureUnits)
```

### Description

*convertedValues* = convtemp(*valuesToConvert*, *inputTemperatureUnits*, *outputTemperatureUnits*) computes the conversion factor from specified input temperature units to specified output temperature units. It then applies the conversion factor to the input, to produce the output in the desired units.

### Input Arguments

#### **valuesToConvert**

Floating-point array of size *m*-by-*n* values that the function is to convert. All values must have the same unit conversions from *inputTemperatureUnits* to *outputTemperatureUnits*.

#### **inputTemperatureUnits**

Specified input temperature units. Supported units are:

'K'	Kelvin
'F'	Degrees Fahrenheit
'C'	Degrees Celsius
'R'	Degrees Rankine

#### **outputTemperatureUnits**

Specified output temperature units. Supported units are:

'K'	Kelvin
'F'	Degrees Fahrenheit
'C'	Degrees Celsius
'R'	Degrees Rankine

## Output Arguments

### **convertedValues**

Floating-point array of size  $m$ -by- $n$  values that the function has converted.

## Examples

Convert three temperatures from degrees Celsius to degrees Fahrenheit:

```
a = convtemp([0 100 15], 'C', 'F')
```

```
a =
```

```
32.0000 212.0000 59.0000
```

## See Also

[convacc](#) | [convang](#) | [convangacc](#) | [convangvel](#) | [convdensity](#) | [convforce](#) | [convlength](#) | [convmass](#) | [convpres](#) | [convvel](#)

**Introduced in R2006b**

# convvel

Convert from velocity units to desired velocity units

## Syntax

```
convertedValues = convvel(valuesToConvert, inputVelocityUnits,  
outputVelocityUnits)
```

## Description

*convertedValues* = convvel(*valuesToConvert*, *inputVelocityUnits*, *outputVelocityUnits*) computes the conversion factor from specified input velocity units to specified output velocity units. It then applies the conversion factor to the input to produce the output in the desired units.

## Input Arguments

### **valuesToConvert**

Floating-point array of size *m*-by-*n* values that the function is to convert. All values must have the same unit conversions from *inputVelocityUnits* to *outputVelocityUnits*.

### **inputVelocityUnits**

Specified input velocity units. Supported units are:

'ft/s'	Feet per second
'm/s'	Meters per second
'km/s'	Kilometers per second
'in/s'	Inches per second
'km/h'	Kilometers per hour
'mph'	Miles per hour
'kts'	Knots

'ft/min'                      Feet per minute

### **outputVelocityUnits**

Specified output velocity units. Supported units are:

'ft/s'                      Feet per second  
'm/s'                      Meters per second  
'km/s'                      Kilometers per second  
'in/s'                      Inches per second  
'km/h'                      Kilometers per hour  
'mph'                      Miles per hour  
'kts'                      Knots  
'ft/min'                      Feet per minute

## **Output Arguments**

### **convertedValues**

Floating-point array of size  $m$ -by- $n$  values that the function has converted.

## **Examples**

Convert three velocities from feet per minute to meters per second:

```
a = convvel([30 100 250], 'ft/min', 'm/s')
```

```
a =
```

```
    0.1524    0.5080    1.2700
```

## **See Also**

convacc | convang | convangacc | convangvel | convdensity | convforce | convlength | convmass | convpres | convtemp

**Introduced in R2006b**

## correctairspeed

Convert from one of other two airspeeds to equivalent airspeed (EAS), calibrated airspeed (CAS), or true airspeed (TAS)

### Syntax

```
outputAirpseed = correctairspeed(inputAirspeed, speedOfSound,  
pressure0, inputAirspeedType, outputAirspeedType)
```

### Description

*outputAirpseed* = correctairspeed(*inputAirspeed*, *speedOfSound*, *pressure0*, *inputAirspeedType*, *outputAirspeedType*) computes the conversion factor from specified input airspeed to specified output airspeed using speed of sound and static pressure. The function applies the conversion factor to the input airspeed to produce the output in the desired airspeed.

This function is based on an assumption of compressible, isentropic (subsonic flow), dry air with constant specific heat ratio ( $\gamma$ ).

## Input Arguments

### **inputAirspeed**

Floating-point array of size  $m$ -by-1 of airspeeds in meters per second. All values must have the same airspeed conversions from *inputAirspeedType* to *outputAirspeedType*.

### **speedOfSound**

Floating-point array of size  $m$ -by-1 of speeds of sound, in meters per second.

### **pressure0**

Floating-point array of size  $m$ -by-1 of static air pressures, in pascal.



**inputAirspeedType**

Input airspeed. Supported airspeeds are:

'TAS'	True airspeed
'CAS'	Calibrated airspeed
'EAS'	Equivalent airspeed

**outputAirspeedType**

Output airspeed. Supported airspeeds are:

'TAS'	True airspeed
'CAS'	Calibrated airspeed
'EAS'	Equivalent airspeed

## Output Arguments

**outputAirpseed**

Floating-point array of size  $m$ -by-1 of airspeeds in meters per second.

## Examples

Convert three airspeeds from true airspeed to equivalent airspeed at 1000 ms:

```
as = correctairspeed([25.7222; 10.2889; 3.0867], 336.4, 89874.6, 'TAS', 'EAS')
as =
    24.5057
     9.8023
     2.9407
```

Convert airspeeds from true airspeed to equivalent airspeed at 1000 m and 0 m:

```
ain = [25.7222; 10.2889; 3.0867];
sos = [336.4; 340.3; 340.3];
PO = [89874.6; 101325; 101325];
as = correctairspeed(ain, sos, PO, 'TAS', 'EAS')
```

as =

24.5057

10.2887

3.0866

## References

Lowry, J.T., *Performance of Light Aircraft*, AIAA Education Series, Washington, D.C., 1999

*Aeronautical Vestpocket Handbook*, United Technologies Pratt & Whitney, August 1986

## See Also

airspeed

**Introduced in R2006b**

# createBody

**Class:** Aero.Animation

**Package:** Aero

Create body and its associated patches in animation

## Syntax

```
idx = createBody(h,bodyDataSrc)
idx = h.createBody(bodyDataSrc)
idx = createBody(h,bodyDataSrc,geometrystate)
idx = h.createBody(bodyDataSrc,geometrystate)
```

## Description

`idx = createBody(h,bodyDataSrc)` and `idx = h.createBody(bodyDataSrc)` create a new body using the `bodyDataSrc`, makes its patches, and adds it to the animation object `h`. This command assumes a default geometry source type set to `Auto`.

`idx = createBody(h,bodyDataSrc,geometrystate)` and `idx = h.createBody(bodyDataSrc,geometrystate)` create a new body using the `bodyDataSrc` file, makes its patches, and adds it to the animation object `h`. `geometrystate` is the geometry source type for the body.

## Input Arguments

<code>bodyDataSrc</code>	Source of data for body.
<code>geometrystate</code>	Geometry source type for body: <ul style="list-style-type: none"><li>• <code>Auto</code> — Recognizes <code>.mat</code> extensions as MAT-files, <code>.ac</code> extensions as Ac3d files, and structures containing fields of <code>name</code>, <code>faces</code>, <code>vertices</code>, and <code>cdata</code> as MATLAB variables. Default.</li><li>• <code>Variable</code> — Recognizes structures containing fields of <code>name</code>, <code>faces</code>, <code>vertices</code>, and <code>cdata</code> as MATLAB variables.</li></ul>

- `MatFile` — Recognizes `.mat` extensions as MAT-files.
- `Ac3d` — Recognizes `.ac` extensions as Ac3d files.
- `Custom` — Recognizes custom extensions.

## Output Arguments

`idx`                      Index of the body to be created.

## Examples

Create a body for the animation object, `h`. Use the Ac3d format data source `pa24-250_orange.ac`, for the body.

```
h = Aero.Animation;  
idx1 = h.createBody('pa24-250_orange.ac', 'Ac3d');
```

# datcomimport

Bring DATCOM file into MATLAB environment

## Syntax

```
aero = datcomimport(file)
aero = datcomimport(file, usenan)
aero = datcomimport(file, usenan, verbose)
aero = datcomimport(file, usenan, verbose, filetype)
```

## Description

`aero = datcomimport(file)` takes a file name, `file`, as a character vector (or a cell array of file names as character vectors), and imports aerodynamic data from `file` into a cell array of structures, `aero`. Before reading the DATCOM file, the function initializes values to 99999 to show when there is not a full set of data for the DATCOM case.

`aero = datcomimport(file, usenan)` is an alternate method allowing the replacement of data points with NaN or zero where no DATCOM methods exist or where the method is not applicable. The default value for `usenan` is `true`.

`aero = datcomimport(file, usenan, verbose)` is an alternate method to display the status of the DATCOM file being read. The default value for `verbose` is `2`, which displays a wait bar. Other options are `0`, which displays no information, and `1`, which displays text to the MATLAB Command Window.

`aero = datcomimport(file, usenan, verbose, filetype)` is an alternate method that allows you to specify which type of DATCOM file to read. The possible values are listed in this table:

filetype Value	Output File from DATCOM
6	(Default) for006.dat output by all DATCOM versions
21	for021.dat output by DATCOM 2007, DATCOM 2008, DATCOM 2011, and DATCOM 2014
42	for042.csv output by DATCOM 2008, DATCOM 2011, and DATCOM 2014

When `filetype` is 6, the function reads the `for006.dat` file output by DATCOM.

---

**Note:** If `filetype` is 21, the function collates the breakpoints and data from all the cases and appends them as the last entry of `aero`.

---

When `filetype` is 21, the function reads the `for021.dat` file output by DATCOM 2007.

When file type is 42, the function reads the `for042.csv` file output by DATCOM 2008, DATCOM 2011, and DATCOM 2014.

Fields for the 1976, 1999, 2007, 2008, 2011, and 2014 versions of the type 6 output files:

- “Fields for 1976 Version (File Type 6)” on page 4-126
- “Fields for 1999 Version (File Type 6)” on page 4-140
- “Fields for 2007, 2008, 2011, and 2014 Versions (File Type 6)” on page 4-144

Fields for 2007, 2008, 2011, and 2014 versions of the type 21 output file:

- “Fields for 2007, 2008, 2011, and 2014 Versions (File Type 21)” on page 4-148

Fields for 2008, 2011, and 2014 versions of the type 42 output file are described in:

- “Fields for 2008, 2011, and 2014 Version (File Type 42)” on page 4-153

### Fields for 1976 Version (File Type 6)

The fields of `aero` depend on the data within the DATCOM file.

#### Common Fields for the 1976 Version (File Type 6)

Field	Description	Default
<code>case</code>	Character vector containing the case ID.	[ ]
<code>mach</code>	Array of Mach numbers.	[ ]
<code>alt</code>	Array of altitudes.	[ ]
<code>alpha</code>	Array of angles of attack.	[ ]
<code>nmach</code>	Number of Mach numbers.	0

Field	Description	Default
nalt	Number of altitudes.	0
nalpa	Number of angles of attack.	0
rnnub	Array of Reynolds numbers.	[ ]
hypers	Logical denoting, when <b>true</b> , that mach numbers above <b>tsmach</b> are hypersonic. Default values are supersonic.	false
loop	Scalar denoting the type of looping done to generate the DATCOM file. When <b>loop</b> is 1, <b>mach</b> and <b>alt</b> are varied together. When <b>loop</b> is 2, <b>mach</b> varies while <b>alt</b> is fixed. Altitude is then updated and Mach numbers are cycled through again. When <b>loop</b> is 3, <b>mach</b> is fixed while <b>alt</b> varies. <b>mach</b> is then updated and altitudes are cycled through again.	1
sref	Scalar denoting the reference area for the case.	[ ]
cbar	Scalar denoting the longitudinal reference length.	[ ]
blref	Scalar denoting the lateral reference length.	[ ]
dim	Character vector denoting the specified system of units for the case.	'ft'
deriv	Character vector denoting the specified angle units for the case.	'deg'
stmach	Scalar value setting the upper limit of subsonic Mach numbers.	0.6
tsmach	Scalar value setting the lower limit of supersonic Mach numbers.	1.4
save	Logical denoting whether the input values for this case are used in the next case.	false

<b>Field</b>	<b>Description</b>	<b>Default</b>
stype	Scalar denoting the type of asymmetric flap for the case.	[ ]
trim	Logical denoting the reading of trim data for the case. When trim runs are read, this value is set to <b>true</b> .	false
damp	Logical denoting the reading of dynamic derivative data for the case. When dynamic derivative runs are read, this value is set to <b>true</b> .	false
build	Scalar denoting the reading of build data for the case. When build runs are read, this value is set to 10.	1
part	Logical denoting the reading of partial data for the case. When partial runs are written for each Mach number, this value is set to <b>true</b> .	false
highsym	Logical denoting the reading of symmetric flap high-lift data for the case. When symmetric flap runs are read, this value is set to <b>true</b> .	false
highasy	Logical denoting the reading of asymmetric flap high-lift data for the case. When asymmetric flap runs are read, this value is set to <b>true</b> .	false
highcon	Logical denoting the reading of control/trim tab high-lift data for the case. When control/trim tab runs are read, this value is set to <b>true</b> .	false
tjet	Logical denoting the reading of transverse-jet control data for the case. When transverse-jet control runs are read, this value is set to <b>true</b> .	false
hypeff	Logical denoting the reading of hypersonic flap effectiveness data for the	false



Field	Description	Default
	case. When hypersonic flap effectiveness runs are read, this value is set to <code>true</code> .	
<code>lb</code>	Logical denoting the reading of low aspect ratio wing or lifting body data for the case. When low aspect ratio wing or lifting body runs are read, this value is set to <code>true</code> .	<code>false</code>
<code>pwr</code>	Logical denoting the reading of power effects data for the case. When power effects runs are read, this value is set to <code>true</code> .	<code>false</code>
<code>grnd</code>	Logical denoting the reading of ground effects data for the case. When ground effects runs are read, this value is set to <code>true</code> .	<code>false</code>
<code>wsspn</code>	Scalar denoting the semi-span theoretical panel for wing. This value is used to determine if the configuration contains a canard.	1
<code>hsspn</code>	Scalar denoting the semi-span theoretical panel for horizontal tail. This value is used to determine if the configuration contains a canard.	1
<code>ndelta</code>	Number of control surface deflections: <code>delta</code> , <code>deltal</code> , or <code>deltar</code> .	0
<code>delta</code>	Array of control-surface streamwise deflection angles.	[ ]
<code>deltal</code>	Array of left lifting surface streamwise control deflection angles, which are defined positive for trailing-edge down.	[ ]
<code>deltar</code>	Array of right lifting surface streamwise control deflection angles, which are defined positive for trailing-edge down.	[ ]

Field	Description	Default
ngh	Scalar denoting the number of ground altitudes.	0
grndht	Array of ground heights.	[ ]
config	Structure of logicals denoting whether the case contains horizontal tails.	false, as follows.  <pre>config.downwash = false; config.body = false; config.wing = false; config.htail = false; config.vtail = false; config.vfin = false;</pre>
version	Version of DATCOM file.	1976

**Static Longitude and Lateral Stability Fields Available for the 1976 Version (File Type 6)**

Field	Matrix of...	Function of...
cd	Drag coefficients, which are defined positive for an aft-acting load.	alpha, mach, alt, build, grndht, delta
cl	Lift coefficients, which are defined positive for an up-acting load.	alpha, mach, alt, build, grndht, delta
cm	Pitching-moment coefficients, which are defined positive for a nose-up rotation.	alpha, mach, alt, build, grndht, delta
cn	Normal-force coefficients, which are defined positive for a normal force in the +Z direction.	alpha, mach, alt, build, grndht, delta
ca	Axial-force coefficients, which are defined positive for a normal force in the +X direction.	alpha, mach, alt, build, grndht, delta
xcp	Distances between moment reference center and the center of pressure divided by the longitudinal reference length. Distances are defined positive for a location forward of the center of gravity.	alpha, mach, alt, build, grndht, delta
cla	Derivatives of lift coefficients relative to alpha.	alpha, mach, alt, build, grndht, delta

Field	Matrix of...	Function of...
cma	Derivatives of pitching-moment coefficients relative to alpha.	alpha, mach, alt, build, grndht, delta
cyb	Derivatives of side-force coefficients relative to sideslip angle.	alpha, mach, alt, build, grndht, delta
cnb	Derivatives of yawing-moment coefficients relative to sideslip angle.	alpha, mach, alt, build, grndht, delta
clb	Derivatives of rolling-moment coefficients relative to sideslip angle.	alpha, mach, alt, build, grndht, delta
qqinf	Ratios of dynamic pressure at the horizontal tail to the freestream value.	alpha, mach, alt, build, grndht, delta
eps	Downwash angle at horizontal tail in degrees.	alpha, mach, alt, build, grndht, delta
depsdalp	Downwash angle relative to angle of attack.	alpha, mach, alt, build, grndht, delta

#### Dynamic Derivative Fields for the 1976 Version (File Type 6)

Field	Matrix of...	Function of...
clq	Rolling-moment derivatives due to pitch rate.	alpha, mach, alt, build
cmq	Pitching-moment derivatives due to pitch rate.	alpha, mach, alt, build
clad	Lift-force derivatives due to rate of angle of attack.	alpha, mach, alt, build
cmad	Pitching-moment derivatives due to rate of angle of attack.	alpha, mach, alt, build
clp	Rolling-moment derivatives due to roll rate.	alpha, mach, alt, build
cyp	Lateral-force derivatives due to roll rate.	alpha, mach, alt, build
cnp	Yawing-moment derivatives due to roll rate.	alpha, mach, alt, build
cnr	Yawing-moment derivatives due to yaw rate.	alpha, mach, alt, build
clr	Rolling-moment derivatives due to yaw rate.	alpha, mach, alt, build

#### High-Lift and Control Fields for Symmetric Flaps for the 1976 Version (File Type 6)

Field	Matrix of...	Function of...
dcl_sym	Incremental lift coefficients due to deflection of control surface, valid in the linear-lift angle of attack range.	delta, mach, alt
dcm_sym	Incremental pitching-moment coefficients due to deflection of control surface, valid in the linear-lift angle of attack range.	delta, mach, alt
dclmax_sym	Incremental maximum lift coefficients.	delta, mach, alt
dcdmin_sym	Incremental minimum drag coefficients due to control or flap deflection.	delta, mach, alt
clad_sym	Lift-curve slope of the deflected, translated surface.	delta, mach, alt
cha_sym	Control-surface hinge-moment derivatives due to angle of attack. These derivatives, when defined positive, tend to rotate the flap trailing edge down.	delta, mach, alt
chd_sym	Control-surface hinge-moment derivatives due to control deflection. When defined positive, these derivatives tend to rotate the flap trailing edge down.	delta, mach, alt
dcdi_sym	Incremental induced drag coefficients due to flap deflection.	alpha, delta, mach, alt

**High-Lift and Control Fields Available for Asymmetric Flaps for the 1976 Version (File Type 6)**

Field	Matrix of...	Function of...
xsc	Streamwise distances from wing leading edge to spoiler tip.	delta, mach, alt
hsc	Projected height of spoiler measured from normal to airfoil meanline.	delta, mach, alt
ddc	Projected height of deflector for spoiler-slot-deflector control.	delta, mach, alt
dsc	Projected height of spoiler control.	delta, mach, alt

Field	Matrix of...	Function of...
clroll	Incremental rolling-moment coefficients due to asymmetrical deflection of control surface. The coefficients are defined positive when right wing is down.	delta, mach, and alt, or alpha, delta, mach, and alt for differential horizontal stabilizer
cn_asy	Incremental yawing-moment coefficients due to asymmetrical deflection of control surface. The coefficients are defined positive when nose is right.	delta, mach, and alt, or alpha, delta, mach, and alt for plain flaps

#### High-Lift and Control Fields Available for Control/Trim Tabs for the 1976 Version (File Type 6)

Field	Matrix of...	Function of...
fc_con	Stick forces or stick force coefficients.	alpha, delta, mach, alt
fhmcoeff_free	Flap-hinge moment coefficients tab free.	alpha, delta, mach, alt
fhmcoeff_lock	Flap-hinge moment coefficients tab locked.	alpha, delta, mach, alt
fhmcoeff_gear	Flap-hinge moment coefficients due to gearing.	alpha, delta, mach, alt
ttab_def	Trim-tab deflections for zero stick force.	alpha, delta, mach, alt

#### High-Lift and Control Fields Available for Trim for the 1976 Version (File Type 6)

Field	Matrix of...	Function of...
cl_utrim	Untrimmed lift coefficients, which are defined positive for an up-acting load.	alpha, mach, alt
cd_utrim	Untrimmed drag coefficients, which are defined positive for an aft-acting load.	alpha, mach, alt
cm_utrim	Untrimmed pitching-moment coefficients, which are defined positive for a nose-up rotation.	alpha, mach, alt
delt_trim	Trimmed control-surface streamwise deflection angles.	alpha, mach, alt

Field	Matrix of...	Function of...
dcl_trim	Trimmed incremental lift coefficients in the linear-lift angle of attack range due to deflection of control surface.	alpha, mach, alt
dclmax_trim	Trimmed incremental maximum lift coefficients.	alpha, mach, alt
dcdi_trim	Trimmed incremental induced drag coefficients due to flap deflection.	alpha, mach, alt
dcdmin_trim	Trimmed incremental minimum drag coefficients due to control or flap deflection.	alpha, mach, alt
cha_trim	Trimmed control-surface hinge-moment derivatives due to angle of attack.	alpha, mach, alt
chd_trim	Trimmed control-surface hinge-moment derivatives due to control deflection.	alpha, mach, alt
cl_tailutrim	Untrimmed stabilizer lift coefficients, which are defined positive for an up-acting load.	alpha, mach, alt
cd_tailutrim	Untrimmed stabilizer drag coefficients, which are defined positive for an aft-acting load.	alpha, mach, alt
cm_tailutrim	Untrimmed stabilizer pitching-moment coefficients, which are defined positive for a nose-up rotation.	alpha, mach, alt
hm_tailutrim	Untrimmed stabilizer hinge-moment coefficients, which are defined positive for a stabilizer rotation with leading edge up and trailing edge down.	alpha, mach, alt
aliht_tailtrim	Stabilizer incidence required to trim.	alpha, mach, alt
cl_tailtrim	Trimmed stabilizer lift coefficients, which are defined positive for an up-acting load.	alpha, mach, alt
cd_tailtrim	Trimmed stabilizer drag coefficients, which are defined positive for an aft-acting load.	alpha, mach, alt
cm_tailtrim	Trimmed stabilizer pitching-moment coefficients, which are defined positive for a nose-up rotation.	alpha, mach, alt

Field	Matrix of...	Function of...
hm_tailtrim	Trimmed stabilizer hinge-moment coefficients, which are defined positive for a stabilizer rotation with leading edge up and trailing edge down.	alpha, mach, alt
cl_trimi	Lift coefficients at trim incidence. These coefficients are defined positive for an up-acting load.	alpha, mach, alt
cd_trimi	Drag coefficients at trim incidence. These coefficients are defined positive for an aft-acting load.	alpha, mach, alt

#### Transverse Jet Control Fields for the 1976 Version (File Type 6)

Field	Description	Stored with Indices of...
time	Matrix of times.	mach, alt, alpha
ctrlfrfc	Matrix of control forces.	mach, alt, alpha
locmach	Matrix of local Mach numbers.	mach, alt, alpha
reynum	Matrix of Reynolds numbers.	mach, alt, alpha
locpres	Matrix of local pressures.	mach, alt, alpha
dynpres	Matrix of dynamic pressures.	mach, alt, alpha
blayer	Cell array of character vectors containing the state of the boundary layer.	mach, alt, alpha
ctrlcoeff	Matrix of control force coefficients.	mach, alt, alpha
corrcoeff	Matrix of corrected force coefficients.	mach, alt, alpha
sonicamp	Matrix of sonic amplification factors.	mach, alt, alpha
ampfact	Matrix of amplification factors.	mach, alt, alpha
vacthr	Matrix of vacuum thrusts.	mach, alt, alpha
minpres	Matrix of minimum pressure ratios.	mach, alt, alpha
minjet	Matrix of minimum jet pressures.	mach, alt, alpha
jetpres	Matrix of jet pressures.	mach, alt, alpha
massflow	Matrix of mass flow rates.	mach, alt, alpha

Field	Description	Stored with Indices of...
propelwt	Matrix of propellant weights.	mach, alt, alpha

**Hypersonic Fields for the 1976 Version (File Type 6)**

Field	Matrix of...	Stored with Indices of...
df_normal	Increments in normal force per spanwise foot of control.	alpha, delta, mach
df_axial	Increments in axial force per spanwise foot of control.	alpha, delta, mach
cm_normal	Increments in pitching moment due to normal force per spanwise foot of control.	alpha, delta, mach
cm_axial	Increments in pitching moment due to axial force per spanwise foot of control.	alpha, delta, mach
cp_normal	Center of pressure locations of normal force.	alpha, delta, mach
cp_axial	Center of pressure locations of axial force.	alpha, delta, mach

**Auxiliary and Partial Fields Available for the 1976 Version (File Type 6)**

Field	Matrix of...	Stored with Indices of...
wetarea_b	Body wetted area.	mach, alt, number of runs
xcg_b	Longitudinal locations of the center of gravity.	mach, alt, number of runs (normally 1, 2 for hypers = true)
zcg_b	Vertical locations of the center of gravity.	mach, alt, number of runs (normally 1, 2 for hypers = true)
basearea_b	Body base area.	mach, alt, number of runs (normally 1, 2 for hypers = true)
cd0_b	Body zero lift drags.	mach, alt, number of runs (normally 1, 2 for hypers = true)
basedrag_b	Body base drags.	mach, alt, number of runs (normally 1, 2 for hypers = true)
fricdrag_b	Body friction drags.	mach, alt, number of runs (normally 1, 2 for hypers = true)
presdrag_b	Body pressure drags.	mach, alt, number of runs (normally 1, 2 for hypers = true)



Field	Matrix of...	Stored with Indices of...
lemac	Leading edge mean aerodynamic chords.	mach, alt
sidewash	sidewash	mach, alt
hiv_b_w	iv-b(w)	alpha, mach, alt
hiv_w_h	iv-w(h)	alpha, mach, alt
hiv_b_h	iv-b(h)	alpha, mach, alt
gamma	$\gamma * 2 * \pi * \alpha * v * r$	alpha, mach, alt
gamma2pialpvr	$\gamma * (2 * \pi * \alpha * v * r) * t$	alpha, mach, alt
clpgammacl0	clp(gamma=cl=0)	mach, alt
clpgammaclp	clp(gamma)/cl (gamma=0)	mach, alt
cnptheta	cnp/theta	mach, alt
cypgamma	cyp/gamma	mach, alt
cypcl	cyp/cl (cl=0)	mach, alt
clbgamma	clb/gamma	mach, alt
cmotheta_w	(cmo/theta)_w	mach, alt
cmotheta_h	(cmo/theta)_h	mach, alt
espeff	(epsoln)eff	alpha, mach, and alt
despdalpeff	d(epsoln)/d(alpha) eff	alpha, mach, alt
dragdiv	drag divergence mach number	mach, alt
cd0mach	Four Mach numbers for the zero lift drag.	index, mach, alt
cd0	Four zero lift drags.	index, mach, alt
clbclmfb_****	(clb/cl)mfb, where **** is either wb (wing-body) or bht (body-horizontal tail).	mach, alt.
cnam14_****	(cna)_m=1.4, where **** is either wb (wing-body) or bht (body-horizontal tail).	mach,alt
area_*_**	Areas, where * is either w (wing), ht (horizontal tail), vt (vertical tail),	mach, alt, number of runs (normally 1, 2 for hypers = true)

Field	Matrix of...	Stored with Indices of...
	or <b>vf</b> (ventral fin) and <b>**</b> is either <b>tt</b> (total theoretical), <b>ti</b> (theoretical inboard), <b>te</b> (total exposed), <b>ei</b> (exposed inboard), or <b>o</b> (outboard).	
<b>taperratio_ *_ **</b>	Taper ratios, where <b>*</b> is either <b>w</b> (wing), <b>ht</b> (horizontal tail), <b>vt</b> (vertical tail), or <b>vf</b> (ventral fin) and <b>**</b> is either <b>tt</b> (total theoretical), <b>ti</b> (theoretical inboard), <b>te</b> (total exposed), <b>ei</b> (exposed inboard), or <b>o</b> (outboard).	<b>mach</b> , <b>alt</b> , number of runs (normally 1, 2 for <b>hypers = true</b> )
<b>aspectratio_ *_ **</b>	Aspect ratios, where <b>*</b> is either <b>w</b> (wing), <b>ht</b> (horizontal tail), <b>vt</b> (vertical tail), or <b>vf</b> (ventral fin) and <b>**</b> is either <b>tt</b> (total theoretical), <b>ti</b> (theoretical inboard), <b>te</b> (total exposed), <b>ei</b> (exposed inboard), or <b>o</b> (outboard).	<b>mach</b> , <b>alt</b> , number of runs (normally 1, 2 for <b>hypers = true</b> )
<b>qcsweep_ *_ **</b>	Quarter chord sweeps, where <b>*</b> is either <b>w</b> (wing), <b>ht</b> (horizontal tail), <b>vt</b> (vertical tail), or <b>vf</b> (ventral fin) and <b>**</b> is either <b>tt</b> (total theoretical), <b>ti</b> (theoretical inboard), <b>te</b> (total exposed), <b>ei</b> (exposed inboard), or <b>o</b> (outboard).	<b>mach</b> , <b>alt</b> , number of runs (normally 1, 2 for <b>hypers = true</b> )
<b>mac_ *_ **</b>	Mean aerodynamic chords, where <b>*</b> is either <b>w</b> (wing), <b>ht</b> (horizontal tail), <b>vt</b> (vertical tail), or <b>vf</b> (ventral fin) and <b>**</b> is either <b>tt</b> (total theoretical), <b>ti</b> (theoretical inboard), <b>te</b> (total exposed), <b>ei</b> (exposed inboard), or <b>o</b> (outboard).	<b>mach</b> , <b>alt</b> , number of runs (normally 1, 2 for <b>hypers = true</b> )
<b>qcmac_ *_ **</b>	Quarter chord $\chi$ ( <b>mac</b> ), where <b>*</b> is either <b>w</b> (wing), <b>ht</b> (horizontal tail), <b>vt</b> (vertical tail), or <b>vf</b> (ventral fin) and <b>**</b> is either <b>tt</b> (total theoretical),	<b>mach</b> , <b>alt</b> , number of runs (normally 1, 2 for <b>hypers = true</b> )

Field	Matrix of...	Stored with Indices of...
	<b>ti</b> (theoretical inboard), <b>te</b> (total exposed), <b>ei</b> (exposed inboard), or <b>o</b> (outboard).	
<b>y</b> mac_*_**	<b>y</b> (mac), where * is either <b>w</b> (wing), <b>ht</b> (horizontal tail), <b>vt</b> (vertical tail), or <b>vf</b> (ventral fin) and ** is either <b>tt</b> (total theoretical), <b>ti</b> (theoretical inboard), <b>te</b> (total exposed), <b>ei</b> (exposed inboard), or <b>o</b> (outboard).	<b>mach</b> , <b>alt</b> , number of runs (normally 1, 2 for <b>hypers = true</b> )
<b>cd</b> 0_*_**	Zero lift drags, where * is either <b>w</b> (wing), <b>ht</b> (horizontal tail), <b>vt</b> (vertical tail), or <b>vf</b> (ventral fin) and ** is either <b>tt</b> (total theoretical), <b>ti</b> (theoretical inboard), <b>te</b> (total exposed), <b>ei</b> (exposed inboard), or <b>o</b> (outboard).	<b>mach</b> , <b>alt</b> , number of runs (normally 1, 2 for <b>hypers = true</b> )
<b>fric</b> coeff_*_**	Friction coefficients, where * is either <b>w</b> (wing), <b>ht</b> (horizontal tail), <b>vt</b> (vertical tail), or <b>vf</b> (ventral fin) and ** is either <b>tt</b> (total theoretical), <b>ti</b> (theoretical inboard), <b>te</b> (total exposed), <b>ei</b> (exposed inboard), or <b>o</b> (outboard).	<b>mach</b> , <b>alt</b> , number of runs (normally 1, 2 for <b>hypers = true</b> )
<b>cla</b> _b_***	<b>cla-b</b> (***), where *** is either <b>w</b> (wing) or <b>ht</b> (stabilizer).	<b>mach</b> , <b>alt</b> , number of runs (normally 1, 2 for <b>hypers = true</b> )
<b>cla</b> _***_b	<b>cla-***</b> (b), where *** is either <b>w</b> (wing) or <b>ht</b> (stabilizer).	<b>mach</b> , <b>alt</b> , number of runs (normally 1, 2 for <b>hypers = true</b> )
<b>k</b> _b_***	<b>k-b</b> (***), where *** is either <b>w</b> (wing) or <b>ht</b> (stabilizer).	<b>mach</b> , <b>alt</b> , number of runs (normally 1, 2 for <b>hypers = true</b> )
<b>k</b> _***_b	<b>k-***</b> (b), where *** is either <b>w</b> (wing) or <b>ht</b> (stabilizer).	<b>mach</b> , <b>alt</b> , number of runs (normally 1, 2 for <b>hypers = true</b> )
<b>xacc</b> _b_***	<b>xac/c-b</b> (***), where *** is either <b>w</b> (wing) or <b>ht</b> (stabilizer).	<b>mach</b> , <b>alt</b> , number of runs (normally 1, 2 for <b>hypers = true</b> )

Field	Matrix of...	Stored with Indices of...
cdlc12_***	$cdl/cl^2$ , where *** is either w (wing) or ht (stabilizer).	mach, alt
clbc1_***	$clb/cl$ , where *** is either w (wing) or ht (stabilizer).	mach, alt
fmach0_***	Force break Mach numbers with zero sweep, where *** is either w (wing) or ht (stabilizer).	mach, alt
fmach_***	Force break Mach numbers with sweep, where *** is either w (wing) or ht (stabilizer).	mach, alt
macha_***	$mach(a)$ , where *** is either w (wing) or ht (stabilizer).	mach, alt
machb_***	$mach(b)$ , where *** is either w (wing) or ht (stabilizer).	mach, alt
claa_***	$cla(a)$ , where *** is either w (wing) or ht (stabilizer).	mach, alt
clab_***	$cla(b)$ , where *** is either w (wing) or ht (stabilizer).	mach, alt
clbm06_***	$(clb/cl)^m=0.6$ , where *** is either w (wing) or ht (stabilizer).	mach, alt
clbm14_***	$(clb/cl)^m=1.4$ , where *** is either w (wing) or ht (stabilizer).	mach, alt
clalpmach_***	Five Mach numbers for the lift curve slope, where *** is either w (wing) or ht (stabilizer).	index, mach, alt
clalp_***	Five lift-curve slope values, where *** is either w (wing) or ht (stabilizer).	index, mach, alt

## Fields for 1999 Version (File Type 6)

### Common Fields for the 1999 Version (File Type 6)

Field	Description	Default
case	Character vector containing the case ID.	[ ]
mach	Array of Mach numbers.	[ ]
alt	Array of altitudes.	[ ]
alpha	Array of angles of attack.	[ ]
nmach	Number of Mach numbers.	0
nalt	Number of altitudes.	1
nalpha	Number of angles of attack.	0
rnnub	Array of Reynolds numbers.	[ ]
beta	Scalar containing sideslip angle.	0
phi	Scalar containing aerodynamic roll angle.	0
loop	Scalar denoting the type of looping performed to generate the DATCOM file. When <code>loop</code> is 1, <code>mach</code> and <code>alt</code> are varied together. The only loop option for the 1999 version of DATCOM is <code>loop</code> is equal to 1.	1
sref	Scalar denoting the reference area for the case.	[ ]
cbar	Scalar denoting the longitudinal reference length.	[ ]
blref	Scalar denoting the lateral reference length.	[ ]
dim	Character vector denoting the specified system of units for the case.	'ft'
deriv	Character vector denoting the specified angle units for the case.	'deg'
save	Logical denoting whether the input values for this case are used in the next case.	false
stype	Scalar denoting the type of asymmetric flap for the case.	[ ]
trim	Logical denoting the reading of trim data for the case. When trim runs are read, this value is set to <code>true</code> .	false

Field	Description	Default
damp	Logical denoting the reading of dynamic derivative data for the case. When dynamic derivative runs are read, this value is set to <b>true</b> .	false
build	Scalar denoting the reading of build data for the case. When build runs are read, this value is set to the number of build runs depending on the vehicle configuration.	1
part	Logical denoting the reading of partial data for the case. When partial runs are written for each Mach number, this value is set to <b>true</b> .	false
hypeff	Logical denoting the reading of hypersonic data for the case. When hypersonic data is read, this value is set to <b>true</b> .	false
ngh	Scalar denoting the number of ground altitudes.	0
nolat	Logical denoting the calculation of the lateral-direction derivatives is inhibited.	false
config	Structure of logicals and structures detailing the case configuration and fin deflections.	<pre> config.body = false config.fin1.avail = false; config.fin1.npanel = []; config.fin1.delta = []; config.fin2.avail = false; config.fin2.npanel = []; config.fin2.delta = []; config.fin3.avail = false; config.fin3.npanel = []; config.fin3.delta = []; config.fin4.avail = false; config.fin4.npanel = []; config.fin4.delta = []; </pre>
version	Version of DATCOM file.	1999

**Static Longitude and Lateral Stability Fields Available for the 1999 Version (File Type 6)**

Field	Matrix of...	Function of...
cd	Drag coefficients, which are defined positive for an aft-acting load.	alpha, mach, alt, build
cl	Lift coefficients, which are defined positive for an up-acting load.	alpha, mach, alt, build
cm	Pitching-moment coefficients, which are defined positive for a nose-up rotation.	alpha, machalt, build
cn	Normal-force coefficients, which are defined positive for a normal force in the +Z direction.	alpha, mach, alt, build
ca	Axial-force coefficients, which are defined positive for a normal force in the +X direction.	alpha, mach, alt, build
xcp	Distances between moment reference center and the center of pressure divided by the longitudinal reference length. These distances are defined positive for a location forward of the center of gravity.	alpha, mach, alt, build
cna	Derivatives of normal-force coefficients relative to alpha.	alpha, mach, alt, build
cma	Derivatives of pitching-moment coefficients relative to alpha.	alpha, mach, alt, build
cyb	Derivatives of side-force coefficients relative to sideslip angle.	alpha, mach, alt, build
cnb	Derivatives of yawing-moment coefficients relative to sideslip angle.	alpha, mach, alt, build
clb	Derivatives of rolling-moment coefficients relative to sideslip angle.	alpha, mach, alt, build
clod	Ratios of lift coefficient to drag coefficient.	alpha, mach, alt, build
cy	Side-force coefficients.	alpha, mach, alt, build
cln	Yawing-moment coefficient in body-axis.	alpha, mach, alt, build
cll	Rolling-moment coefficient in body-axis.	alpha, mach, alt, build

#### Dynamic Derivative Fields for the 1999 Version (File Type 6)

Field	Matrix of...	Function of...
cnq	Normal-force derivatives due to pitch rate.	alpha, mach, alt, build

Field	Matrix of...	Function of...
cmq	Pitching-moment derivatives due to pitch rate.	alpha, mach, alt, build
caq	Axial-force derivatives due to pitch rate.	alpha, mach, alt, build
cnad	Normal-force derivatives due to rate of angle of attack.	alpha, mach, alt, build
cmad	Pitching-moment derivatives due to rate of angle of attack.	alpha, mach, alt, build
clp	Rolling-moment derivatives due to roll rate.	alpha, mach, alt, build
cyp	Lateral force derivatives due to roll rate.	alpha, mach, alt, build
cnp	Yawing-moment derivatives due to roll rate.	alpha, mach, alt, build
cnr	Yawing-moment derivatives due to yaw rate.	alpha, mach, alt, build
clr	Rolling-moment derivatives due to yaw rate.	alpha, mach, alt, build
cyr	Side force derivatives due to yaw rate.	alpha, mach, alt, build

### Fields for 2007, 2008, 2011, and 2014 Versions (File Type 6)

#### Common Fields for the 2007, 2008, 2011, and 2014 Versions (File Type 6)

Field	Description	Default
case	Character vector containing the case ID.	[ ]
mach	Array of Mach numbers.	[ ]
alt	Array of altitudes.	[ ]
alpha	Array of angles of attack.	[ ]
nmach	Number of Mach numbers.	0
nalt	Number of altitudes.	1
nalpha	Number of angles of attack.	0
rnnub	Array of Reynolds numbers.	[ ]
beta	Scalar containing sideslip angle.	0



Field	Description	Default
	<b>Note:</b> This value does not appear correctly for the 2014 version. It always displays 0.	
phi	Scalar containing aerodynamic roll angle.	0
loop	Scalar denoting the type of looping performed to generate the DATCOM file. When <code>loop</code> is 1, <code>mach</code> and <code>alt</code> are varied together. The only loop option for the 2007 version of DATCOM is <code>loop</code> , equal to 1.	1
sref	Scalar denoting the reference area for the case.	[ ]
cbar	Scalar denoting the longitudinal reference length.	[ ]
blref	Scalar denoting the lateral reference length.	[ ]
dim	Character vector denoting the specified system of units for the case.	'ft'
deriv	Character vector denoting the specified angle units for the case.	'deg'
save	Logical denoting whether the input values for this case are used in the next case.	false
stype	Scalar denoting the type of asymmetric flap for the case.	[ ]
trim	Logical denoting the reading of trim data for the case. When trim runs are read, this value is set to <code>true</code> .	false
damp	Logical denoting the reading of dynamic derivative data for the case. When dynamic derivative runs are read, this value is set to <code>true</code> .	false
build	Scalar denoting the reading of build data for the case. When build runs are read, this value is set to the number of build runs depending on the vehicle configuration.	1

Field	Description	Default
part	Logical denoting the reading of partial data for the case. When partial runs are written for each Mach number, this value is set to <b>true</b> .	false
hypreff	Logical denoting the reading of hypersonic data for the case. When hypersonic data is read, this value is set to <b>true</b> .	false
ngh	Scalar denoting the number of ground altitudes.	0
nolat	Logical denoting the calculation of the lateral-direction derivatives is inhibited.	false
config	Structure of logicals and structures detailing the case configuration and fin deflections.	<pre> config.body = false; config.fin1.avail = false; config.fin1.npanel = []; config.fin1.delta = []; config.fin2.avail = false; config.fin2.npanel = []; config.fin2.delta = []; config.fin3.avail = false; config.fin3.npanel = []; config.fin3.delta = []; config.fin4.avail = false; config.fin4.npanel = []; config.fin4.delta = [];                     </pre>
nolat_ - namelist	Logical denoting the calculation of the lateral-direction derivatives is inhibited in the DATCOM input case.	false
version	Version of DATCOM file.	2007

**Static Longitude and Lateral Stability Fields Available for the 2007, 2008, 2011, and 2014 Versions (File Type 6)**

Field	Matrix of...	Function of...
cd	Drag coefficients, which are defined positive for an aft-acting load.	alpha, mach, alt, build
cl	Lift coefficients, which are defined positive for an up-acting load.	alpha, mach, alt, build

Field	Matrix of...	Function of...
cm	Pitching-moment coefficients, which are defined positive for a nose-up rotation.	alpha, mach, alt, build
cn	Normal-force coefficients, which are defined positive for a normal force in the +Z direction.	alpha, mach, alt, build
ca	Axial-force coefficients, which are defined positive for a normal force in the +X direction.	alpha, mach, alt, build
xcp	Distances between moment reference center and the center of pressure divided by the longitudinal reference length. These distances are defined positive for a location forward of the center of gravity.	alpha, mach, alt, build
cna	Derivatives of normal-force coefficients relative to alpha.	alpha, mach, alt, build
cma	Derivatives of pitching-moment coefficients relative to alpha.	alpha, mach, alt, build
cyb	Derivatives of side-force coefficients relative to sideslip angle.	alpha, mach, alt, build
cnb	Derivatives of yawing-moment coefficients relative to sideslip angle.	alpha, mach, alt, build
clb	Derivatives of rolling-moment coefficients relative to sideslip angle.	alpha, mach, alt, build
clod	Ratios of lift coefficient to drag coefficient.	alpha, mach, alt, build
cy	Side-force coefficients.	alpha, mach, alt, build
cln	Yawing-moment coefficient in body-axis.	alpha, mach, alt, build
cll	Rolling-moment coefficient in body-axis.	alpha, mach, alt, build

#### Dynamic Derivative Fields for the 2007, 2008, 2011, and 2014 Versions (File Type 6)

Field	Matrix of...	Function of...
cnq	Normal-force derivatives due to pitch rate.	alpha, mach, alt, build
cmq	Pitching-moment derivatives due to pitch rate.	alpha, mach, alt, build
caq	Axial-force derivatives due to pitch rate.	alpha, mach, alt, build

Field	Matrix of...	Function of...
cnad	Normal-force derivatives due to rate of angle of attack.	alpha, mach, alt, build
cmad	Pitching-moment derivatives due to rate of angle of attack.	alpha, mach, alt, build
clp	Rolling-moment derivatives due to roll rate.	alpha, mach, alt, build
cyp	Lateral-force derivatives due to roll rate.	alpha, mach, alt, build
cnp	Yawing-moment derivatives due to roll rate.	alpha, mach, alt, build
cnr	Yawing-moment derivatives due to yaw rate.	alpha, mach, alt, build
clr	Rolling-moment derivatives due to yaw rate	alpha, mach, alt, build
cyr	Side-force derivatives due to yaw rate.	alpha, mach, alt, build

### Fields for 2007, 2008, 2011, and 2014 Versions (File Type 21)

For 2008, 2011, and 2014, the version is 2008. There are no discernible differences in the outputs of these versions.

### Common Fields for the 2007, 2008, 2011, and 2014 Versions (File Type 21)

Field	Description	Default
mach	Array of Mach numbers.	[ ]
alt	Array of altitudes.	[ ]
alpha	Array of angles of attack.	[ ]
nalpha	Number of angles of attack.	0
beta	Scalar containing sideslip angle.  <b>Note:</b> This value does not appear correctly for the 2014 version. It always displays 0.	0
total_col	Scalar denoting the type of looping performed to generate the DATCOM file. When loop is 1, mach and alt are varied together. The only loop option for	[ ]

Field	Description	Default
	the 2007, 2008, 2011, and 2014 versions of DATCOM is <code>loop</code> equal to 1.	
<code>deriv_col</code>	Logical denoting the calculation of the lateral-direction derivatives is inhibited.	0
<code>config</code>	Structure of logicals and structures detailing the case configuration and fin deflections.	<code>config.fin1.delta = zeros(1,8);</code> <code>config.fin2.delta = zeros(1,8);</code> <code>config.fin3.delta = zeros(1,8);</code> <code>config.fin4.delta = zeros(1,8);</code>
<code>version</code>	Version of DATCOM file.	2007

#### Static Longitude and Lateral Stability Fields Available for the 2007, 2008, 2011, and 2014 Versions (File Type 21)

Field	Matrix of...	Function of...
<code>cn</code>	Normal-force coefficients, which are defined positive for a normal force in the +Z direction.	<code>alpha</code> , <code>mach</code> , <code>alt</code> , <code>beta</code> , <code>config.fin1.delta</code> , <code>config.fin2.delta</code> , <code>config.fin3.delta</code> , <code>config.fin4.delta</code>
<code>cm</code>	Pitching-moment coefficients, which are defined positive for a nose-up rotation.	<code>alpha</code> , <code>mach</code> , <code>alt</code> , <code>beta</code> , <code>config.fin1.delta</code> , <code>config.fin2.delta</code> , <code>config.fin3.delta</code> , <code>config.fin4.delta</code>
<code>ca</code>	Axial-force coefficients, which are defined positive for a normal force in the +X direction.	<code>alpha</code> , <code>mach</code> , <code>alt</code> , <code>beta</code> , <code>config.fin1.delta</code> , <code>config.fin2.delta</code> , <code>config.fin3.delta</code> , <code>config.fin4.delta</code>
<code>cy</code>	Side-force coefficients.	<code>alpha</code> , <code>mach</code> , <code>alt</code> , <code>beta</code> , <code>config.fin1.delta</code> , <code>config.fin2.delta</code> , <code>config.fin3.delta</code> , <code>config.fin4.delta</code>

Field	Matrix of...	Function of...
c1n	Yawing-moment coefficient in body-axis.	alpha, mach, alt, beta, config.fin1.delta, config.fin2.delta, config.fin3.delta, config.fin4.delta
c1l	Rolling-moment coefficient in body-axis.	alpha, mach, alt, beta, config.fin1.delta, config.fin2.delta, config.fin3.delta, config.fin4.delta

**Dynamic Derivative Fields for the 2007, 2008, 2011, and 2014 Versions (File Type 21)**

Field	Matrix of...	Function of...
cnad	Normal-force derivatives due to rate of angle of attack.	alpha, mach, alt, beta, config.fin1.delta, config.fin2.delta, config.fin3.delta, config.fin4.delta
cmad	Pitching-moment derivatives due to rate of angle of attack.	alpha, mach, alt, beta, config.fin1.delta, config.fin2.delta, config.fin3.delta, config.fin4.delta
cnq	Normal-force derivatives due to pitch rate.	alpha, mach, alt, beta, config.fin1.delta, config.fin2.delta, config.fin3.delta, config.fin4.delta
cmq	Pitching-moment derivatives due to pitch rate.	alpha, mach, alt, beta, config.fin1.delta, config.fin2.delta, config.fin3.delta, config.fin4.delta
caq	Axial-force derivatives due to pitch rate.	alpha, mach, alt, beta, config.fin1.delta,

Field	Matrix of...	Function of...
		config.fin2.delta, config.fin3.delta, config.fin4.delta
cyq	Side-force due to pitch rate.	alpha, mach, alt, beta, config.fin1.delta, config.fin2.delta, config.fin3.delta, config.fin4.delta
clnq	Yawing-moment due to pitch rate.	alpha, mach, alt, beta, config.fin1.delta, config.fin2.delta, config.fin3.delta, config.fin4.delta
cllq	Rolling-moment due to pitch rate.	alpha, mach, alt, beta, config.fin1.delta, config.fin2.delta, config.fin3.delta, config.fin4.delta
cnp	Yawing-moment derivatives due to roll rate.	alpha, mach, alt, beta, config.fin1.delta, config.fin2.delta, config.fin3.delta, config.fin4.delta
cap	Axial-force due to roll rate.	alpha, mach, alt, beta, config.fin1.delta, config.fin2.delta, config.fin3.delta, config.fin4.delta
cyp	Lateral-force derivatives due to roll rate.	alpha, mach, alt, beta, config.fin1.delta, config.fin2.delta, config.fin3.delta, config.fin4.delta
clnp	Yawing-moment due to roll rate.	alpha, mach, alt, beta, config.fin1.delta,

Field	Matrix of...	Function of...
		config.fin2.delta, config.fin3.delta, config.fin4.delta
c11p	Rolling-moment due to roll rate.	alpha, mach, alt, beta, config.fin1.delta, config.fin2.delta, config.fin3.delta, config.fin4.delta
cnr	Yawing-moment derivatives due to yaw rate.	alpha, mach, alt, beta, config.fin1.delta, config.fin2.delta, config.fin3.delta, config.fin4.delta
car	Axial-force due to yaw rate.	alpha, mach, alt, beta, config.fin1.delta, config.fin2.delta, config.fin3.delta, config.fin4.delta
cyr	Side-force derivatives due to yaw rate.	alpha, mach, alt, beta, config.fin1.delta, config.fin2.delta, config.fin3.delta, config.fin4.delta
clnr	Yawing-moment due to yaw rate.	alpha, mach, alt, beta, config.fin1.delta, config.fin2.delta, config.fin3.delta, config.fin4.delta
c11r	Rolling-moment due to yaw rate.	alpha, mach, alt, beta, config.fin1.delta, config.fin2.delta, config.fin3.delta, config.fin4.delta



## Fields for 2008, 2011, and 2014 Version (File Type 42)

### Fields for the 2008, 2011, and 2014 Version (File Type 42)

Field	Description	Default
case	Character vector containing the case ID.	[ ]
totalCol	Scalar containing number of columns of data in file.	[ ]
mach	Array of Mach numbers.	[ ]
alt	Array of altitudes.	[ ]
alpha	Array of angles of attack.	[ ]
nmach	Number of Mach numbers.	0
nalpha	Number of angles of attack.	0
rnnub	Array of Reynolds numbers.	[ ]
q	Dynamic pressure.	[ ]
beta	Scalar containing sideslip angle.  <b>Note:</b> This value does not appear correctly for the 2014 version. It always displays 0.	0
phi	Scalar containing aerodynamic roll angle.	0
sref	Scalar denoting the reference area for the case.	[ ]
cbar	Scalar denoting the longitudinal reference length.	[ ]
blref	Scalar denoting the lateral reference length.	[ ]
xcg	Distance from nose to center of gravity.	[ ]
xmrp	Distance from nose to center of gravity, measured in calibers.	[ ]
deriv	Character vector denoting the specified angle units for the case.	'deg'

Field	Description	Default
trim	Logical denoting the reading of trim data for the case. When trim runs are read, this value is set to <b>true</b> .	false
damp	Logical denoting the reading of dynamic derivative data for the case. When dynamic derivative runs are read, this value is set to <b>true</b> .	false
build	Scalar denoting the reading of partial data for the case. This value is set to the number of partial runs depending on the vehicle configuration.	1
part	Logical denoting the reading of partial data for the case. When partial runs are written for each Mach number, this value is set to <b>true</b> .	false
nolat	Logical denoting the calculation of the lateral-direction derivatives is inhibited.	true
config	Structure of logicals and structures detailing the case configuration and fin deflections.	<pre> config.body = false; config.fin1.avail = false; config.fin1.npanel = []; config.fin1.delta = []; config.fin2.avail = false; config.fin2.npanel = []; config.fin2.delta = []; config.fin3.avail = false; config.fin3.npanel = []; config.fin3.delta = []; config.fin4.avail = false; config.fin4.npanel = [];                     </pre>
version	Version of DATCOM file.	2008

**Static Longitude and Lateral Stability Fields Available for the 2008, 2011, and 2014 Versions (File Type 42)**

Field	Matrix of...	Function of...
delta	Trim deflection angles.	alpha, mach
cd	Drag coefficients, which are defined positive for an aft-acting load.	alpha, mach, build

Field	Matrix of...	Function of...
c1	Lift coefficients, which are defined positive for an up-acting load.	alpha, mach, build
cm	Pitching-moment coefficients, which are defined positive for a nose-up rotation.	alpha, mach, build
cn	Normal-force coefficients, which are defined positive for a normal force in the +Z direction.	alpha, mach, build
ca	Axial-force coefficients, which are defined positive for a normal force in the +X direction.	alpha, mach, build
caZeroBase	Axial-force coefficient with no base drag included.	alpha, mach, build
caFullBase	Axial-force coefficient with full base drag included.	alpha, mach, build
xcp	Distance from nose to center of pressure.	alpha, mach, build
cna	Derivatives of normal-force coefficients relative to alpha.	alpha, mach, build
cma	Derivatives of pitching-moment coefficients relative to alpha.	alpha, mach, build
cyb	Derivatives of side-force coefficients relative to sideslip angle.	alpha, mach, build
cnb	Derivatives of yawing-moment coefficients relative to sideslip angle.	alpha, mach, build
clb	Derivatives of rolling-moment coefficients relative to sideslip angle.	alpha, mach, build
clod	Ratios of lift coefficient to drag coefficient.	alpha, mach, build
cy	Side-force coefficient.	alpha, mach, build
cln	Yawing-moment coefficient.	alpha, mach, build
cll	Rolling-moment coefficient.	alpha, mach, build

#### Dynamic Derivative Fields for the 2008, 2011, and 2014 Version (File Type 42)

Field	Matrix of...	Function of...
cnq	Normal-force derivatives due to pitch rate.	alpha, mach, alt, build
cmq	Pitching-moment derivatives due to pitch rate.	alpha, mach, alt, build
caq	Axial-force derivatives due to pitch rate.	alpha, mach, alt, build
cnad	Normal-force derivatives due to rate of angle of attack.	alpha, mach, alt, build
cmad	Pitching-moment derivatives due to rate of angle of attack.	alpha, mach, alt, build
cyq	Lateral-force derivatives due to pitch rate.	alpha, mach, alt, build
clnq	Yawing-moment derivatives due to pitch rate.	alpha, mach, alt, build
cllq	Rolling-moment derivatives due to pitch rate.	alpha, mach, alt, build
cyr	Side-force derivatives due to yaw rate.	alpha, mach, alt, build
clnr	Yawing-moment derivatives due to yaw rate.	alpha, mach, alt, build
cllr	Rolling-moment derivatives due to yaw rate.	alpha, mach, alt, build
cyp	Lateral-force derivatives due to roll rate.	alpha, mach, alt, build
clnp	Yawing-moment derivatives due to roll rate.	alpha, mach, alt, build
cllp	Rolling-moment derivatives due to roll rate.	alpha, mach, alt, build
cnp	Normal-force derivatives due to roll rate.	alpha, mach, alt, build
cmp	Pitching-moment derivatives due to roll rate.	alpha, mach, alt, build
cap	Axial-force derivatives due to roll rate.	alpha, mach, alt, build
cnr	Normal-force derivatives due to yaw rate.	alpha, mach, alt, build
cmr	Pitching-moment derivatives due to roll rate.	alpha, mach, alt, build
car	Axial-force derivatives due to yaw rate.	alpha, mach, alt, build

## Examples

Read the 1976 version Digital DATCOM output file `astdatcom.out`:

```
aero = datcomimport('astdatcom.out')
```

Read the 1976 Digital DATCOM output file `astdatcom.out` using zeros to replace data points where no DATCOM methods exist and displaying status information in the MATLAB Command Window:

```
usenan = false;  
aero = datcomimport('astdatcom.out', usenan, 1 )
```

## Assumptions and Limitations

The operational limitations of the 1976 version DATCOM apply to the data contained in AERO. For more information on DATCOM limitations, see [1], section 2.4.5.

USAF Digital DATCOM data for wing section, horizontal tail section, vertical tail section, and ventral fin section are not read.

## References

1. AFFDL-TR-79-3032: *The USAF Stability and Control DATCOM*, Volume 1, User's Manual
2. AFRL-VA-WP-TR-1998-3009: *MISSILE DATCOM*, User's Manual – 1997 FORTRAN 90 Revision
3. AFRL-RB-WP-TR-2009-3015: *MISSILE DATCOM*, User's Manual – 2008 Revision
4. AFRL-RB-WP-TR-2011-3071: *MISSILE DATCOM*, User's Manual – 2011 Revision
5. AFRL-RQ-WP-TR-2014-3999: *MISSILE DATCOM*, Users Manual – 2014 Revision

**Introduced in R2006b**

## dcm2alphabeta

Convert direction cosine matrix to angle of attack and sideslip angle

### Syntax

```
[a b] = dcm2alphabeta(n)
```

### Description

[a b] = dcm2alphabeta(n) calculates the angle of attack and sideslip angle, **a** and **b**, for a given direction cosine matrix, **n**. **n** is a 3-by-3-by-*m* matrix containing *m* orthogonal direction cosine matrices. **a** is an *m* array of angles of attack. **b** is an *m* array of sideslip angles. **n** performs the coordinate transformation of a vector in body-axes into a vector in wind-axes. Angles of attack and sideslip angles are output in radians.

### Examples

Determine the angle of attack and sideslip angle from direction cosine matrix:

```
dcm = [ 0.8926    0.1736    0.4162; ...  
       -0.1574    0.9848   -0.0734; ...  
       -0.4226     0        0.9063];  
[alpha beta] = dcm2alphabeta(dcm)
```

```
alpha =  
  
    0.4363
```

```
beta =  
  
    0.1745
```

Determine the angle of attack and sideslip angle from multiple direction cosine matrices:

```
dcm = [ 0.8926    0.1736    0.4162; ...  
       -0.1574    0.9848   -0.0734; ...
```

```
    -0.4226      0      0.9063];  
dcm(:, :, 2) = [ 0.9811      0.0872      0.1730; ...  
                -0.0859      0.9962     -0.0151; ...  
                -0.1736      0          0.9848];  
[alpha beta] = dcm2alphabeta(dcm)
```

```
alpha =
```

```
    0.4363  
    0.1745
```

```
beta =
```

```
    0.1745  
    0.0873
```

## See Also

[angle2dcm](#) | [dcm2angle](#) | [dcmbody2wind](#)

**Introduced in R2006b**

## dcm2angle

Create rotation angles from direction cosine matrix

### Syntax

```
[r1 r2 r3] = dcm2angle(n)
[r1 r2 r3] = dcm2angle(n, s)
[r1 r2 r3] = dcm2angle(n, s, lim)
```

### Description

`[r1 r2 r3] = dcm2angle(n)` calculates the set of rotation angles, `r1`, `r2`, `r3`, for a given direction cosine matrix, `n`. `n` is a 3-by-3-by-`m` matrix containing `m` direction cosine matrices. `r1` returns an `m` array of first rotation angles. `r2` returns an `m` array of second rotation angles. `r3` returns an `m` array of third rotation angles. Rotation angles are output in radians. This function applies only to direction cosine matrices that are orthogonal with determinant +1.

`[r1 r2 r3] = dcm2angle(n, s)` calculates the set of rotation angles, `r1`, `r2`, `r3`, for a given direction cosine matrix, `n`, and a specified rotation sequence, `s`.

The default rotation sequence is 'ZYX', where `r1` is z-axis rotation, `r2` is y-axis rotation, and `r3` is x-axis rotation.

Supported rotation sequences are 'ZYX', 'ZYX', 'ZXY', 'ZXZ', 'YXZ', 'YXY', 'YZX', 'YZY', 'XYZ', 'XYX', 'XZY', and 'XZX'.

`[r1 r2 r3] = dcm2angle(n, s, lim)` calculates the set of rotation angles, `r1`, `r2`, `r3`, for a given direction cosine matrix, `n`, a specified rotation sequence, `s`, and a specified angle constraint, `lim`. `lim` specifies either 'Default' or 'ZeroR3'. See “Assumptions and Limitations” on page 4-161 for full definitions of angle constraints.

### Examples

Determine the rotation angles from direction cosine matrix:



```

dcm = [1 0 0; 0 1 0; 0 0 1];
[yaw, pitch, roll] = dcm2angle( dcm )
yaw =

    0

pitch =

    0

roll =

    0

```

Determine the rotation angles from multiple direction cosine matrices:

```

dcm          = [ 1 0 0; 0 1 0; 0 0 1];
dcm(:, :, 2) = [ 0.85253103550038  0.47703040785184 -0.21361840626067; ...
                -0.43212157513194  0.87319830445628  0.22537893734811; ...
                0.29404383655186 -0.09983341664683  0.95056378592206];
[pitch, roll, yaw] = dcm2angle( dcm, 'YXZ' )

pitch =

    0
    0.3000

roll =

    0
    0.1000

yaw =

    0
    0.5000

```

## Assumptions and Limitations

The 'Default' limitations for the 'ZYX', 'ZXY', 'YXZ', 'YZX', 'XYZ', and 'XZY' implementations generate an  $r_2$  angle that lies between  $\pm 90$  degrees, and  $r_1$  and  $r_3$  angles that lie between  $\pm 180$  degrees.

The 'Default' limitations for the 'ZYZ', 'ZXZ', 'YXY', 'YZY', 'YXY', and 'XZX' implementations generate an  $r_2$  angle that lies between 0 and 180 degrees, and  $r_1$  and  $r_3$  angles that lie between  $\pm 180$  degrees.

The 'ZeroR3' limitations for the 'ZYX', 'ZXY', 'YXZ', 'YZX', 'XYZ', and 'XZY' implementations generate an  $r2$  angle that lies between  $\pm 90$  degrees, and  $r1$  and  $r3$  angles that lie between  $\pm 180$  degrees. However, when  $r2$  is  $\pm 90$  degrees,  $r3$  is set to 0 degrees.

The 'ZeroR3' limitations for the 'ZYZ', 'ZXZ', 'YXY', 'YZY', 'XYX', and 'XZX' implementations generate an  $r2$  angle that lies between 0 and 180 degrees, and  $r1$  and  $r3$  angles that lie between  $\pm 180$  degrees. However, when  $r2$  is 0 or  $\pm 180$  degrees,  $r3$  is set to 0 degrees.

### See Also

`angle2dcm` | `dcm2quat` | `quat2dcm` | `quat2angle`

**Introduced in R2006b**

# dcm2latlon

Convert direction cosine matrix to geodetic latitude and longitude

## Syntax

```
[lat lon] = dcm2latlon(n)
```

## Description

`[lat lon] = dcm2latlon(n)` calculates the geodetic latitude and longitude, `lat` and `lon`, for a given direction cosine matrix, `n`. `n` is a 3-by-3-by-`m` matrix containing `m` orthogonal direction cosine matrices. `lat` is an `m` array of geodetic latitudes. `lon` is an `m` array of longitudes. `n` performs the coordinate transformation of a vector in Earth-centered Earth-fixed (ECEF) axes into a vector in north-east-down (NED) axes. Geodetic latitudes and longitudes are output in degrees.

## Examples

Determine the geodetic latitude and longitude from direction cosine matrix:

```
dcm = [ 0.3747    0.5997    0.7071; ...  
        0.8480   -0.5299         0; ...  
        0.3747    0.5997   -0.7071];  
[lat lon] = dcm2latlon(dcm)
```

```
lat =
```

```
    44.9995
```

```
lon =
```

```
   -122.0005
```

Determine the geodetic latitude and longitude from multiple direction cosine matrices:

```
dcm = [ 0.3747    0.5997    0.7071; ...
```

```
    0.8480   -0.5299         0; ...
    0.3747    0.5997   -0.7071];
dcm(:, :, 2) = [-0.0531   0.6064   0.7934; ...
               0.9962   0.0872         0; ...
               -0.0691   0.7903  -0.6088];
[lat lon] = dcm2latlon(dcm)
```

```
lat =
```

```
    44.9995
    37.5028
```

```
lon =
```

```
   -122.0005
    -84.9975
```

### See Also

[angle2dcm](#) | [dcm2angle](#) | [dcmecef2ned](#)

**Introduced in R2006b**

# dcm2quat

Convert direction cosine matrix to quaternion

## Syntax

```
q = dcm2quat(n)
```

## Description

`q = dcm2quat(n)` calculates the quaternion, `q`, for a given direction cosine matrix, `n`. Input `n` is a 3-by-3-by-`m` matrix of orthogonal direction cosine matrices. The direction cosine matrix performs the coordinate transformation of a vector in inertial axes to a vector in body axes. `q` returns an `m`-by-4 matrix containing `m` quaternions. `q` has its scalar number as the first column.

This function applies only to direction cosine matrices that are orthogonal with determinant +1.

## Examples

Determine the quaternion from direction cosine matrix:

```
dcm = [0 1 0; 1 0 0; 0 0 1];
q = dcm2quat(dcm)

q =
```

```
    0.7071         0         0         0
```

Determine the quaternions from multiple direction cosine matrices:

```
dcm          = [ 0 1 0; 1 0 0; 0 0 1];
dcm(:, :, 2) = [ 0.4330    0.2500   -0.8660; ...
                0.1768    0.9186    0.3536; ...
                0.8839   -0.3062    0.3536];
q = dcm2quat(dcm)
```

q =

0.7071	0	0	0
0.8224	0.2006	0.5320	0.0223

### See Also

[angle2dcm](#) | [dcm2angle](#) | [angle2quat](#) | [quat2dcm](#) | [quat2angle](#)

**Introduced in R2006b**

# dcm2rod

Convert direction cosine matrix to Euler-Rodrigues vector

## Syntax

`R=dcm2rod(dcm)`

## Description

`R=dcm2rod(dcm)` function calculates the Euler-Rodrigues vector (**R**) from the direction cosine matrix. This function applies only to direction cosine matrices that are orthogonal with determinant +1.

## Examples

### Determine Rodrigues Vector from Direction Cosine Matrix

Determine the Rodrigues vector from the direction cosine matrix.

```
DCM = [0.433 0.75 0.5; -0.25 -0.433 0.866; 0.866 -0.5 0.0];
r = dcm2rod( DCM )
```

`r =`

```
    1.3660    0.3660    1.0000
```

## Input Arguments

**dcm** — Direction cosine matrix

3-by-3-by-*M* matrix

3-by-3-by-*M* containing *M* direction cosine matrices.

Data Types: double

## Output Arguments

### **R** — Rodrigues vector

*M*-by-3 matrix

*M*-by-3 matrix containing *M* Rodrigues vectors.

Data Types: double

## Algorithms

An Euler-Rodrigues vector  $\vec{b}$  represents a rotation by integrating a direction cosine of a rotation axis with the tangent of half the rotation angle as follows:

$$\vec{b} = [b_x \quad b_y \quad b_z]$$

where:

$$b_x = \tan\left(\frac{1}{2}\theta\right)s_x,$$
$$b_y = \tan\left(\frac{1}{2}\theta\right)s_y,$$
$$b_z = \tan\left(\frac{1}{2}\theta\right)s_z$$

are the Rodrigues parameters. Vector  $\vec{s}$  represents a unit vector around which the rotation is performed. Due to the tangent, the rotation vector is indeterminate when the rotation angle equals  $\pm\pi$  radians or  $\pm 180$  deg. Values can be negative or positive.

## References

- [1] Dai, J.S. "Euler-Rodrigues formula variations, quaternion conjugation and intrinsic connections." *Mechanism and Machine Theory*, 92, 144-152. Elsevier, 2015.



## See Also

### See Also

[angle2rod](#) | [quat2rod](#) | [rod2angle](#) | [rod2dcm](#) | [rod2quat](#)

**Introduced in R2017a**

## dcmbody2wind

Convert angle of attack and sideslip angle to direction cosine matrix

### Syntax

```
n = dcmbody2wind(a, b)
```

### Description

`n = dcmbody2wind(a, b)` calculates the direction cosine matrix, `n`, for given angle of attack and sideslip angle, `a`, `b`. `a` is an `m` array of angles of attack. `b` is an `m` array of sideslip angles. `n` returns a 3-by-3-by-`m` matrix containing `m` direction cosine matrices. `n` performs the coordinate transformation of a vector in body-axes into a vector in wind-axes. Angles of attack and sideslip angles are input in radians.

### Examples

Determine the direction cosine matrix from angle of attack and sideslip angle:

```
alpha = 0.4363;  
beta = 0.1745;  
dcm = dcmbody2wind(alpha, beta)
```

```
dcm =
```

```
    0.8926    0.1736    0.4162  
   -0.1574    0.9848   -0.0734  
   -0.4226         0    0.9063
```

Determine the direction cosine matrix from multiple angles of attack and sideslip angles:

```
alpha = [0.4363 0.1745];  
beta = [0.1745 0.0873];  
dcm = dcmbody2wind(alpha, beta)
```

```
dcm(:, :, 1) =
```

```
  0.8926    0.1736    0.4162
 -0.1574    0.9848   -0.0734
 -0.4226         0    0.9063
```

```
dcm(:, :, 2) =
```

```
  0.9811    0.0872    0.1730
 -0.0859    0.9962   -0.0151
 -0.1736         0    0.9848
```

## See Also

[angle2dcm](#) | [dcm2alphabet](#) | [dcm2angle](#)

**Introduced in R2006b**

## dcmecef2ned

Convert geodetic latitude and longitude to direction cosine matrix

### Syntax

```
n = dcmecef2ned(lat, lon)
```

### Description

`n = dcmecef2ned(lat, lon)` calculates the direction cosine matrix, `n`, for a given set of geodetic latitude and longitude, `lat`, `lon`. `lat` is an `m` array of geodetic latitudes. `lon` is an `m` array of longitudes. Latitude and longitude values can be any value. However, latitude values of +90 and -90 may return unexpected values because of singularity at the poles. `n` returns a 3-by-3-by-`m` matrix containing `m` direction cosine matrices. `n` performs the coordinate transformation of a vector in Earth-centered Earth-fixed (ECEF) axes into a vector in north-east-down (NED) axes. Geodetic latitudes and longitudes are input in degrees.

### Examples

Determine the direction cosine matrix from geodetic latitude and longitude:

```
lat = 45;  
lon = -122;  
dcm = dcmecef2ned(lat, lon)
```

```
dcm =
```

```
    0.3747    0.5997    0.7071  
    0.8480   -0.5299         0  
    0.3747    0.5997   -0.7071
```

Determine the direction cosine matrix from multiple geodetic latitudes and longitudes:

```
lat = [45 37.5];  
lon = [-122 -85];
```

```
dcm = dcmecef2ned(lat, lon)
```

```
dcm(:, :, 1) =
```

```
    0.3747    0.5997    0.7071  
    0.8480   -0.5299         0  
    0.3747    0.5997   -0.7071
```

```
dcm(:, :, 2) =
```

```
   -0.0531    0.6064    0.7934  
    0.9962    0.0872         0  
   -0.0691    0.7903   -0.6088
```

## See Also

[angle2dcm](#) | [dcm2angle](#) | [dcm2latlon](#)

**Introduced in R2006b**

## dcmeci2ecef

Convert Earth-centered inertial (ECI) to Earth-centered Earth-fixed (ECEF) coordinates

### Syntax

```
dcm=dcmeci2ecef(reduction,utc)
```

```
dcm=dcmeci2ecef(reduction,utc,deltaAT)
```

```
dcm=dcmeci2ecef(reduction,utc,deltaAT,deltaUT1)
```

```
dcm=dcmeci2ecef(reduction,utc,deltaAT,deltaUT1,polarmotion)
```

```
dcm=dcmeci2ecef(reduction,utc,deltaAT,deltaUT1,polarmotion,  
Name,Value)
```

### Description

`dcm=dcmeci2ecef(reduction,utc)` calculates the position direction cosine matrix (ECI to ECEF) as a 3-by-3-by-*M* array. The calculation is based on the specified reduction method and Universal Coordinated Time (UTC).

`dcm=dcmeci2ecef(reduction,utc,deltaAT)` uses the difference between International Atomic Time and UTC to calculate the position direction cosine matrix.

`dcm=dcmeci2ecef(reduction,utc,deltaAT,deltaUT1)` uses the difference between UTC and Universal Time (UT1).

`dcm=dcmeci2ecef(reduction,utc,deltaAT,deltaUT1,polarmotion)` uses the polar displacement.

`dcm=dcmeci2ecef(reduction,utc,deltaAT,deltaUT1,polarmotion, Name,Value)` uses additional options specified by one or more Name,Value pair arguments.

## Examples

### Convert using IAU-2000/2006 reduction

Convert Earth-centered inertial (ECI) to Earth-centered Earth-fixed (ECEF) coordinates for January 12, 2000 at 4 hours, 52 minutes, 12.4 seconds and January 12, 2000 at 4 hours, 52 minutes, and 13 seconds. Specify only the reduction method and UTC.

```
dcm = dcmeci2ecef('IAU-2000/2006',[2000 1 12 4 52 12.4;2000 1 12 4 52 13])
```

```
dcm(:, :, 1) =
```

```
-0.9975    -0.0708    0.0000
 0.0708    -0.9975    0.0000
 0.0000     0.0000    1.0000
```

```
dcm(:, :, 2) =
```

```
-0.9975    -0.0709    0.0000
 0.0709    -0.9975    0.0000
 0.0000     0.0000    1.0000
```

### Convert using IAU-76/FK5 reduction

Convert Earth-centered inertial (ECI) to Earth-centered Earth-fixed (ECEF) coordinates for January 12, 2000 at 4 hours, 52 minutes, 12.4 seconds. Specify all arguments, including optional ones such as polar motion.

```
dcm = dcmeci2ecef('IAU-76/FK5',[2000 1 12 4 52 12.4],32,0.234,[0.245 0.3418], 'dNutation', ...
[0.00013 0.00024])
```

```
dcm =
```

```
-0.9975    -0.0707    0.2450
 0.0707    -0.9976   -0.3416
 0.2686    -0.3234    1.0001
```

## Input Arguments

### reduction — Reduction method

```
'IAU-76/FK5' | 'IAU-2000/2006'
```

Reduction method to calculate the direction cosine matrix, specified as one of the following:

- IAU-76/FK5

Reduce the calculation using the International Astronomical Union (IAU)-76/Fifth Fundamental Catalogue (FK5) (IAU-76/FK5) reference system. Choose this reduction method if the reference coordinate system for the conversion is FK5. You can use the 'dNutation' Name,Value pair with this reduction.

---

**Note:** This method uses the IAU 1976 precession model and the IAU 1980 theory of nutation to reduce the calculation. This model and theory are no longer current, but the software provides this reduction method for existing implementations. Because of the polar motion approximation that this reduction method uses, `dcmeci2ecf` calculates the transformation matrix rather than the direction cosine matrix.

---

- IAU-2000/2006

Reduce the calculation using the International Astronomical Union (IAU)-2000/2005 reference system. Choose this reduction method if the reference coordinate system for the conversion is IAU-2000. This reduction method uses the P03 precession model to reduce the calculation. You can use the 'dCIP' Name,Value pair with this reduction.

### **utc – Universal Coordinated Time**

1-by-6 array | *M*-by-6 matrix

Universal Coordinated Time (UTC) in the order year, month, day, hour, minutes, and seconds, for which the function calculates the direction cosine matrix, specified as one of the following.

- For the year value, enter a double value that is a whole number greater than 1, such as 2013.
- For the month value, enter a double value that is a whole number greater than 0, within the range 1 to 12.
- For the hour value, enter a double value that is a whole number greater than 0, within the range 1 to 24.
- For the minute value, enter a double value that is a whole number greater than 0, within the range 1 to 60.
- For the minute and second values, enter a double value that is a whole number greater than 0, within the range 1 to 60.



Specify these values in one of the following formats:

- 1-by-6 array

Specify a 1-row-by-6-column array of UTC values to calculate one direction cosine or transformation matrix.

- $M$ -by-6 matrix

Specify an  $M$ -by-6 array of UTC values, where  $M$  is the number of direction cosine or transformation matrices to calculate. Each row corresponds to one set of UTC values.

Example: [2000 1 12 4 52 12.4]

This is a one row-by-6 column array of UTC values.

Example: [2000 1 12 4 52 12.4;2010 6 5 7 22 0]

This is an  $M$ -by-6 array of UTC values, where  $M$  is 2.

Data Types: double

### **deltaAT — Difference between International Atomic Time and UTC**

scalar | one-dimensional array

Difference between International Atomic Time (IAT) and UTC, in seconds, for which the function calculates the direction cosine or transformation matrix. By default, the function assumes an  $M$ -by-1 array of zeroes.

- scalar

Specify one difference-time value to calculate one direction cosine or transformation matrix.

- one-dimensional array

Specify a one-dimensional array with  $M$  elements, where  $M$  is the number of direction cosine or transformation matrices to calculate. Each row corresponds to one set of UTC values.

Example: 32

Specify 32 seconds as the difference between IAT and UTC.

Data Types: double

### **deltaUT1 — Difference between UTC and Universal Time (UT1)**

scalar | one-dimensional array

Difference between UTC and Universal Time (UT1) in seconds, for which the function calculates the direction cosine or transformation matrix. By default, the function assumes an  $M$ -by-1 array of zeroes.

- scalar

Specify one difference-time value to calculate one direction cosine or transformation matrix.

- one-dimensional array

Specify a one-dimensional array with  $M$  elements of difference time values, where  $M$  is the number of direction cosine or transformation matrices to be calculated. Each row corresponds to one set of UTC values.

Example: 0.234

Specify 0.234 seconds as the difference between UTC and UT1.

Data Types: double

### **polarmotion — Polar displacement**

1-by-2 array |  $M$ -by-2 array

Polar displacement of the Earth, in radians, from the motion of the Earth crust, along the  $x$ - and  $y$ -axes. By default, the function assumes an  $M$ -by-2 array of zeroes.

- 1-by-2 array

Specify a 1-by-2 array of the polar displacement values to convert one direction cosine or transformation matrix.

- $M$ -by-2 array

Specify an  $M$ -by-2 array of polar displacement values, where  $M$  is the number of direction cosine or transformation matrices to convert. Each row corresponds to one set of UTC values.

Example: [-0.0682e-5 0.1616e-5]

Data Types: double

## Name-Value Pair Arguments

Specify optional comma-separated pairs of `Name`, `Value` arguments. `Name` is the argument name and `Value` is the corresponding value. `Name` must appear inside single quotes (' '). You can specify several name and value pair arguments in any order as `Name1, Value1, ..., NameN, ValueN`.

Example: [-0.2530e-6 -0.0188e-6]

### '`dNutation`' — Adjustment to longitude (`dDeltaPsi`) and obliquity (`dDeltaEpsilon`)

*M*-by-2 array

Adjustment to the longitude (`dDeltaPsi`) and obliquity (`dDeltaEpsilon`), in radians, as the comma-separated pair consisting of `dNutation` and an *M*-by-2 array. Use this `Name, Value` pair with the IAU-76/FK5 reduction. By default, the function assumes an *M*-by-2 array of zeroes.

For historical values, see the International Earth Rotation and Reference Systems Service Web site (<http://www.iers.org>) and navigate to the Earth Orientation Data Data/Products page.

- *M*-by-2 array

Specify *M*-by-2 array of adjustment values, where *M* is the number of direction cosine or transformation matrices to be converted. Each row corresponds to one set of longitude and obliquity values.

Data Types: double

### '`dCIP`' — Adjustment to the location of the Celestial Intermediate Pole (CIP)

*M*-by-2 array

Adjustment to the location of the Celestial Intermediate Pole (CIP), in radians, specified as the comma-separated pair consisting of `dCIP` and an *M*-by-2 array. This location (`dDeltaX`, `dDeltaY`) is along the *x*- and *y*- axes. Use this argument with the IAU-200/2006 reduction. By default, this function assumes an *M*-by-2 array of zeroes.

For historical values, see the International Earth Rotation and Reference Systems Service Web site (<http://www.iers.org>) and navigate to the Earth Orientation Data Data/Products page.

- *M*-by-2 array

Specify  $M$ -by-2 array of location adjustment values, where  $M$  is the number of direction cosine or transformation matrices to be converted. Each row corresponds to one set of  $dDeltaX$  and  $dDeltaY$  values.

Example: [ -0.2530e-6 -0.0188e-6 ]

Data Types: double

## Output Arguments

**dcm** — Direction cosine or transformation matrix  
3-by-3- $M$  array

Direction cosine or transformation matrix, returned as a 3-by-3- $M$  array.

## See Also

### See Also

[ecef2lla](#) | [geoc2geod](#) | [geod2geoc](#) | [lla2ecef](#)

### Topics

<http://www.iers.org>

Introduced in R2013b

# decyear

Decimal year calculator

## Syntax

```
dy = decyear(v)
dy = decyear(s,f)
dy = decyear(y,mo,d)
dy = decyear([y,mo,d])
dy = decyear(y,mo,d,h,mi,s)
dy = decyear([y,mo,d,h,mi,s])
```

## Description

`dy = decyear(v)` converts one or more date vectors, `v`, into decimal year, `dy`. Input `v` can be an `m`-by-6 or `m`-by-3 matrix containing `m` full or partial date vectors, respectively. `decyear` returns a column vector of `m` decimal years.

A date vector contains six elements, specifying year, month, day, hour, minute, and second. A partial date vector has three elements, specifying year, month, and day. Each element of `v` must be a positive double-precision number.

`dy = decyear(s,f)` converts one or more date character vectors, `s`, to decimal year, `dy`, using format `f`. `s` can be a character array, where each row corresponds to one date, or a one-dimensional cell array of character vectors. `decyear` returns a column vector of `m` decimal years, where `m` is the number of character vectors in `s`.

All of the dates in `s` must have the same format `f`, composed of the same date format symbols as the `datestr` function. `decyear` does not accept formats containing the letter `Q`.

If a format does not contain enough information to compute a date number, then:

- Hours, minutes, and seconds default to 0.
- Days default to 1.
- Months default to January.
- Years default to the current year.

Dates with two-character years are interpreted to be within 100 years of the current year.

`dy = decyear(y,mo,d)` and `dy = decyear([y,mo,d])` return the decimal year for corresponding elements of the `y,mo,d` (year,month,day) arrays. Specify `y, mo,` and `d` as one-dimensional arrays of the same length or scalar values.

`dy = decyear(y,mo,d,h,mi,s)` and `dy = decyear([y,mo,d,h,mi,s])` return the decimal year for corresponding elements of the `y,mo,d,h,mi,s` (year,month,day,hour,minute,second) arrays. Specify the six arguments as one-dimensional arrays of the same length or scalar values.

### Examples

Calculate decimal year for May 24, 2005:

```
dy = decyear('24-May-2005','dd-mmm-yyyy')
```

```
dy =
```

```
2.0054e+003
```

Calculate decimal year for December 19, 2006:

```
dy = decyear(2006,12,19)
```

```
dy =
```

```
2.0070e+003
```

Calculate decimal year for October 10, 2004, at 12:21:00 p.m.:

```
dy = decyear(2004,10,10,12,21,0)
```

```
dy =
```

```
2.0048e+003
```

### Assumptions and Limitations

The calculation of decimal year does not take into account leap seconds.

## See Also

juliandate | leapyear | mjuliandate

**Introduced in R2006b**

# delete

**Class:** Aero.Animation

**Package:** Aero

Destroy animation object

## Syntax

```
delete(h)  
h.delete
```

## Description

`delete(h)` and `h.delete` destroy the animation object `h`. This function also destroys the animation object figure, and any objects that the animation object contained (for example, bodies, camera, and geometry).

## Input Arguments

`h`                      Animation object.

## Examples

Delete the animation object, `h`.

```
h=Aero.Animation;  
h.delete;
```



## delete (Aero.FlightGearAnimation)

Destroy FlightGear animation object

### Syntax

```
delete(h)  
h.delete
```

### Description

`delete(h)` and `h.delete` destroy the FlightGear animation object `h`. This function also destroys the animation object timer, and closes the socket that the FlightGear animation object contains.

### Examples

Delete the FlightGear animation object, `h`.

```
h=Aero.FlightGearAnimation;  
h.delete;
```

### See Also

`initialize`

**Introduced in R2007a**

## delete (Aero.VirtualRealityAnimation)

Destroy virtual reality animation object

### Syntax

```
delete(h)  
h.delete
```

### Description

`delete(h)` and `h.delete` destroy the virtual reality animation object `h`. This function also destroys the temporary file, if it exists, cleans up the `vrfigure` object, the animation object timer, and closes the `vrworld` object.

### Examples

Delete the virtual reality animation object, `h`.

```
h=Aero.VirtualRealityAnimation;  
h.delete;
```

### See Also

`initialize`

**Introduced in R2007b**

## dpressure

Compute dynamic pressure using velocity and density

### Syntax

```
q = dpressure(v, r)
```

### Description

`q = dpressure(v, r)` computes  $m$  dynamic pressures,  $q$ , from an  $m$ -by-3 array of velocities,  $v$ , and an array of  $m$  densities,  $r$ .  $v$  and  $r$  must have the same length units.

### Examples

Determine dynamic pressure for velocity in feet per second and density in slugs per feet cubed:

```
q = dpressure([84.3905 33.7562 10.1269], 0.0024)
```

```
q =
```

```
10.0365
```

Determine dynamic pressure for velocity in meters per second and density in kilograms per meters cubed:

```
q = dpressure([25.7222 10.2889 3.0867], [1.225 0.3639])
```

```
q =
```

```
475.9252  
141.3789
```

Determine dynamic pressure for velocity in meters per second and density in kilograms per meters cubed:

```
q = dpressure([50 20 6; 5 0.5 2], [1.225 0.3639])
```

```
q =
```

```
1.0e+003 *
```

```
1.7983
```

```
0.0053
```

### See Also

[airspeed](#) | [machnumber](#)

**Introduced in R2006b**

# earthNutation

Implement Earth nutation

## Syntax

```
angles= earthNutation(ephemerisTime)  
angles= earthNutation(ephemerisTime,ephemerisModel)  
angles= earthNutation(ephemerisTime,ephemerisModel,action)
```

```
[angles,rates] = earthNutation( ___ )
```

## Description

`angles= earthNutation(ephemerisTime)` implements the International Astronomical Union (IAU) 1980 nutation series for `ephemerisTime`, expressed in Julian days. It returns `angles`.

The function uses the Chebyshev coefficients that the NASA Jet Propulsion Laboratory provides.

This function requires that you download ephemeris data with the Add-On Explorer. For more information, see `aeroDataPackage`.

`angles= earthNutation(ephemerisTime,ephemerisModel)` uses the `ephemerisModel` coefficients to implement these values.

`angles= earthNutation(ephemerisTime,ephemerisModel,action)` uses `action` to determine error reporting.

`[angles,rates] = earthNutation( ___ )` implements the International Astronomical Union (IAU) 1980 nutation series using any combination of the input arguments in the previous syntaxes. It returns `angles` and angular rates.

# Examples

## Implement Earth Nutation Angles

Implement Earth nutation angles for December 1, 1990. Because no ephemerides model is specified, the default, DE405, is used. Use the `juliandate` function to specify the Julian date.

```
angles = earthNutation(juliandate(1990,12,1))
```

```
angles =  
  1.0e-04 *  
  0.6448    0.2083
```

## Implement Earth Nutation Angles and Angular Rates

Implement Earth nutation angles and angular rates for noon on January 1, 2000 using DE421:

```
[angles,rates] = earthNutation([2451544.5 0.5], '421')
```

```
angles =  
  1.0e-04 *  
 -0.6750   -0.2799
```

```
rates =  
  1.0e-07 *  
  0.3687   -0.9937
```

# Input Arguments

## **ephemerisTime** — Julian date

scalar | 2-element vector | column vector |  $M$ -by-2 matrix

Julian dates for which the positions are calculated, specified as one of the following:

- Scalar  
Specify one fixed Julian date.
- 2-element vector

Specify the Julian date in multiple parts. The first element is the Julian date for a specific epoch that is the most recent midnight at or before the interpolation epoch. The second element is the fractional part of a day elapsed between the first element and epoch. The second element must be positive. The value of the first element plus the second element cannot exceed the maximum Julian date.

- Column vector

Specify a column vector with  $M$  elements, where  $M$  is the number of fixed Julian dates.

- $M$ -by-2 matrix

Specify a matrix, where  $M$  is the number of Julian dates and the second column contains the elapsed days (Julian epoch date/elapsed day pairs).

Data Types: double

### **ephemerisModel** — Ephemerides coefficients

'405' (default) | '421' | '423' | '430'

Ephemerides coefficients, specified as one of these ephemerides defined by the Jet Propulsion Laboratory:

- '405'

Released in 1998. This ephemerides takes into account the Julian date range 2305424.50 (December 9, 1599) to 2525008.50 (February 20, 2201).

This function calculates these ephemerides with respect to the International Celestial Reference Frame version 1.0, adopted in 1998.

- '421'

Released in 2008. This ephemerides takes into account the Julian date range 2414992.5 (December 4, 1899) to 2469808.5 (January 2, 2050).

This function calculates these ephemerides with respect to the International Celestial Reference Frame version 1.0, adopted in 1998.

- '423'

Released in 2010. This ephemerides takes into account the Julian date range 2378480.5 (December 16, 1799) to 2524624.5 (February 1, 2200).

This function calculates these ephemerides with respect to the International Celestial Reference Frame version 2.0, adopted in 2010.

- '430'

Released in 2013. This ephemerides takes into account the Julian date range 2287184.5 (December 21, 1549) to 2688976.5 (January 25, 2650).

This block implements these ephemerides with respect to the International Celestial Reference Frame version 2.0, adopted in 2010.

Data Types: char

**action — Function behavior**

'Error' (default) | 'None' | 'Warning'

Function behavior when inputs are out of range, specified as one of these values:

Value	Description
'None'	No action.
'Warning'	Warning in the MATLAB Command Window, model simulation continues.
'Error'	MATLAB returns an exception, model simulation stops.

Data Types: char

## Output Arguments

**angles — Earth nutation angles**

*M*-by-2 vector

Earth nutation angles, returned as an *M*-by-2 vector, where *M* is the number of Julian dates. The 2 vector contains the *d(psi)* and *d(epsilon)* angles, in radians. The input arguments include multiple Julian dates or epochs. The vector has the same number of rows as the `ephemerisTime` input.

**rates — Earth nutation angular rates**

*M*-by-2 vector



Earth nutation angular rates, returned as an  $M$ -by-2 vector, where  $M$  is the number of Julian dates. The 2 vector contains the  $d(\psi)$  and  $d(\epsilon)$  angular rate, in radians/day. The input arguments include multiple Julian dates or epochs. The vector has the same number of rows as the `ephemerisTime` input.

## References

- [1] Folkner, W. M., J. G. Williams, D. H. Boggs, “The Planetary and Lunar Ephemeris DE 421,” *JPL Interplanetary Network Progress Report 24-178*, 2009.
- [2] Vallado, D. A., *Fundamentals of Astrodynamics and Applications*, McGraw-Hill, New York, 1997.

## See Also

### See Also

`juliandate` | `moonLibration` | `planetEphemeris`

### External Websites

[http://ssd.jpl.nasa.gov/?planet\\_eph\\_export](http://ssd.jpl.nasa.gov/?planet_eph_export)

Introduced in R2013a

# ecef2lla

Convert Earth-centered Earth-fixed (ECEF) coordinates to geodetic coordinates

## Syntax

```
lla = ecef2lla(p)
lla = ecef2lla(p, model)
lla = ecef2lla(p, f, Re)
```

## Description

`lla = ecef2lla(p)` converts the  $m$ -by-3 array of ECEF coordinates,  $p$ , to an  $m$ -by-3 array of geodetic coordinates (latitude, longitude and altitude),  $lla$ .  $lla$  is in [degrees meters].  $p$  is in meters. The default ellipsoid planet is WGS84.

`lla = ecef2lla(p, model)` is an alternate method for converting the coordinates for a specific ellipsoid planet. Currently only 'WGS84' is supported for `model`.

`lla = ecef2lla(p, f, Re)` is another alternate method for converting the coordinates for a custom ellipsoid planet defined by flattening,  $f$ , and the equatorial radius,  $Re$ , in meters.

## Examples

Determine latitude, longitude, and altitude at a coordinate:

```
lla = ecef2lla([4510731 4510731 0])
```

```
lla =
```

```
0 45.0000 999.9564
```

Determine latitude, longitude, and altitude at multiple coordinates, specifying WGS84 ellipsoid model:

```
lla = ecef2lla([4510731 4510731 0; 0 4507609 4498719], 'WGS84')
```

```
lla =
```

```
      0  45.0000  999.9564
45.1358  90.0000  999.8659
```

Determine latitude, longitude, and altitude at multiple coordinates, specifying custom ellipsoid model:

```
f = 1/196.877360;
Re = 3397000;
lla = ecef2lla([4510731 4510731 0; 0 4507609 4498719], f, Re)
```

```
lla =
```

```
1.0e+006 *
      0  0.0000  2.9821
0.0000  0.0001  2.9801
```

## See Also

[geoc2geod](#) | [geod2geoc](#) | [lla2ecef](#)

**Introduced in R2006b**

## eci2aer

Convert Earth-centered inertial (ECI) coordinates to azimuth, elevation, slant range (AER) coordinates

### Syntax

```
aer = eci2aer(position,utc,lla0)

aer = eci2aer(position,utc,lla0,reduction)
aer = eci2aer(position,utc,lla0,reduction,deltaAT)
aer = eci2aer(position,utc,lla0,reduction,deltaAT,deltaUT1)
aer = eci2aer(position,utc,lla0,reduction,deltaAT,deltaUT1,
polarmotion)
aer = eci2aer(position,utc,lla0,reduction,deltaAT,deltaUT1,
polarmotion,Name,Value)
```

### Description

`aer = eci2aer(position,utc,lla0)` converts Earth-centered inertial coordinates, specified by `position`, to azimuth, elevation, and slant range (AER) coordinates, based on the geodetic position (latitude, longitude, and altitude). The conversion is based on the Universal Coordinated Time (UTC) you specify.

- Azimuth (A) — Angle measured clockwise from true north. It ranges from 0 to 360 degrees.
- Elevation (E) — Angle between a plane perpendicular to the ellipsoid and the line that goes from the local reference to the object position. It ranges from -90 to 90 degrees.
- Slant range (R) — Straight line distance between the local reference and the object, meters.

`aer = eci2aer(position,utc,lla0,reduction)` converts Earth-centered inertial coordinates, specified by `position`, to azimuth, elevation, and slant range coordinates. The conversion is based on the specified reduction method and the Universal Coordinated Time you specify.

`aer = eci2aer(position,utc,lla0,reduction,deltaAT)` uses the difference between International Atomic Time and UTC that you specify as `deltaAT` to calculate the AER coordinates.

`aer = eci2aer(position,utc,lla0,reduction,deltaAT,deltaUT1)` uses the difference between UTC and Universal Time (UT1), which you specify as `deltaUT1`, in the calculation.

`aer = eci2aer(position,utc,lla0,reduction,deltaAT,deltaUT1,polarmotion)` uses the polar displacement, `polarmotion`, in the calculation.

`aer = eci2aer(position,utc,lla0,reduction,deltaAT,deltaUT1,polarmotion,Name,Value)` uses additional options specified by one or more `Name,Value` pair arguments.

## Examples

### Convert Position to AER Coordinates Using UTC

Convert the position to AER coordinates from ECI coordinates  $1e08*[-3.8454 -0.5099 -0.3255]$  meters for the date 1969/7/20 21:17:40 UTC at 28.4 degrees north, 80.5 degrees west and 2.7 meters altitude.

```
aer = eci2aer(1e08*[-3.8454, -0.5099, -0.3255], ...
[1969,7,20,21,17,40], [28.4, -80.5,2.7])
```

```
aer =
```

```
1.0e+08 *
0.0000    0.0000    3.8401
```

### Convert Position to AER Coordinates Using UTC and Reduction Method IAU-76/FK5

Convert the position to AER coordinates from ECI coordinates  $1e08*[-3.8454 -0.5099 -0.3255]$  meters for the date 1969/7/20 21:17:40 UTC at 28.4 degrees north, 80.5 degrees west and 2.7 meters altitude. For an ellipsoid with a flattening of 1/290 and an equatorial radius of 60000 meters, use the IAU-76/FK5 reduction, polar motion  $[-0.0682e-5 0.1616e-5]$  radians, and nutation angles  $[-0.2530e-6 -0.0188e-6]$ .

```
aer = eci2aer(1e08*[-3.8454, -0.5099, -0.3255], ...
```

```
[1969,7,20,21,17,40],[28.4,-80.5,2.7],...  
'IAU-76/FK5',32,0.234,[-0.0682e-5 0.1616e-5],...  
'dNutation',[-0.2530e-6 -0.0188e-6],...  
'flattening',1/290,'RE',60000)
```

aer =

```
1.0e+08 *  
  
0.0000    0.0000    3.8922
```

## Input Arguments

### **position** — ECI coordinates

*M*-by-3 array

ECI coordinates in meters, specified as an *M*-by-3 array.

### **utc** — Universal Coordinated Time

1-by-6 array of whole numbers | *M*-by-6 matrix of whole numbers

Universal Coordinated Time (UTC), in the order year, month, day, hour, minutes, and seconds, for which the function calculates the conversion, specified as one of the following:

- For the year value, enter a double value that is a whole number greater than 1, such as 2013.
- For the month value, enter a double value that is a whole number greater than 0, within the range 1 to 12.
- For the hour value, enter a double value that is a whole number greater than 0, within the range 1 to 24.
- For the hour value, enter a double value that is a whole number greater than 0, within the range 1 to 60.
- For the minute and second values, enter a double value that is a whole number greater than 0, within the range 1 to 60.

Specify these values in one of the following formats:

- 1-by-6 array

Specify a 1-row-by-6-column array of UTC values.

- *M*-by-6 matrix

Specify an *M*-by-6 array of UTC values, where *M* is the number of transformation matrices to calculate. Each row corresponds to one set of UTC values.

This example is a one-row-by-6-column array of UTC values.

Example: [2000 1 12 4 52 12.4]

This example is an *M*-by-6 array of UTC values, where *M* is 2.

Example: [2000 1 12 4 52 12.4;2010 6 5 7 22 0]

Data Types: double

### 11a0 — Geodetic coordinates

*M*-by-3 array

Geodetic coordinates of the local reference (latitude, longitude, and ellipsoidal altitude), in degrees, degrees, and meters. Latitude and longitude values can be any value. However, latitude values of +90 and -90 can return unexpected values because of singularity at the poles.

#### reduction — Reduction method

'IAU-2000/2006' (default) | 'IAU-76/FK5'

Reduction method to calculate the coordinate conversion, specified as one of the following:

- 'IAU-76/FK5'

Reduce the calculation using the International Astronomical Union (IAU)-76/Fifth Fundamental Catalogue (FK5) (IAU-76/FK5) reference system. Choose this reduction method if the reference coordinate system for the conversion is FK5. You can use the 'dNutation' Name,Value pair with this reduction.

---

**Note:** This method uses the IAU 1976 precession model and the IAU 1980 theory of nutation to reduce the calculation. This model and theory are no longer current, but the software provides this reduction method for existing implementations. Because of the polar motion approximation that this reduction method uses, **eci2aer** performs a coordinate conversion that is not orthogonal due to the polar motion approximation.

---

- 'IAU-2000/2006'

Reduce the calculation using the International Astronomical Union (IAU)-2000/2005 reference system. Choose this reduction method if the reference coordinate system for the conversion is IAU-2000. This reduction method uses the P03 precession model to reduce the calculation. You can use the 'dCIP' Name,Value pair with this reduction.

### **deltaAT — Difference between International Atomic Time and UTC**

scalar | one-dimensional array

Difference between International Atomic Time (IAT) and UTC, in seconds, for which the function calculates the direction cosine or transformation matrix. By default, the function assumes an  $M$ -by-1 array of zeroes.

- scalar

Specify one difference-time value to calculate one direction cosine or transformation matrix.

- one-dimensional array

Specify a one-dimensional array with  $M$  elements, where  $M$  is the number of direction cosine or transformation matrices to calculate. Each row corresponds to one set of UTC values.

Example: 32

Specify 32 seconds as the difference between IAT and UTC.

Data Types: double

### **deltaUT1 — Difference between UTC and Universal Time (UT1)**

scalar | one-dimensional array

Difference between UTC and Universal Time (UT1) in seconds, for which the function calculates the direction cosine or transformation matrix. By default, the function assumes an  $M$ -by-1 array of zeroes.

- scalar

Specify one difference-time value to calculate one direction cosine or transformation matrix.

- one-dimensional array



Specify a one-dimensional array with  $M$  elements of difference time values, where  $M$  is the number of direction cosine or transformation matrices to be calculated. Each row corresponds to one set of UTC values.

Example: 0.234

Specify 0.234 seconds as the difference between UTC and UT1.

Data Types: double

### **polarmotion — Polar displacement**

1-by-2 array |  $M$ -by-2 array

Polar displacement of the Earth, in radians, from the motion of the Earth crust, along the  $x$ - and  $y$ -axes. By default, the function assumes an  $M$ -by-2 array of zeroes.

- 1-by-2 array

Specify a 1-by-2 array of the polar displacement values to convert one direction cosine or transformation matrix.

- $M$ -by-2 array

Specify an  $M$ -by-2 array of polar displacement values, where  $M$  is the number of direction cosine or transformation matrices to convert. Each row corresponds to one set of UTC values.

Example: [-0.0682e-5 0.1616e-5]

Data Types: double

## **Name-Value Pair Arguments**

Specify optional comma-separated pairs of **Name**, **Value** arguments. **Name** is the argument name and **Value** is the corresponding value. **Name** must appear inside single quotes (' '). You can specify several name and value pair arguments in any order as **Name1**, **Value1**, ..., **NameN**, **ValueN**.

Example: 'dNutation', [-0.2530e-6 -0.0188e-6]

### **'dNutation' — Adjustment to longitude ( $d\Delta\psi$ ) and obliquity ( $d\Delta\epsilon$ )**

$M$ -by-2 array of zeroes (default) |  $M$ -by-2 array

Adjustment to the longitude (*dDeltaPsi*) and obliquity (*dDeltaEpsilon*), in radians, specified as the comma-separated pair consisting of 'dNutation' and an *M*-by-2 array. You can use this Name,Value pair with the IAU-76/FK5 reduction.

For historical values, see the International Earth Rotation and Reference Systems Service website (<http://www.iers.org>) and navigate to the Earth Orientation Data Data/Products page.

- *M*-by-2 array

Specify *M*-by-2 array of adjustment values, where *M* is the number of LLA coordinates to be converted. Each row corresponds to one set of longitude and obliquity values.

Data Types: double

### 'dCIP' — Adjustment to the location of the celestial intermediate pole (CIP)

*M*-by-2 array of zeroes (default)

Adjustment to the location of the celestial intermediate pole (CIP), in radians, specified as the comma-separated pair consisting of 'dCIP' and an *M*-by-2 array. This location (*dDeltaX*, *dDeltaY*) is along the *x*- and *y*- axes. You can use this argument with the IAU-200/2006 reduction.

For historical values, see the International Earth Rotation and Reference Systems Service website (<http://www.iers.org>) and navigate to the Earth Orientation Data Data/Products page.

- *M*-by-2 array

Specify *M*-by-2 array of location adjustment values, where *M* is the number of LLA coordinates to convert. Each row corresponds to one set of *dDeltaX* and *dDeltaY* values.

Example: 'dCIP', [-0.2530e-6 -0.0188e-6]

Data Types: double

### 'flattening' — Custom ellipsoid planet

1-by-1 array

Custom ellipsoid planet defined by flattening, specified as the comma-separated pair consisting of 'flattening' and a 1-by-1 array.

Example: 1/290

Data Types: double

### 're' — Custom planet ellipsoid radius

1-by-1 array

Custom planet ellipsoid radius, in meters, specified as the comma-separated pair consisting of 're' and a 1-by-1 array.

Example: 60000

Data Types: double

## See Also

### See Also

[dcmeci2ecef](#) | [ecef2lla](#) | [geoc2geod](#) | [geod2geoc](#) | [lla2ecef](#) | [lla2eci](#)

**Introduced in R2015a**

## eci2lla

Convert Earth-centered inertial (ECI) coordinates to latitude, longitude, altitude (LLA) geodetic coordinates

### Syntax

```
lla = eci2lla(position,utc)
```

```
lla = eci2lla(position,utc,reduction)
```

```
lla = eci2lla(position,utc,reduction,deltaAT)
```

```
lla = eci2lla(position,utc,reduction,deltaAT,deltaUT1)
```

```
lla = eci2lla(position,utc,reduction,deltaAT,deltaUT1,polarmotion)
```

```
lla = eci2lla(position,utc,reduction,deltaAT,deltaUT1,polarmotion,  
Name,Value)
```

### Description

`lla = eci2lla(position,utc)` converts Earth-centered inertial (ECI) coordinates, specified by `position`, to latitude, longitude, altitude (LLA) geodetic coordinates. The conversion is based on the Universal Coordinated Time (UTC) you specify.

`lla = eci2lla(position,utc,reduction)` converts Earth-centered inertial (ECI) coordinates, specified by `position`, to latitude, longitude, altitude (LLA) geodetic coordinates. The conversion is based on the specified reduction method and the Universal Coordinated Time (UTC) you specify.

`lla = eci2lla(position,utc,reduction,deltaAT)` uses the difference between International Atomic Time and UTC that you specify as `deltaAT` to calculate the ECI coordinates.

`lla = eci2lla(position,utc,reduction,deltaAT,deltaUT1)` uses the difference between UTC and Universal Time (UT1), which you specify as `deltaUT1`, in the calculation.

`lla = eci2lla(position,utc,reduction,deltaAT,deltaUT1,polarmotion)` uses the polar displacement, `polarmotion`, in the calculation.

`lla = eci2lla(position, utc, reduction, deltaAT, deltaUT1, polarmotion, Name, Value)` uses additional options specified by one or more Name, Value pair arguments.

## Examples

### Convert Position to LLA Coordinates Using UTC

Convert the position to LLA coordinates from ECI coordinates  $[-6.07 \ -1.28 \ 0.66] \times 10^6$  at 01/17/2010 10:20:36 UTC.

```
lla = eci2lla([-6.07 -1.28 0.66]*1e6,[2010 1 17 10 20 36])
lla =
    1.0e+05 *
    0.0001    -0.0008    -1.3940
```

### Convert Position to LLA Coordinates Using UTC and Reduction Method IAU-76/FK5

Convert the position to LLA coordinates from ECI coordinates  $[-1.1 \ 3.2 \ -4.9] \times 10^4$  at 01/12/2000 4:52:12.4 UTC, with a difference of 32 seconds between TAI and UTC, and 0.234 seconds between UTC and UT1. For an ellipsoid with a flattening of 1/290 and an equatorial radius of 60000 meters, use the IAU-76/FK5 reduction, polar motion  $[-0.0682 \times 10^{-5} \ 0.1616 \times 10^{-5}]$  radians, and nutation angles  $[-0.2530 \times 10^{-6} \ -0.0188 \times 10^{-6}]$ .

```
lla = eci2lla([-1.1 3.2 -4.9]*1e4,[2000 1 12 4 52 12.4],...
'IAU-76/FK5',32,0.234,[-0.0682e-5 0.1616e-5],'dNutation'...
,[-0.2530e-6 -0.0188e-6],...
'flattening',1/290,'RE',60000)
lla =
    -55.5592    -75.0892   -311.3709
```

## Input Arguments

**position** — ECI coordinates

*M*-by-3 array

ECI coordinates in meters, specified as an  $M$ -by-3 array.

### **utc** — Universal Coordinated Time

1-by-6 array |  $M$ -by-6 matrix

Universal Coordinated Time (UTC), in the order year, month, day, hour, minutes, and seconds, for which the function calculates the conversion, specified as one of the following:

- For the year value, enter a double value that is a whole number greater than 1, such as 2013.
- For the month value, enter a double value that is a whole number greater than 0, within the range 1 to 12.
- For the hour value, enter a double value that is a whole number greater than 0, within the range 1 to 24.
- For the hour value, enter a double value that is a whole number greater than 0, within the range 1 to 60.
- For the minute and second values, enter a double value that is a whole number greater than 0, within the range 1 to 60.

Specify these values in one of the following formats:

- 1-by-6 array

Specify a 1-row-by-6-column array of UTC values.

- $M$ -by-6 matrix

Specify an  $M$ -by-6 array of UTC values, where  $M$  is the number of transformation matrices to calculate. Each row corresponds to one set of UTC values.

This is a one row-by-6 column array of UTC values.

Example: [2000 1 12 4 52 12.4]

This is an  $M$ -by-6 array of UTC values, where  $M$  is 2.

Example: [2000 1 12 4 52 12.4;2010 6 5 7 22 0]

Data Types: double

### **reduction** — Reduction method

'IAU-2000/2006' (default) | 'IAU-76/FK5'

Reduction method to calculate the coordinate conversion, specified as one of the following:

- 'IAU-76/FK5'

Reduce the calculation using the International Astronomical Union (IAU)-76/Fifth Fundamental Catalogue (FK5) (IAU-76/FK5) reference system. Choose this reduction method if the reference coordinate system for the conversion is FK5. You can use the 'dNutation' Name,Value pair with this reduction.

---

**Note:** This method uses the IAU 1976 precession model and the IAU 1980 theory of nutation to reduce the calculation. This model and theory are no longer current, but the software provides this reduction method for existing implementations. Because of the polar motion approximation that this reduction method uses, `eci2lla` performs a coordinate conversion that is not orthogonal because of the polar motion approximation.

---

- 'IAU-2000/2006'

Reduce the calculation using the International Astronomical Union (IAU)-2000/2005 reference system. Choose this reduction method if the reference coordinate system for the conversion is IAU-2000. This reduction method uses the P03 precession model to reduce the calculation. You can use the 'dCIP' Name,Value pair with this reduction.

### **deltaAT — Difference between International Atomic Time and UTC**

*M*-by-1 array of zeroes (default) | scalar | one-dimensional array

Difference between International Atomic Time (IAT) and UTC, in seconds, for which the function calculates the coordinate conversion.

- scalar

Specify difference-time value to calculate one direction cosine or transformation matrix.

- one-dimensional array

Specify a one-dimensional array with *M* elements, where *M* is the number of ECI coordinates. Each row corresponds to one set of ECI coordinates.

Specify 32 seconds as the difference between IAT and UTC.

Example: 32

Data Types: double

### **deltaUT1 — Difference between UTC and Universal Time (UT1)**

*M*-by-1 array of zeroes (default) | scalar | one-dimensional array

Difference between UTC and Universal Time (UT1), in seconds, for which the function calculates the coordinate conversion.

- scalar

Specify difference-time value to calculate ECI coordinates.

- one-dimensional array

Specify a one-dimensional array with *M* elements of difference time values, where *M* is the number of ECI coordinates. Each row corresponds to one set of ECI coordinates.

Specify 0.234 seconds as the difference between UTC and UT1.

Example: 0.234

Data Types: double

### **polarmotion — Polar displacement**

*M*-by-2 array of zeroes (default) | 1-by-2 array | *M*-by-2 array

Polar displacement of the Earth, in radians, from the motion of the Earth crust, along the *x*- and *y*-axes.

- 1-by-2 array

Specify a 1-by-2 array of the polar displacement values to convert one ECI coordinate.

- *M*-by-2 array

Specify an *M*-by-2 array of polar displacement values, where *M* is the number of ECI coordinates to convert. Each row corresponds to one set of UTC values.

Example: [-0.0682e-5 0.1616e-5]

Data Types: double

## **Name-Value Pair Arguments**

Specify optional comma-separated pairs of **Name**, **Value** arguments. **Name** is the argument name and **Value** is the corresponding value. **Name** must appear inside single



quotes (' '). You can specify several name and value pair arguments in any order as `Name1, Value1, ..., NameN, ValueN`.

Example: `'dNutation', [-0.2530e-6 -0.0188e-6]`

**'dNutation' — Adjustment to longitude (*dDeltaPsi*) and obliquity (*dDeltaEpsilon*)**

*M*-by-2 array of zeroes (default) | *M*-by-2 array

Adjustment to the longitude (*dDeltaPsi*) and obliquity (*dDeltaEpsilon*), in radians, specified as the comma-separated pair consisting of `dNutation` and an *M*-by-2 array. You can use this Name, Value pair with the IAU-76/FK5 reduction.

For historical values, see the International Earth Rotation and Reference Systems Service website (<http://www.iers.org>) and navigate to the Earth Orientation Data Data/Products page.

- *M*-by-2 array

Specify *M*-by-2 array of adjustment values, where *M* is the number of LLA coordinates to be converted. Each row corresponds to one set of longitude and obliquity values.

Data Types: double

**'dCIP' — Adjustment to the location of the celestial intermediate pole (CIP)**

*M*-by-2 array of zeroes (default)

Adjustment to the location of the celestial intermediate pole (CIP), in radians, specified as the comma-separated pair consisting of `dCIP` and an *M*-by-2 array. This location (*dDeltaX*, *dDeltaY*) is along the *x*- and *y*- axes. You can use this argument with the IAU-200/2006 reduction.

For historical values, see the International Earth Rotation and Reference Systems Service website (<http://www.iers.org>) and navigate to the Earth Orientation Data Data/Products page.

- *M*-by-2 array

Specify *M*-by-2 array of location adjustment values, where *M* is the number of LLA coordinates to convert. Each row corresponds to one set of *dDeltaX* and *dDeltaY* values.

Example: `'dcip', [-0.2530e-5 -0.0188e-4]`

Data Types: `double`

### '**flattening**' — Custom ellipsoid planet

1-by-1 array

Custom ellipsoid planet defined by flattening.

Example: `1/290`

Data Types: `double`

### '**re**' — Custom planet ellipsoid radius

1-by-1 array

Custom planet ellipsoid radius, in meters.

Example: `60000`

Data Types: `double`

## See Also

### See Also

`dcmecei2ecef` | `ecef2lla` | `geoc2geod` | `geod2geoc` | `lla2ecef` | `lla2eci`

**Introduced in R2014a**

## fganimation (Aero.FlightGearAnimation)

Construct FlightGear animation object

### Syntax

```
h = fganimation  
h = Aero.FlightGearAnimation
```

### Description

`h = fganimation` and `h = Aero.FlightGearAnimation` construct a FlightGear animation object. The FlightGear animation object is returned to `h`.

### Examples

Construct a FlightGear animation object, `h`:

```
h = fganimation
```

### See Also

`Aero.FlightGearAnimation`

Introduced in R2007a

## findstartstoptimes (Aero.Body)

Return start and stop times of time series data

### Syntax

```
[tstart,tstop] = findstartstoptimes(h,tsdata)
[tstart,stop] = h.findstartstoptimes(tsdata)
```

### Description

[tstart,tstop] = findstartstoptimes(h,tsdata) and [tstart,stop] = h.findstartstoptimes(tsdata) return the start and stop times of time series data tsdata for the animation body object h.

### Examples

Find the start and stop times of the time series data, *tsdata*.

```
b=Aero.Body;
b.load('pa24-250_orange.ac','Ac3d');
tsdata = [ ...
    0, 1,1,1, 0,0,0; ...
    10 2,2,2, 1,1,1; ];
b.TimeSeriesSource = tsdata;
[tstart,tstop] = findstartstoptimes(b,tsdata);
```

### See Also

load

Introduced in R2007a

## findstartstoptimes (Aero.Node)

Return start and stop times for time series data

### Syntax

```
[tstart,tstop] = findstartstoptimes(h,tsdata)  
[tstart,stop] = h.findstartstoptimes(tsdata)
```

### Description

[tstart,tstop] = findstartstoptimes(h,tsdata) and [tstart,stop] = h.findstartstoptimes(tsdata) return the start and stop times of time series data tsdata for the virtual reality animation object h.

### Examples

Find the start and stop times of the time series data, `takeoffData`.

```
h = Aero.VirtualRealityAnimation;  
h.VRWorldFilename = [matlabroot,'/toolbox/aero/astdemos/asttkoff.wrl'];  
copyfile(h.VRWorldFilename,[tempdir,'asttkoff.wrl'],'f');  
h.VRWorldFilename = [tempdir,'asttkoff.wrl'];  
h.initialize();  
load takeoffData;  
h.Nodes{7}.TimeseriesSource = takeoffData;  
h.Nodes{7}.TimeseriesSourceType = 'StructureWith Time';  
[tstart,stop]=h.Nodes{7}.findstartstoptimes;
```

**Introduced in R2007b**

# flat2lla

Convert from flat Earth position to array of geodetic latitude, longitude, and altitude coordinates from

## Syntax

```
lla = flat2lla(flatearth_pos, llo, psio, href)
lla = flat2lla(flatearth_pos, llo, psio, href, ellipsoidModel)
lla = flat2lla(flatearth_pos, llo, psio, href, flattening,
equatorialRadius)
```

## Description

`lla = flat2lla(flatearth_pos, llo, psio, href)` estimates an array of geodetic coordinates, *lla*, from an array of flat Earth coordinates, *flatearth\_pos*. This function estimates the *lla* value with respect to a reference location that *llo*, *psio*, and *href* define.

`lla = flat2lla(flatearth_pos, llo, psio, href, ellipsoidModel)` estimates the coordinates for a specific ellipsoid planet.

`lla = flat2lla(flatearth_pos, llo, psio, href, flattening, equatorialRadius)` estimates the coordinates for a custom ellipsoid planet defined by *flattening* and *equatorialRadius*.

## Input Arguments

### **flatearth\_pos**

Flat Earth position coordinates, in meters.

### **llo**

Reference location, in degrees, of latitude and longitude, for the origin of the estimation and the origin of the flat Earth coordinate system.

**psio**

Angular direction of flat Earth  $x$ -axis (degrees clockwise from north), which is the angle in degrees used for converting flat Earth  $x$  and  $y$  coordinates to North and East coordinates.

**href**

Reference height from the surface of the Earth to the flat Earth frame with regard to the flat Earth frame, in meters.

**ellipsoidModel**

Specific ellipsoid planet model. This function supports only 'WGS84'.

**Default:** WGS84

**flattening**

Custom ellipsoid planet defined by flattening.

**equatorialRadius**

Planetary equatorial radius, in meters.

## Output Arguments

**lla**

$m$ -by-3 array of geodetic coordinates (latitude, longitude, and altitude), in [degrees, degrees, meters].

**Default:**

## Examples

Estimate latitude, longitude, and altitude at a specified coordinate:

```
lla = flat2lla( [ 4731 4511 120 ], [0 45], 5, -100)
```

```
lla =
    0.0391    45.0441   -20.0000
```

Estimate latitudes, longitudes, and altitudes at multiple coordinates, specifying the WGS84 ellipsoid model:

```
lla = flat2lla( [ 4731 4511 120; 0 5074 4498 ], [0 45], 5, -100, 'WGS84' )
lla =
    1.0e+003 *
    0.0000    0.0450   -0.0200
   -0.0000    0.0450   -4.3980
```

Estimate latitudes, longitudes, and altitudes at multiple coordinates, specifying a custom ellipsoid model:

```
f = 1/196.877360;
Re = 3397000;
lla = flat2lla( [ 4731 4511 120; 0 5074 4498 ], [0 45], 5, -100, f, Re )
lla =
    1.0e+003 *
    0.0001    0.0451   -0.0200
   -0.0000    0.0451   -4.3980
```

## Algorithms

The estimation begins by transforming the flat Earth  $x$  and  $y$  coordinates to North and East coordinates. The transformation has the form of

$$\begin{bmatrix} N \\ E \end{bmatrix} = \begin{bmatrix} \cos\psi & -\sin\psi \\ \sin\psi & \cos\psi \end{bmatrix} \begin{bmatrix} p_x \\ p_y \end{bmatrix}$$

where  $(\bar{\psi})$  is the angle in degrees clockwise between the  $x$ -axis and north.

To convert the North and East coordinates to geodetic latitude and longitude, the estimation uses the radius of curvature in the prime vertical ( $R_N$ ) and the radius of curvature in the meridian ( $R_M$ ). ( $R_N$ ) and ( $R_M$ ) are defined by the following relationships:



$$R_N = \frac{R}{\sqrt{1 - (2f - f^2) \sin^2 \mu_0}}$$

$$R_M = R_N \frac{1 - (2f - f^2)}{1 - (2f - f^2) \sin^2 \mu_0}$$

where  $(R)$  is the equatorial radius of the planet and  $(\bar{f})$  is the flattening of the planet.

Small changes in the latitude and longitude are approximated from small changes in the North and East positions by

$$d\mu = \text{atan} \left( \frac{1}{R_M} \right) dN$$

$$dt = \text{atan} \left( \frac{1}{R_N \cos \mu} \right) dE$$

The output latitude and longitude are the initial latitude and longitude plus the small changes in latitude and longitude.

$$\mu = \mu_0 + d\mu$$

$$t = t_0 + dt$$

The altitude is the negative flat Earth  $z$ -axis value minus the reference height ( $h_{ref}$ ).

$$h = -p_z - h_{ref}$$

## References

Etkin, B., *Dynamics of Atmospheric Flight*. New York: John Wiley & Sons, 1972.

Stevens, B. L., and F. L. Lewis, *Aircraft Control and Simulation*, 2nd ed. New York: John Wiley & Sons, 2003.

## **See Also**

lla2flat

**Introduced in R2011a**

# flowfanno

Fanno line flow relations

## Syntax

```
[mach, T, P, rho, velocity, P0, fanno] = flowfanno(gamma,
fanno_flow, mtype)
```

## Description

[*mach*, *T*, *P*, *rho*, *velocity*, *P0*, *fanno*] = flowfanno(*gamma*, *fanno\_flow*, *mtype*) returns an array for each Fanno line flow relation. This function calculates the arrays for a given set of specific heat ratios (*gamma*), and any one of the Fanno flow types. You select the Fanno flow type with *mtype*.

This function uses Fanno variables given by the following. *F* is the Fanno parameter given by  $F = f^*L/D$ . *f* is the friction coefficient. *L* is the length of constant area duct required to achieve sonic flow. *D* is the hydraulic diameter of the duct.

This function assumes that variables vary in one dimension only. It also assumes that the main mechanism for the change of flow variables is the change of cross-sectional area of the flow stream tubes.

If the temperature experiences large fluctuations, the perfect gas assumption might be invalid. If the stagnation temperature is above 1500 K, do not assume constant specific heats. In this case, the medium ceases to be a calorically perfect gas. Consider it a thermally perfect gas. See 2 for thermally perfect gas correction factors. If the temperature is so high that molecules dissociate and ionize (static temperature 5000 K for air), you cannot assume a perfect gas.

## Input Arguments

### **gamma**

Array of *N* specific heat ratios. *gamma* must be either a scalar or an array of *N* real numbers greater than 1. *gamma* must be a real, finite scalar greater than 1 for the

following input modes: subsonic total pressure ratio, supersonic total pressure ratio, subsonic Fanno parameter, and supersonic Fanno parameter.

### **fanno\_flow**

Array of real numerical values for one Fanno flow. This argument can be one of the following:

- Array of Mach numbers. *flow\_fanno* must be a scalar or an array of *N* real numbers greater than or equal to 0. If *flow\_fanno* and *gamma* are arrays, they must be the same size.

Use *flow\_fanno* with the *mtype* value 'mach'. Because 'mach' is the default of *mtype*, *mtype* is optional when this array is the input mode.

- Array of temperature ratios. The temperature ratio is the local static temperature over the reference static temperature for sonic flow. This array must be a scalar or array of *N* real numbers:

- Greater than or equal to 0 (as the Mach number approaches infinity)
- Less than or equal to  $(\gamma+1)/2$  (at Mach number equal 0)

Use *flow\_fanno* with *mtype* value 'temp'.

- Array of pressure ratios. The pressure ratio is the local static pressure over the reference static pressure for sonic flow. *flow\_fanno* must be a scalar or array of real numbers greater than or equal to 0. If *flow\_fanno* and *gamma* are arrays, they must be the same size.

Use *flow\_fanno* with *mtype* value 'pres'.

- Array of density ratios. The density ratio is the local density over the reference density for sonic flow. *flow\_fanno* must be a scalar or array of real numbers. These numbers must be greater than or equal to:

$\sqrt{(\gamma-1)/(\gamma+1)}$  (as the Mach number approaches infinity).

If *flow\_fanno* and *gamma* are arrays, they must be the same size.

Use *flow\_fanno* with *mtype* value 'dens'.

- Array of velocity ratios. The velocity ratio is the local velocity over the reference velocity for sonic flow. *flow\_fanno* must be a scalar or an array of *N* of real numbers:

- Greater than or equal to 0

- Less than or equal to  $\sqrt{(\gamma+1)/(\gamma-1)}$  (as the Mach number approaches infinity)

If *flow\_fanno* and *gamma* are both arrays, they must be the same size.

Use *flow\_fanno* with *mtype* value 'velo'.

- Scalar value of total pressure ratio. The total pressure ratio is the local total pressure over the reference total pressure for sonic flow. *flow\_fanno* must be greater than or equal to 1.

Use *flow\_fanno* with *mtype* values 'totalp' and 'totalpsup'.

- Scalar value for Fanno parameter. The Fanno parameter is  $\text{flow\_fanno} = fL/D$ . *f* is the friction coefficient. *L* is the length of constant area duct required to achieve sonic flow. *D* is the hydraulic diameter of the duct. In subsonic mode, *flow\_fanno* must be greater than or equal to 0. In supersonic mode, *flow\_fanno* must be:

- Greater than or equal to 0 (at Mach number equal 1)
- Less than or equal to  $(\gamma+1)/(2*\gamma)*\log((\gamma+1)/(\gamma-1))-1/\gamma$  (as Mach number approaches infinity)

Use *flow\_fanno* with *mtype* values 'fannosub' and 'fannosup'.

## **mtype**

Input mode for the type of Fanno flow in *fanno\_flow*.

Type	Description
'mach'	Default Mach number
'temp'	Temperature ratio
'pres'	Pressure ratio
'dens'	Density ratio
'velo'	Velocity ratio
'totalpsub'	Subsonic total pressure ratio
'totalpsup'	Supersonic total pressure ratio
'fannosub'	Subsonic Fanno parameter
'fannosup'	Supersonic Fanno parameter

## Output Arguments

All outputs are the same size as the array inputs. If there are no array inputs, all outputs are scalars.

### **mach**

Array of Mach numbers.

### **T**

Array of temperature ratios. The temperature ratio is the local static temperature over the reference static temperature for sonic flow.

### **P**

Array of pressure ratios. The pressure ratio is the local static pressure over the reference static pressure for sonic flow.

### **rho**

Array of density ratio. The density ratio is the local density over the reference density for sonic flow.

### **velocity**

Array of velocity ratios. The velocity ratio is the local velocity over the reference velocity for sonic flow.

### **P0**

Array of stagnation (total) pressure ratio. The total pressure ratio is the local total pressure over the reference total pressure for sonic flow.

### **fanno**

Array of Fanno parameters. The Fanno parameter is  $F = fL/D$ .  $f$  is the friction coefficient.  $L$  is the length of constant area duct required to achieve sonic flow.  $D$  is the hydraulic diameter of the duct.

## Examples

Calculate the Fanno line flow relations for air ( $\gamma = 1.4$ ) for subsonic Fanno parameter 1.2. The following returns scalar values for *mach*, *T*, *P*, *rho*, *velocity*, *P0*, and *fanno*.

```
[mach, T, P, rho, velocity, P0, fanno] = flowfanno(1.4, 1.2, 'fannosub')
```

Calculate the Fanno line flow relations for gases with specific heat ratios given in the following 1 x 4 row array for the Mach number 0.5. The following yields a 1 x 4 row array for *mach*, *T*, *P*, *rho*, *velocity*, *P0*, and *fanno*.

```
gamma = [1.3, 1.33, 1.4, 1.67];
[mach, T, P, rho, velocity, P0, fanno] = flowfanno(gamma, 0.5)
```

Calculate the Fanno line flow relations for a specific heat ratio of 1.4 and range of temperature ratios from 0.40 to 0.70 in increments of 0.10. The following returns a 4 x 1 column array for *mach*, *T*, *P*, *rho*, *velocity*, *P0*, and *fanno*.

```
[mach, T, P, rho, velocity, P0, fanno] = flowfanno(1.4, [1.1 1.2], 'temp')
```

Calculate the Fanno line flow relations for gases with specific heat ratio and velocity ratio combinations as shown. The following returns a 1 x 2 array for *mach*, *T*, *P*, *rho*, *velocity*, *P0*, and *fanno* each. The elements of each array correspond to the inputs element-wise.

```
gamma = [1.3, 1.4];
V = [0.53, 0.49];
[MACH, T, P, RHO, V, P0, F] = flowfanno(gamma, V, 'velo')
```

## References

1. James, J. E. A., *Gas Dynamics, Second Edition*, Allyn and Bacon, Inc, Boston, 1984.
2. *NACA Technical Report 1135*, 1953, National Advisory Committee on Aeronautics, Ames Research Staff, Moffett Field, Calif. Pages 667–671.

## See Also

[flowisentropic](#) | [flownormalshock](#) | [flowprandtlmeyer](#) | [flowrayleigh](#)

Introduced in R2010a

# flowisentropic

Isentropic flow ratios

## Syntax

$[mach, T, P, rho, area] = \text{flowisentropic}(\gamma, flow, mtype)$

## Description

$[mach, T, P, rho, area] = \text{flowisentropic}(\gamma, flow, mtype)$  returns an array. This array contains an isentropic flow Mach number (*mach*), temperature ratio (*T*), pressure ratio (*P*), density ratio (*rho*), and area ratio (*area*). This function calculates these arrays given a set of specific heat ratios (*gamma*), and any one of the isentropic flow types. You select the isentropic flow with *mtype*.

This function assumes that variables vary in one dimension only. It also assumes that the main mechanism for the change of flow variables is the change of cross-sectional area of the flow stream tubes.

This function assumes that the environment is a perfect gas. In the following instances, the function cannot assume a perfect gas environment. If there is a large change in either temperature or pressure without a proportionally large change in the other, the function cannot assume a perfect gas environment. . If the stagnation temperature is above 1500 K, do not assume that constant specific heats. In this case, the medium ceases to be a calorically perfect gas. Consider it a thermally perfect gas. See 2 for thermally perfect gas correction factors. If the temperature is so high that molecules dissociate and ionize (static temperature 5000 K for air), you cannot assume a calorically or thermally perfect gas.

## Input Arguments

### **gamma**

Array of *N* specific heat ratios. *gamma* must be a scalar or array of *N* real numbers greater than 1. For subsonic area ratio input mode and supersonic area ratio input mode, *gamma* must be a real, finite scalar greater than 1.



**flow**

Array of real numerical values for one of the isentropic flow relations. This argument can be one of the following:

- Array of Mach numbers. *flow* must be a scalar or an array of  $N$  real numbers greater than or equal to 0. If *flow* and *gamma* are arrays, they must be the same size.

Use *flow* with the *mtype* value '*mach*'. Because '*mach*' is the default of *mtype*, *mtype* is optional when this array is the input mode.

- Array of temperature ratios. The temperature ratio is the local static temperature over the stagnation temperature. *flow* must be a scalar or an array of real numbers:
  - Greater than or equal to 0 (as the Mach number approaches infinity)
  - Less than or equal to 1 (at Mach number equal 0)

If *flow* and *gamma* are both arrays, they must be the same size.

Use *flow* with *mtype* value '*temp*'.

- Array of pressure ratios. The pressure ratio is the local static pressure over the stagnation pressure. *flow* must be a scalar or an array of real numbers:
  - Greater than or equal to 0 (as the Mach number approaches infinity)
  - Less than or equal to 1 (at Mach number equal 0)

If *flow* and *gamma* are both arrays, they must be the same size.

Use *flow* with *mtype* value '*pres*'.

- Array of density ratios. The density ratio is the local density over the stagnation density. *flow* must be a scalar or an array of real numbers:
  - Greater than or equal to 0 (as the Mach number approaches infinity)
  - Less than or equal to 1 (at Mach number equal 0)

If *flow* and *gamma* are both arrays, they must be the same size.

Use *flow* with *mtype* value '*dens*'.

- Scalar value of area ratio. *flow* must be a real value greater than or equal to 1.

Use *flow* with *mtype* value '*sup*'.

**mtype**

Input mode for the isentropic flow in *flow*.

Type	Description
'mach'	Default. Mach number.
'temp'	Temperature ratio.
'pres'	Pressure ratio.
'dens'	Density ratio.
'sub'	Subsonic area ratio. The subsonic area ratio is the local subsonic stream tube area over the reference stream tube area for sonic conditions.
'sup'	Supersonic area ratio. The supersonic area ratio is the local supersonic stream tube area over the reference stream tube area for sonic conditions.

## Output Arguments

All outputs are the same size as the array inputs. If there are no array inputs, all outputs are scalars.

**mach**

Array of Mach numbers.

**T**

Array of temperature ratios. The temperature ratio is the local static temperature over the stagnation temperature.

**P**

Array of pressure ratios. The pressure ratio is the local static pressure over the stagnation pressure.

**rho**

Array of density ratios. The density ratio is the local density over the stagnation density.

## area

Array of area ratios. The area ratio is the local stream tube area over the reference stream tube area for sonic conditions.

## Examples

Calculate the isentropic flow relations for air ( $\gamma = 1.4$ ) for a design subsonic area ratio of 1.255. This example returns scalar values for *mach*, *T*, *P*, *rho*, and *area*.

```
[mach, T, P, rho, area] = flowisentropic(1.4, 1.255, 'sub')
```

Calculate the isentropic flow relations for gases with specific heat ratios given in the following 1 x 4 row array for the Mach number 0.5. This example following returns a 1 x 4 row array for *mach*, *T*, *P*, *rho*, and *area*.

```
gamma = [1.3, 1.33, 1.4, 1.67];
[mach, T, P, rho, area] = flowisentropic(gamma, 0.5)
```

Calculate the isentropic flow relations for a specific heat ratio of 1.4. Also calculate range of temperature ratios from 0.40 to 0.70 in increments of 0.10. This example returns a 4 x 1 column array for *mach*, *T*, *P*, *rho*, and *area*.

```
[mach, T, P, rho, area] = flowisentropic(1.4, (0.40:0.10:0.70)', 'temp')
```

Calculate the isentropic flow relations for gases with provided specific heat ratio and density ratio combinations. This example returns a 1 x 2 array for *mach*, *T*, *P*, *rho*, and *area* each. The elements of each vector correspond to the inputs element-wise.

```
gamma = [1.3, 1.4];
rho = [0.13, 0.9];
[mach, T, P, rho, area] = flowisentropic(gamma, rho, 'dens')
```

## References

1. James, J. E. A., *Gas Dynamics, Second Edition*, Allyn and Bacon, Inc, Boston, 1984.
2. *NACA Technical Report 1135*, 1953, National Advisory Committee on Aeronautics, Ames Research Staff, Moffett Field, Calif. Pages 667–671.

## See Also

[flownormalshock](#) | [flowprandtlmeyer](#) | [flowfanno](#) | [flowrayleigh](#)

**Introduced in R2010a**

# flownormalshock

Normal shock relations

## Syntax

```
[mach, T, P, rho, downstream_mach, P0, P1] = flownormalshock(gamma,  
normal_shock_relations, mtype)
```

## Description

[*mach*, *T*, *P*, *rho*, *downstream\_mach*, *P0*, *P1*] = flownormalshock(*gamma*, *normal\_shock\_relations*, *mtype*) produces an array for each normal shock relation (*normal\_shock\_relations*). This function calculates these arrays for a given set of specific heat ratios (*gamma*) and any one of the normal shock relations (*normal\_shock\_relations*). *mtype* selects the normal shock relations that *normal\_shock\_relations* represents. All ratios are downstream value over upstream value. Consider upstream to be before or ahead of the shock; downstream is after or behind the shock.

This function assumes that the medium is a calorically perfect gas. It assumes that the flow is frictionless and adiabatic. It assumes that the flow variables vary in one dimension only. It assumes that the main mechanism for the change of flow variables is the change of cross-sectional area of the flow stream tubes.

If the temperature experiences large fluctuations, the perfect gas assumption might be invalid. If the stagnation temperature is above 1500 K, do not assume constant specific heats. In this case, the medium ceases to be a calorically perfect gas. You must then consider it a thermally perfect gas. See 2 for thermally perfect gas correction factors. If the temperature is so high that molecules dissociate and ionize (static temperature 5000 K for air), you cannot assume a perfect gas.

## Input Arguments

### **gamma**

Array of  $N$  specific heat ratios. *gamma* must be either a scalar or an array of  $N$  real numbers greater than 1. For temperature ratio, total pressure ratio, and Rayleigh-Pitot ratio input modes, *gamma* must be a real, finite scalar greater than 1.

### **normal\_shock\_relations**

Array of real numerical values for one of the normal shock relations. This argument can be one of the following:

- Array of upstream Mach numbers. This array must be a scalar or an array of  $N$  real numbers greater than or equal to 1. If *normal\_shock\_relations* and *gamma* are arrays, they must be the same size.

Use *normal\_shock\_relations* with *mtype* value 'mach'. Because 'mach' is the default of *mtype*, *mtype* is optional when this array is the input mode.

- Scalar value of temperature ratio. The temperature ratio is the static temperature downstream of the shock over the static temperature upstream of the shock. *normal\_shock\_relations* must be a real scalar greater than or equal to 1.

Use *normal\_shock\_relations* with *mtype* value 'temp'.

- Array of pressure ratios. The pressure ratio is the static pressure downstream of the shock over the static pressure upstream of the shock. *normal\_shock\_relations* must be a scalar or array of real numbers greater than or equal to 1. If *normal\_shock\_relations* and *gamma* are arrays, they must be the same size.

Use *normal\_shock\_relations* with *mtype* value 'pres'.

- Array of density ratios. The density ratio is the density of the fluid downstream of the shock over the density upstream of the shock. *normal\_shock\_relations* must be a scalar or array of real numbers be:
  - Greater than or equal to 1 (at Mach number equal 1)
  - Less than or equal to  $(\gamma+1)/(\gamma-1)$  (as the Mach number approaches infinity)

If *normal\_shock\_relations* and *gamma* are arrays, they must be the same size. Use *normal\_shock\_relations* with *mtype* value 'dens'.

- Array of downstream Mach numbers. *normal\_shock\_relations* must be scalar or array of real numbers:
  - Greater than or equal to 0 (as the Mach number approaches infinity)
  - Less than or equal to  $\sqrt{(\gamma-1)/(2*\gamma)}$  (at Mach number equal 1)

If *normal\_shock\_relations* and *gamma* are arrays, they must be the same size. Use *normal\_shock\_relations* with *mtype* value 'down'.

- Scalar value of total pressure ratio. The total pressure ratio is the total pressure downstream of the shock over the total pressure upstream of the shock. *normal\_shock\_relations* must be:
  - Greater than or equal to 0 (as the Mach number approaches infinity)
  - Less than or equal to 1 (at Mach number equal 1)

If *normal\_shock\_relations* and *gamma* are both arrays, they must be the same size. Use *normal\_shock\_relations* with *mtype* value 'totalp'.

- Scalar value of Rayleigh-Pitot ratio. The Rayleigh-Pitot ratio is the static pressure upstream of the shock over the total pressure downstream of the shock. *normal\_shock\_relations* must be:
  - Real scalar greater than or equal to 0 (as the Mach number approaches infinity)
  - Less than or equal to  $((\gamma+1)/2)^{-\gamma/(\gamma-1)}$  (at Mach number equal 1)

If *normal\_shock\_relations* and *gamma* are both arrays, they must be the same size. Use *normal\_shock\_relations* with *mtype* value 'pito'.

**mtype**

Input mode for the normal shock relations in *normal\_shock\_relations*.

Type	Description
'mach'	Default. Mach number.
'temp'	Temperature ratio.
'pres'	Pressure ratio.
'dens'	Density ratio.
'velo'	Velocity ratio.

Type	Description
'totalp'	Total pressure ratio.
'pito'	Rayleigh-Pitot ratio.

## Output Arguments

### **mach**

Array of upstream Mach numbers.

### **P**

Array of pressure ratios. The pressure ratio is the static pressure downstream of the shock over the static pressure upstream of the shock.

### **T**

Array of temperature ratios. The temperature ratio is the static temperature downstream of the shock over the static temperature upstream of the shock.

### **rho**

Array of density ratios. The density ratio is the density of the fluid downstream of the shock over the density upstream of the shock.

### **downstream\_mach**

Array of downstream Mach numbers.

### **P0**

Array of total pressure ratios. The total pressure ratio is the total pressure downstream of the shock over the total pressure upstream of the shock.

### **P1**

Array of Rayleigh-Pitot ratios. The Rayleigh-Pitot ratio is the static pressure upstream of the shock over the total pressure downstream of the shock.



## Examples

Calculate the normal shock relations for air ( $\gamma = 1.4$ ) for total pressure ratio of 0.61. The following returns scalar values for *mach*, *T*, *P*, *rho*, *downstream\_mach*, *P0*, and *P1*.

```
[mach, T, P, rho, downstream_mach, P0, P1] = flownormalshock(1.4, 0.61, 'total')
```

Calculate the normal shock relations for gases with specific heat ratios given in the following 1 x 4 row array for upstream Mach number 1.5. The follow yields a 1 x 4 array for *mach*, *T*, *P*, *rho*, *downstream\_mach*, *P0*, and *P1*.

```
gamma = [1.3, 1.33, 1.4, 1.67];
[mach, T, P, rho, downstream_mach, P0, P1] = flownormalshock(gamma, 1.5)
```

Calculate the normal shock relations for a specific heat ratio of 1.4 and range of density ratios from 2.40 to 2.70 in increments of 0.10. The following returns a 4 x 1 column array for *mach*, *T*, *P*, *rho*, *downstream\_mach*, *P0*, and *P1*.

```
[mach, T, P, rho, downstream_mach, P0, P1] = flownormalshock(1.4,...
(2.4:.1:2.7)', 'dens')
```

Calculate the normal shock relations for gases with specific heat ratio and downstream Mach number combinations as shown. The following example returns a 1 x 2 array for *mach*, *T*, *P*, *rho*, *downstream\_mach*, *P0*, and *P1* each, where the elements of each vector corresponds to the inputs element-wise.

```
gamma = [1.3, 1.4];
downstream_mach = [.34, .49];
[mach, T, P, rho, downstream_mach, P0, P1] = flownormalshock(gamma,...
downstream_mach, 'down')
```

## References

1. James, J. E. A., *Gas Dynamics, Second Edition*, Allyn and Bacon, Inc, Boston, 1984.
2. *NACA Technical Report 1135*, 1953, National Advisory Committee on Aeronautics, Ames Research Staff, Moffett Field, Calif. Pages 667–671.

## See Also

flowisentropic | flowprandtlmeyer | flowfanno | flowrayleigh

Introduced in R2010a

## flowprandtlmeyer

Calculate Prandtl-Meyer functions for expansion waves

### Syntax

```
[mach, nu, mu] = flowprandtlmeyer(gamma, prandtlmeyer_array, mtype)
```

### Description

[*mach*, *nu*, *mu*] = flowprandtlmeyer(*gamma*, *prandtlmeyer\_array*, *mtype*) calculates the following: array of Mach numbers, *mach*, Prandtl-Meyer angles (*nu* in degrees) and Mach angles (*mu* in degrees). flowprandtlmeyer calculates these arrays for a given set of specific heat ratios, *gamma*, and any one of the Prandtl-Meyer types. You select the Prandtl-Meyer type with *mtype*.

The function assumes that the flow is two-dimensional. The function also assumes a smooth and gradual change in flow properties through the expansion fan.

Note, this function assumes that the environment is a perfect gas. In the following instances, it cannot assume a perfect gas environment. If there is a large change in either temperature or pressure without a proportionally large change in the other, it cannot assume a perfect gas environment. If the stagnation temperature is above 1500 K, the function cannot assume constant specific heats. In this case, you must consider it a thermally perfect gas. See 2 for thermally perfect gas correction factors. The local static temperature might be so high that molecules dissociate and ionize (static temperature 5000 K for air). In this case, you cannot assume a calorically or thermally perfect gas.

### Input Arguments

#### **gamma**

Array of *N* specific heat ratios. *gamma* must be a scalar or array of *N* real numbers greater than 1. For subsonic area ratio input mode and supersonic area ratio input mode, *gamma* must be a real, finite scalar greater than 1.

**prandtlmeyer\_array**

Array of real numerical values for one of the Prandtl-Meyer types. This argument can be one of the following:

- Array of Mach numbers. This array must be a scalar or an array of  $N$  real numbers greater than or equal to 0. If *prandtlmeyer\_array* and *gamma* are arrays, they must be the same size.

Use *prandtlmeyer\_array* with *mtype* value 'mach'. Note, because 'mach' is the default of *mtype*, *mtype* is optional when this array is the input mode.

- Scalar value for Prandtl-Meyer angle in degrees. This value is the angle change required for a Mach 1 flow to achieve a given Mach number after expansion.

*prandtlmeyer\_array* must be:

- Real scalar greater than or equal to 0 (at Mach number equal 1)
- Less than or equal to  $90 * (\sqrt{(\gamma+1)/(\gamma-1)} - 1)$  (as the Mach number approaches infinity).

Use *prandtlmeyer\_array* with *mtype* value 'nu'.

- Array of Mach angles in degrees. These values are the angles between the flow direction and the lines of pressure disturbance caused by supersonic motion. The Mach angle is a function of Mach number only. *prandtlmeyer\_array* must be a scalar or array of  $N$  real numbers that are:

- Greater than or equal to 0 (as the Mach number approaches infinity).
- Less than or equal to 90 (at Mach number equal 1).

Use *prandtlmeyer\_array* with *mtype* value 'mu'.

**mtype**

Isentropic flow variable represented by *prandtlmeyer\_array*.

Type	Description
'mach'	Default. Mach number..
'nu'	Prandtl-Meyer angle
'mu'	Mach angle.

## Output Arguments

### ***mach***

Array of Mach numbers. In Prandtl-Meyer angle input mode, *mach* outputs are the same size as the array input or array inputs. If there are no array inputs, *mach* is a scalar.

### ***nu***

Array of Prandtl-Meyer angles. The Prandtl-Meyer angle is the angle change required for a Mach 1 flow to achieve a given Mach number after expansion.

### ***mu***

Array of Mach angles. The Mach angle is between the flow direction and the lines of pressure disturbance caused by supersonic motion.

## Examples

Calculate the Prandtl-Meyer relations for air (*gamma* = 1.4) for Prandtl-Meyer angle 61 degrees. The following returns a scalar for *mach*, *nu*, and *mu*.

```
[mach, nu, mu] = flowprandtlmeyer(1.4, 61, 'nu')
```

Calculate the Prandtl-Meyer functions for gases with specific heat ratios. The following yields a 1 x 4 array for *nu*, but only a scalar for *mach* and *mu*.

```
gamma = [1.3, 1.33, 1.4, 1.67];  
[mach, nu, mu] = flowprandtlmeyer(gamma, 1.5)
```

Calculate the Prandtl-Meyer angles for a specific heat ratio of 1.4 and range of Mach angles from 40 degrees to 70 degrees. This example uses increments of 10 degrees. The following returns a 4 x 1 column array for *mach*, *nu*, and *mu*.

```
[mach, nu, mu] = flowprandtlmeyer(1.4, (40:10:70)', 'mu')
```

Calculate the Prandtl-Meyer relations for gases with specific heat ratio and Mach number combinations as shown. The following returns a 1 x 2 array for *nu* and *mu* each, where the elements of each vector correspond to the inputs element-wise.

```
gamma = [1.3, 1.4];
```

```
prandtlmeyer_array = [1.13, 9];  
[mach, nu, mu] = flowprandtlmeyer(gamma,prandtlmeyer_array)
```

## References

1. James, J. E. A., *Gas Dynamics, Second Edition*, Allyn and Bacon, Inc, Boston, 1984.
2. *NACA Technical Report 1135*, 1953, National Advisory Committee on Aeronautics, Ames Research Staff, Moffett Field, Calif. Pages 667–671.

## See Also

[flowisentropic](#) | [flownormalshock](#) | [flowrayleigh](#) | [flowfanno](#)

**Introduced in R2010a**

## flowrayleigh

Rayleigh line flow relations

### Syntax

```
[mach, T, P, rho, velocity, T0, P0] = flowrayleigh(gamma,  
rayleigh_flow, mtype)
```

### Description

[*mach*, *T*, *P*, *rho*, *velocity*, *T0*, *P0*] = flowrayleigh(*gamma*, *rayleigh\_flow*, *mtype*) returns an array for each Rayleigh line flow relation. This function calculates these arrays for a given set of specific heat ratios (*gamma*), and any one of the Rayleigh line flow types. You select the Rayleigh flow type with *mtype*.

This function assumes that the medium is a calorically perfect gas in a constant area duct. It assumes that the flow is steady, frictionless, and one dimensional. It also assumes that the main mechanism for the change of flow variables is heat transfer.

This function assumes that the environment is a perfect gas. In the following instances, it cannot assume a perfect gas environment. If there is a large change in either temperature or pressure without a proportionally large change in the other, it cannot assume a perfect gas environment. If the stagnation temperature is above 1500 K, do not assume constant specific heats. In this case, the medium ceases to be a calorically perfect gas; you must then consider it a thermally perfect gas. See 2 for thermally perfect gas correction factors. The local static temperature might be so high that molecules dissociate and ionize (static temperature 5000 K for air). In this case, you cannot assume a calorically or thermally perfect gas.

### Input Arguments

#### **gamma**

Array of *N* specific heat ratios. *gamma* must be either a scalar or an array of *N* real numbers greater than 1. *gamma* must be a real, finite scalar greater than 1 for the

following input modes: low speed temperature ratio, high speed temperature ratio, subsonic total temperature, supersonic total temperature, subsonic total pressure, and supersonic total pressure.

### **rayleigh\_flow**

Array of real numerical values for one Rayleigh line flow. This argument can be one of the following:

- Array of Mach numbers. This array must be a scalar or an array of  $N$  real numbers greater than or equal to 0. If *rayleigh\_flow* and *gamma* are arrays, they must be the same size.

Use *rayleigh\_flow* with *mtype* value 'mach'. Because 'mach' is the default of *mtype*, *mtype* is optional when this array is the input mode.

- Scalar value of temperature ratio. The temperature ratio is the local static temperature over the reference static temperature for sonic flow. *rayleigh\_flow* must be a real scalar:

- Greater than or equal to 0 (at the Mach number equal 0 for low speeds or as Mach number approaches infinity for high speeds)
- Less than or equal to  $1/4*(\gamma+1/\gamma)+1/2$  (at  $mach = 1/\sqrt{\gamma}$ )

Use *rayleigh\_flow* with *mtype* values 'templo' and 'temphi'.

- Array of pressure ratios. The pressure ratio is the local static pressure over the reference static pressure for sonic flow. *rayleigh\_flow* must be a scalar or array of real numbers less than or equal to  $\gamma+1$  (at the Mach number equal 0). If *rayleigh\_flow* and *gamma* are arrays, they must be the same size.

Use *rayleigh\_flow* with *mtype* value 'pres'.

- Array of density ratios. The density ratio is the local density over the reference density for sonic flow. *rayleigh\_flow* must be a scalar or array of real numbers. These numbers must be greater than or equal to:

$\gamma/(\gamma+1)$  (as Mach number approaches infinity)

If *rayleigh\_flow* and *gamma* are arrays, they must be the same size.

Use *rayleigh\_flow* with *mtype* value 'dens'.

- Array of velocity ratios. The velocity ratio is the local velocity over the reference velocity for sonic flow. *rayleigh\_flow* must be a scalar or an array of  $N$  real numbers:
  - Greater than or equal to 0
  - Less than or equal to  $(\gamma+1)/\gamma$  (as Mach number approaches infinity)

If *rayleigh\_flow* and  $\gamma$  are both arrays, they must be the same size.

Use *rayleigh\_flow* with *mtype* value 'velo'.

- Scalar value of total temperature ratio. The total temperature ratio is the local stagnation temperature over the reference stagnation temperature for sonic flow. In subsonic mode, *rayleigh\_flow* must be a real scalar:
  - Greater than or equal to 0 (at the Mach number equal 0)
  - Less than or equal to 1 (at the Mach number equal 1)

In supersonic mode, *rayleigh\_flow* must be a real scalar:

- Greater than or equal to  $(\gamma+1)^{2\gamma} / (\gamma+1)^{2\gamma}$  (as Mach number approaches infinity)
- Less than or equal to 1 (at the Mach number equal 1)

Use *rayleigh\_flow* with the *mtype* values 'totaltsub' and 'totaltsup'.

- Scalar value of total pressure ratio. The total pressure ratio is the local stagnation pressure over the reference stagnation pressure for sonic flow. In subsonic mode, *rayleigh\_flow* must be a real scalar.
  - Greater than or equal to 1 (at the Mach number equal 1)
  - Less than or equal to  $(1+\gamma)^{-1} (1+\gamma/2)^{\gamma}$  (at Mach number equal 0)

In supersonic mode, *rayleigh\_flow* must be a real scalar greater than or equal to 1.

Use *rayleigh\_flow* with *mtype* values 'totalpsub' and 'totalpsup'.

### **mtype**

Input mode for the Rayleigh flow in *rayleigh\_flow*.



Type	Description
'mach'	Default. Mach number.
'templo'	Low speed static temperature ratio. The low speed temperature ratio is the local static temperature over the reference sonic temperature. This ratio for when the Mach number of the upstream flow is less than the critical Mach number of $1/\sqrt{\gamma}$ .
'temphi'	High speed static temperature ratio. The high speed temperature ratio is the local static temperature over the reference sonic temperature. This ratio is for when the Mach number of the upstream flow is greater than the critical Mach number of $1/\sqrt{\gamma}$ .
'pres'	Pressure ratio.
'dens'	Density ratio.
'velo'	Velocity ratio.
'totaltsub'	Subsonic total temperature ratio.
'totaltsup'	Supersonic total temperature ratio.
'totalpsub'	Subsonic total pressure ratio.
'totalpsup'	Supersonic total pressure ratio.

## Output Arguments

All output ratios are static conditions over the sonic conditions. All outputs are the same size as the array inputs. If there are no array inputs, all outputs are scalars.

### **mach**

Array of Mach numbers.

### **T**

Array of temperature ratios. The temperature ratio is the local static temperature over the reference static temperature for sonic flow.

### **P**

Array of pressure ratios. The pressure ratio is the local static pressure over the reference static pressure for sonic flow.

### **rho**

Array of density ratio. The density ratio is the local density over the reference density for sonic flow.

### **velocity**

Array of velocity ratios. The velocity ratio is the local velocity over the reference velocity for sonic flow.

### **T0**

Array of total temperature ratios. The temperature ratio is the local stagnation temperature over the reference stagnation temperature for sonic flow.

### **P0**

Array of total pressure ratios. The total pressure ratio is the local stagnation pressure over the reference stagnation pressure for sonic flow.

## **Examples**

### **Calculate Rayleigh Line Flow Relations Given Air**

Calculate the Rayleigh line flow relations for air ( $\gamma = 1.4$ ) for supersonic total pressure ratio 1.2.

```
[mach,T,P,rho,velocity,T0,P0] = flowrayleigh(1.4,1.2,'totalpsup')
```

```
mach =
```

```
    1.6397
```

```
T =
```

```
    0.6823
```

```
P =
```

```
    0.5038
```

```
rho =
```

```

    0.7383
velocity =
    1.3545
T0 =
    0.8744
P0 =
    1.2000

```

This example returns scalar values for *mach*, *T*, *P*, *rho*, *velocity*, *T0*, and *P0*.

### Calculate Rayleigh Line Flow Relations for Specific Heat Ratios in Array

Calculate the Rayleigh line flow relations for gases with specific heat ratios given in the following 1 x 4 row array for the Mach number 0.5.

```

gamma = [1.3,1.33,1.4,1.67];
[mach,T,P,rho,velocity,T0,P0] = flowrayleigh(gamma,0.5)

mach =

    0.5000    0.5000    0.5000    0.5000

T =

    0.7533    0.7644    0.7901    0.8870

P =

    1.7358    1.7486    1.7778    1.8836

rho =

    2.3043    2.2876    2.2500    2.1236

velocity =

    0.4340    0.4371    0.4444    0.4709

T0 =

```

```
    0.6796    0.6832    0.6914    0.7201
P0 =
    1.1111    1.1121    1.1141    1.1202
```

This example returns a 1 x 4 row array for *mach*, *T*, *P*, *rho*, *velocity*, *T0*, and *P0*.

### Calculate Rayleigh Line Flow Relations for Specific Heat Ratios and High Speed Temperature

Calculate the Rayleigh line flow relations for a specific heat ratio of 1.4 and high speed temperature ratio 0.70.

```
[mach,T,P,rho,velocity,T0,P0] = flowrayleigh(1.4,0.70,'temphi')
```

```
mach =
    1.6035
T =
    0.7000
P =
    0.5218
rho =
    0.7454
velocity =
    1.3416
T0 =
    0.8833
P0 =
    1.1777
```

This example returns scalar values for *mach*, *T*, *P*, *rho*, *velocity*, *T0*, and *P0*.

### Calculate Rayleigh Line Flow Relations for Gases with Specific Heat Ratio and Static Pressure

Calculate the Rayleigh line flow relations for gases with specific heat ratio and static pressure ratio combinations as shown.

```
gamma = [1.3,1.4];  
P = [0.13,1.7778];  
[mach,T,P,rho,velocity,T0,P0] = flowrayleigh(gamma,P,'pres')
```

mach =

```
3.5833    0.5000
```

T =

```
0.2170    0.7901
```

P =

```
0.1300    1.7778
```

rho =

```
0.5991    2.2501
```

velocity =

```
1.6692    0.4444
```

T0 =

```
0.5521    0.6913
```

P0 =

```
7.4381    1.1141
```

This example returns a 1 x 2 array for *mach*, *T*, *P*, *rho*, *velocity*, *T0*, and *P0* each. The elements of each array correspond to the inputs element-wise.

## References

1. James, J. E. A., *Gas Dynamics, Second Edition*, Allyn and Bacon, Inc, Boston, 1984.
2. *NACA Technical Report 1135*, 1953, National Advisory Committee on Aeronautics, Ames Research Staff, Moffett Field, Calif. Pages 667–671.

## See Also

`flowisentropic` | `flownormalshock` | `flowprandtlmeyer` | `flowfanno`

**Introduced in R2010a**

## generatePatches (Aero.Body)

Generate patches for body with loaded face, vertex, and color data

### Syntax

```
generatePatches(h, ax)  
h.generatePatches(ax)
```

### Description

`generatePatches(h, ax)` and `h.generatePatches(ax)` generate patches for the animation body object `h` using the loaded face, vertex, and color data in `ax`.

### Examples

Generate patches for `b` using the axes, `ax`.

```
b=Aero.Body;  
b.load('pa24-250_orange.ac', 'Ac3d');  
f = figure;  
ax = axes;  
b.generatePatches(ax);
```

### See Also

`load`

Introduced in R2007a

## GenerateRunScript (Aero.FlightGearAnimation)

Generate run script for FlightGear flight simulator

### Syntax

```
GenerateRunScript(h)  
h.GenerateRunScript
```

### Description

GenerateRunScript(h) and h.GenerateRunScript generate a run script for FlightGear flight simulator using the following FlightGear animation object properties:

OutputFileName	Specify the name of the output file. The file name is the name of the command you will use to start FlightGear with these initial parameters. The default value is 'runfg.bat'.
FlightGearBaseDirectory	Specify the name of your FlightGear installation folder. The default value is 'D:\Applications\FlightGear'.
GeometryModelName	Specify the name of the folder containing the desired model geometry in the <i>FlightGear\data\Aircraft</i> folder. The default value is 'HL20'.
DestinationIpAddress	Specify your destination IP address. The default value is '127.0.0.1'.
DestinationPort	Specify your network flight dynamics model (fdm) port. This destination port should be an unused port that you can use when you launch FlightGear. The default value is '5502'.
AirportId	Specify the airport ID. The list of supported airports is available in the FlightGear interface, under <b>Location</b> . The default value is 'KSFO'.
RunwayId	Specify the runway ID. The default value is '10L'.
InitialAltitude	Specify the initial altitude of the aircraft, in feet. The default value is 7224 feet.



<b>InitialHeading</b>	Specify the initial heading of the aircraft, in degrees. The default value is 113 degrees.
<b>OffsetDistance</b>	Specify the offset distance of the aircraft from the airport, in miles. The default value is 4.72 miles.
<b>OffsetAzimuth</b>	Specify the offset azimuth of the aircraft, in degrees. The default value is 0 degrees.
<b>Architecture</b>	Specify the architecture on which the FlightGear software is running.

## Examples

Create a run script, `runfg.bat`, to start FlightGear flight simulator using the default object settings:

```
h = fanimation
GenerateRunScript(h)
```

Create a run script, `myscript.bat`, to start FlightGear flight simulator using the default object settings:

```
h = fanimation
h.OutputFileName = 'myscript.bat'
GenerateRunScript(h)
```

## See Also

`play` | `initialize` | `update`

**Introduced in R2007a**

# geoc2geod

Convert geocentric latitude to geodetic latitude

## Syntax

```
geodeticLatitude = geoc2geod(geocentricLatitude, radii)  
geodeticLatitude = geoc2geod(geocentricLatitude, radii, model)  
geodeticLatitude = geoc2geod(geocentricLatitude, radii, flattening,  
equatorialRadius)
```

## Description

*geodeticLatitude* = geoc2geod(*geocentricLatitude*, *radii*) converts an array of *m*-by-1 geocentric latitudes and an array of radii from the center of the planet into an array of *m*-by-1 geodetic latitudes.

*geodeticLatitude* = geoc2geod(*geocentricLatitude*, *radii*, *model*) converts for a specific ellipsoid planet.

*geodeticLatitude* = geoc2geod(*geocentricLatitude*, *radii*, *flattening*, *equatorialRadius*) converts for a custom ellipsoid planet defined by flattening and the equatorial radius.

The function uses geometric relationships to calculate the geodetic latitude in this noniterative method.

This function has the limitation that this implementation generates a geodetic latitude that lies between  $\pm 90$  degrees.

## Input Arguments

### **geocentricLatitude**

Array of *m*-by-1 geocentric latitudes, in degrees. Latitude values can be any value. However, values of +90 and -90 may return unexpected values because of singularity at the poles.

**radii**

Array of radii from the center of the planet, in meters.

**model**

Specific ellipsoid planet. This function supports only 'WGS84'.

**flattening**

Custom ellipsoid planet defined by flattening.

**equatorialRadius**

Equatorial radius, in meters.

## Output Arguments

**geodeticLatitude**

Array of  $m$ -by-1 geodetic latitudes, in degrees.

## Examples

Determine geodetic latitude given a geocentric latitude and radius:

```
gd = geoc2geod(45, 6379136)
```

```
gd =
```

```
    45.1921
```

Determine geodetic latitude at multiple geocentric latitudes, given a radius, and specifying WGS84 ellipsoid model:

```
gd = geoc2geod([0 45 90], 6379136, 'WGS84')
```

```
gd =
```

```
0 45.1921 90.0000
```

Determine geodetic latitude at multiple geocentric latitudes, given a radius, and specifying custom ellipsoid model:

```
f = 1/196.877360;  
Re = 3397000;  
gd = geoc2geod([0 45 90], 6379136, f, Re)
```

```
gd =
```

```
0 45.1550 90.0000
```

## References

Jackson, E.B., *Manual for a Workstation-based Generic Flight Simulation Program (LaRCsim) Version 1.4*, NASA TM 110164, April 1995

Hedgley, D. R., Jr., *An Exact Transformation from Geocentric to Geodetic Coordinates for Nonzero Altitudes*, NASA TR R-458, March, 1976

Clynch, J. R., *Radius of the Earth — Radii Used in Geodesy*, Naval Postgraduate School, 2002, <http://www.oc.nps.edu/oc2902w/geodesy/radiigeo.pdf>

Stevens, B. L., and F. L. Lewis, *Aircraft Control and Simulation*, John Wiley & Sons, New York, NY, 1992

Edwards, C. H., and D. E. Penny, *Calculus and Analytical Geometry*, 2nd Edition, Prentice-Hall, Englewood Cliffs, NJ, 1986

## See Also

`geod2geoc` | `ecef211a` | `11a2ecef`

**Introduced in R2006b**

# geocradius

Convert from geocentric latitude to radius of ellipsoid planet

## Syntax

```
r = geocradius(lambda)
r = geocradius(lambda, model)
r = geocradius(lambda, f, Re)
```

## Description

`r = geocradius(lambda)` estimates the radius, `r`, of an ellipsoid planet at a particular geocentric latitude, `lambda`. `lambda` is in degrees. `r` is in meters. The default ellipsoid planet is WGS84.

`r = geocradius(lambda, model)` is an alternate method for estimating the radius for a specific ellipsoid planet. Currently only 'WGS84' is supported for `model`.

`r = geocradius(lambda, f, Re)` is another alternate method for estimating the radius for a custom ellipsoid planet defined by flattening, `f`, and the equatorial radius, `Re`, in meters.

## Examples

Determine radius at 45 degrees latitude:

```
r = geocradius(45)
```

```
r =
```

```
6.3674e+006
```

Determine radius at multiple latitudes:

```
r = geocradius([0 45 90])
```

r =

```
1.0e+006 *  
6.3781 6.3674 6.3568
```

Determine radius at multiple latitudes, specifying WGS84 ellipsoid model:

```
r = geocradius([0 45 90], 'WGS84')
```

r =

```
1.0e+006 *  
6.3781 6.3674 6.3568
```

Determine radius at multiple latitudes, specifying custom ellipsoid model:

```
f = 1/196.877360;  
Re = 3397000;  
r = geocradius([0 45 90], f, Re)
```

r =

```
1.0e+006 *  
3.3970 3.3883 3.3797
```

## References

Stevens, B. L., and F. L. Lewis, *Aircraft Control and Simulation*, John Wiley & Sons, New York, NY, 1992

Zipfel, P. H., and D. E. Penny, *Modeling and Simulation of Aerospace Vehicle Dynamics*, AIAA Education Series, Reston, VA, 2000

## See Also

geoc2geod | geod2geoc

**Introduced in R2006b**

# geod2geoc

Convert geodetic latitude to geocentric latitude

## Syntax

```
gc = geod2geoc(gd, h)
gc = geod2geoc(gd, h, model)
gc = geod2geoc(gd, h, f, Re)
```

## Description

`gc = geod2geoc(gd, h)` converts an array of  $m$  geodetic latitudes, `gd`, and an array of mean sea level altitudes, `h`, into an array of  $m$  geocentric latitudes, `gc`. `h` is in meters. Latitude values can be any value. However, values of +90 and -90 may return unexpected values because of singularity at the poles.

`gc = geod2geoc(gd, h, model)` is an alternate method for converting from geodetic to geocentric latitude for a specific ellipsoid planet. Currently only 'WGS84' is supported for `model`. Latitude values can be any value. However, values of +90 and -90 may return unexpected values because of singularity at the poles.

`gc = geod2geoc(gd, h, f, Re)` is another alternate method for converting from geodetic to geocentric latitude for a custom ellipsoid planet defined by flattening, `f`, and the equatorial radius, `Re`, in meters. Latitude values can be any value. However, values of +90 and -90 may return unexpected values because of singularity at the poles.

## Examples

Determine geocentric latitude given a geodetic latitude and altitude:

```
gc = geod2geoc(45, 1000)
```

```
gc =
```



```
44.8076
```

Determine geocentric latitude at multiple geodetic latitudes and altitudes, specifying WGS84 ellipsoid model:

```
gc = geod2geoc([0 45 90], [1000 0 2000], 'WGS84')
```

```
gc =
```

```
      0
44.8076
90.0000
```

Determine geocentric latitude at multiple geodetic latitudes, given an altitude and specifying custom ellipsoid model:

```
f = 1/196.877360;
Re = 3397000;
gc = geod2geoc([0 45 90], 2000, f, Re)
```

```
gc =
```

```
      0
44.7084
90.0000
```

## Assumptions and Limitations

This implementation generates a geocentric latitude that lies between  $\pm 90$  degrees.

## References

Stevens, B. L., and F. L. Lewis, *Aircraft Control and Simulation*, John Wiley & Sons, New York, NY, 1992

## See Also

geoc2geod | ecef2lla | lla2ecef

**Introduced in R2006b**

# geoidegm96

Calculate geoid height as determined from EGM96 Geopotential Model

---

**Note:** `geoidegm96` will be removed in a future version. Use `geoidheight` instead.

---

## Syntax

```
N = geoidegm96(lat, long)
N = geoidegm96(lat, long, action)
```

## Description

`N = geoidegm96(lat, long)` calculates the geoid height as determined from the EGM96 Geopotential Model. It calculates geoid heights to 0.01 meters. This function interpolates geoid heights from a 15-minute grid of point values in the tide-free system, using the EGM96 Geopotential Model to the degree and order 360. The geoid undulations are relative to the WGS84 ellipsoid.

`N = geoidegm96(lat, long, action)` calculates the geoid height as determined from the EGM96 Geopotential Model. This function performs `action` if `latitude` or `longitude` are out of range.

Inputs required by `geoidegm96`:

<code>lat</code>	An array of <code>m</code> geocentric latitudes, in degrees, where north latitude is positive and south latitude is negative. <code>lat</code> must be of type <code>single</code> or <code>double</code> . If <code>lat</code> is not within the range -90 to 90, inclusive, this function wraps the value to be within the range.
<code>long</code>	An array of <code>m</code> geocentric longitudes, in degrees, where east longitude is positive and west longitude is negative. <code>long</code> must be of type <code>single</code> or <code>double</code> . If <code>long</code> is not within the range 0 to 360 inclusive, this function wraps the value to be within the range.

**action** Action for out-of-range input. Specify if out-of-range input invokes a 'Warning', 'Error', or no action ('None'). The default is 'Warning'.

## Examples

Calculate the geoid height at 42.4 degrees N latitude and 71.0 degrees E longitude.

```
N = geoidgm96( 42.4, 71.0)
```

Calculate the geoid height at two different locations, with out-of-range actions generating warnings.

```
N = geoidgm96( [39.3,33.4], [-77.2, 36.5])
```

Calculate the geoid height with latitude wrapping, with out-of-range actions displaying no warnings.

```
N = geoidgm96(100,150,'None')
```

## Limitations

This function has the limitations of the 1996 Earth Geopotential Model. For more information, see <http://earth-info.nga.mil/GandG/wgs84/gravitymod/egm96/egm96.html>.

The WGS84 EGM96 geoid undulations have an error range of +/-0.5 to +/-1.0 meters worldwide.

## References

NIMA TR8350.2: "Department of Defense World Geodetic System 1984, Its Definition and Relationship with Local Geodetic Systems."

NASA/TP-1998-206861: "The Development of the Joint NASA GSFC and NIMA Geopotential Model EGM96"

National Geospatial-Intelligence Agency Website: <http://earth-info.nga.mil/GandG/wgs84/gravitymod/egm96/egm96.html>

## **See Also**

gravitywgs84

**Introduced in R2007b**

## geoidheight

Calculate geoid height

### Syntax

```
N = geoidheight(latitude,longitude)
N = geoidheight(latitude, longitude, modelname)
N = geoidheight(latitude, longitude, action)
N = geoidheight(latitude, longitude, modelname, action)
N = geoidheight(latitude, longitude, 'Custom', datafile)
N = geoidheight(latitude, longitude, 'Custom', datafile, action)
```

### Description

`N = geoidheight(latitude,longitude)` calculates the geoid height using the EGM96 Geopotential Model. For this model, it calculates these geoid heights to an accuracy of 0.01 m. It interpolates an array of  $m$  geoid heights at  $m$  geocentric latitudes, *latitude*, and  $m$  geocentric longitudes, *longitude*.

`N = geoidheight(latitude, longitude, modelname)` calculates the geoid height using the model, *modelName*.

`N = geoidheight(latitude, longitude, action)` calculates the geoid height using the EGM96 Geopotential Model. This function performs *action* if *latitude* or *longitude* are out of range.

`N = geoidheight(latitude, longitude, modelName, action)` calculates the geoid height using *modelName*.

`N = geoidheight(latitude, longitude, 'Custom', datafile)` calculates the geoid height using a custom model that *datafile* defines.

`N = geoidheight(latitude, longitude, 'Custom', datafile, action)` calculates the geoid height using the custom model. This function performs *action* if *latitude* or *longitude* are out of range.

## Input Arguments

### **latitude**

An array of  $m$  geocentric latitudes, in degrees, where north latitude is positive and south latitude is negative. *latitude* must be of type single or double. If *latitude* is not within the range  $-90$  to  $90$ , inclusive, this function wraps the value to be within the range.

### **Default:**

### **longitude**

An array of  $m$  geocentric longitudes, in degrees, where east longitude is positive and west longitude is negative. *longitude* must be of type single or double. If *longitude* is not within the range  $0$  to  $360$  inclusive, this function wraps the value to be within the range.

### **modelName**

Geopotential model.

Geopotential Model	Description
'EGM96'	EGM96 Geopotential Model to degree and order 360. This model uses a 15-minute grid of point values in the tide-free system. This function calculates geoid heights to an accuracy of 0.01 m for this model.
'EGM2008'	EGM2008 Geopotential Model to degree and order 2159. This model uses a 2.5-minute grid of point values in the tide-free system. This function calculates geoid heights to an accuracy of 0.001 m for this model.  <b>Note:</b> This function requires that you download EGM2008 Geopotential Model data with the Add-On Explorer. For more information, see <code>aeroDataPackage</code> .
'Custom'	Custom geopotential model that you define in <i>datafile</i> . This function calculates geoid heights to an accuracy of 0.01 m for custom models.

Geopotential Model	Description
	<p><b>Note:</b> To deploy a custom geopotential model, explicitly include the custom data and reader files to the MATLAB Compiler™ (mcc) command at compilation. For example:</p> <pre>mcc -m mycustomsgeoidheightfunction... -a customDataFile</pre> <p>For other geopotential models, use the MATLAB Compiler as usual.</p>

**Default:** EGM96

**datafile**

Optional file that contains definitions for a custom geopotential model. Provide this file only if you specify 'Custom' for the modelName argument.

This file must contain the following variables.

Variable	Description
'latbp'	Array of geocentric latitude breakpoints.
'lonbp'	Array of geocentric longitude breakpoints.
'grid'	Table of geoid height values.
'windowSize'	Even integer scalar greater than 2 for the number of interpolation points.

**action**

Action for out-of-range input. Specify one:

- 'Error'
- 'Warning'
- 'None'

**Default:** Warning



## Output Arguments

### N

An array of  $M$  geoid heights in meters. The values in this array have the same data type as *latitude*.

## Examples

Calculate the EGM96 geoid height at 42.4 degrees N latitude and 71.0 degrees W longitude with warning actions:

```
N = geoidheight( 42.4, -71.0 )
```

Calculate the EGM2008 geoid height at two different locations with error actions.

```
N = geoidheight( [39.3, 33.4], [77.2, 36.5], 'egm2008', ...  
'error')
```

Calculate a custom geoid height at two different locations with no actions.

```
N = geoidheight( [39.3, 33.4], [-77.2, 36.5], 'custom', ...  
'geoidegm96grid', 'none')
```

## Tips

- This function interpolates geoid heights from a grid of point values in the tide-free system.
- When using the EGM96 Model, this function has the limitations of the 1996 Earth Geopotential Model.
- When using the EGM2008 Model, this function has the limitations of the 2008 Earth Geopotential Model.
- The interpolation scheme wraps over the poles to allow for geoid height calculations at and near pole locations.
- The geoid undulations for the EGM96 and EGM2008 models are relative to the WGS84 ellipsoid.
- The WGS84 EGM96 geoid undulations have an error range of  $\pm 0.5$  to  $\pm 1.0$  m worldwide.

## References

Vallado, D. A. "Fundamentals of Astrodynamics and Applications." McGraw-Hill, New York, 1997.

NIMA TR8350.2: "Department of Defense World Geodetic System 1984, Its Definition and Relationship with Local Geodetic Systems."

## See Also

gravitywgs84 | gravitysphericalharmonic

## External Websites

National Geospatial-Intelligence Agency Web site: <http://earth-info.nga.mil/GandG/publications/vertdatum.html>

**Introduced in R2010b**

## **Geometry (Aero.Geometry)**

Construct 3-D geometry for use with animation object

### **Syntax**

`h = Aero.Geometry`

### **Description**

`h = Aero.Geometry` defines a 3-D geometry for use with an animation object.

See `Aero.Geometry` for further details.

### **See Also**

`Aero.Geometry`

**Introduced in R2007a**

# gravitycentrifugal

Implement centrifugal effect of planetary gravity

## Syntax

```
[gx gy gz] = gravitycentrifugal(planet_coordinates)  
[gx gy gz] = gravitycentrifugal(planet_coordinates, model )  
[gx gy gz] = gravitycentrifugal(planet_coordinates, 'Custom',  
rotational_rate)
```

## Description

[*gx gy gz*] = gravitycentrifugal(*planet\_coordinates*) implements the mathematical representation of centrifugal effect for planetary gravity based on planetary rotation rate. This function calculates arrays of *N* gravity values in the *x*-axis, *y*-axis, and *z*-axis of the Planet-Centered Planet-Fixed coordinates for the planet. It performs these calculations using *planet\_coordinates*, an *M*-by-3 array of Planet-Centered Planet-Fixed coordinates. You use centrifugal force in rotating or noninertial coordinate systems. Gravity centrifugal effect values are greatest at the equator of a planet.

[*gx gy gz*] = gravitycentrifugal(*planet\_coordinates*, *model* ) implements the mathematical representation of centrifugal effect based on planetary gravitational potential for the planetary model, *model*.

[*gx gy gz*] = gravitycentrifugal(*planet\_coordinates*, 'Custom', *rotational\_rate*) implements the mathematical representation of centrifugal effect based on planetary gravitational potential using the custom rotational rate, *rotational\_rate*.

## Input Arguments

### **planet\_coordinates**

$M$ -by-3 array of Planet-Centered Planet-Fixed coordinates in meters. The  $z$ -axis is positive toward the North Pole. If *model* is 'Earth', the planet coordinates are ECEF coordinates.

### **model**

Planetary model. Default is 'Earth'. Specify one:

- 'Mercury'
- 'Venus'
- 'Earth'
- 'Moon'
- 'Mars'
- 'Jupiter'
- 'Saturn'
- 'Uranus'
- 'Neptune'
- 'Custom'

'Custom' requires that you specify your own planetary model using the *rotational\_rate* parameter.

### **rotational\_rate**

Scalar value that specifies the planetary rotational rate in radians per second. Specify this parameter only if *model* has the value 'Custom'.

## Output Arguments

### **gx**

Array of  $M$  gravity values in the  $x$ -axis of the Planet-Centered Planet-Fixed coordinates in meters per second squared ( $m/s^2$ ).

**gy**

Array of  $M$  gravity values in the  $y$ -axis of the Planet-Centered Planet-Fixed coordinates in meters per second squared ( $\text{m/s}^2$ ).

**gz**

Array of  $M$  gravity values in the  $z$ -axis of the Planet-Centered Planet-Fixed coordinates in meters per second squared ( $\text{m/s}^2$ ).

## Examples

Calculate the centrifugal effect of Earth gravity in the  $x$ -axis at the equator on the surface of Earth:

```
gx = gravitycentrifugal( [-6378.1363e3 0 0] )
```

Calculate the centrifugal effect of Mars gravity at 15000 m over the equator and 11000 m over the North Pole:

```
p = [2412.648e3 -2412.648e3 0; 0 0 3376.2e3]  
[gx, gy, gz] = gravitycentrifugal( p, 'Mars' )
```

Calculate the precessing centrifugal effect of gravity for Earth at 15000 m over the equator and 11000 m over the North Pole. This example uses a custom planetary model at Julian date 2451545:

```
p          = [2412.648e3 -2412.648e3 0; 0 0 3376e3]  
% Set julian date to January 1, 2000 at noon GMT  
JD         = 2451545  
% Calculate precession rate in right ascension in meters  
pres_RA   = 7.086e-12 + 4.3e-15*(JD - 2451545)/36525  
% Calculate the rotational rate in a precessing reference  
% frame  
Omega     = 7.2921151467e-5 + pres_RA  
[gx, gy, gz] = gravitycentrifugal( p, 'custom', Omega )
```

## See Also

[gravitywgs84](#) | [gravitiesphericalharmonic](#) | [gravityzonal](#)

**Introduced in R2010a**

## gravitysphericalharmonic

Implement spherical harmonic representation of planetary gravity

### Syntax

```
[gx gy gz] = gravitysphericalharmonic(planet_coordinates)  
[gx gy gz] = gravitysphericalharmonic(planet_coordinates, model)  
[gx gy gz] = gravitysphericalharmonic(planet_coordinates, degree)  
[gx gy gz] = gravitysphericalharmonic(planet_coordinates, model,  
degree)  
[gx gy gz] = gravitysphericalharmonic(planet_coordinates, model,  
degree, action)  
[gx gy gz] = gravitysphericalharmonic(planet_coordinates, 'Custom',  
degree, {datafile dfreader}, action)
```

### Description

[*gx gy gz*] = gravitysphericalharmonic(*planet\_coordinates*) implements the mathematical representation of spherical harmonic planetary gravity based on planetary gravitational potential. This function calculates arrays of *N* gravity values in the *x*-axis, *y*-axis, and *z*-axis of the Planet-Centered Planet-Fixed coordinates for the planet. It performs these calculations using *planet\_coordinates*, an *M*-by-3 array of Planet-Centered Planet-Fixed coordinates. By default, this function assumes 120th degree and order spherical coefficients for the 'EGM2008' (Earth) planetary model.

[*gx gy gz*] = gravitysphericalharmonic(*planet\_coordinates*, *model*) implements the mathematical representation for the planetary model, *model*.

[*gx gy gz*] = gravitysphericalharmonic(*planet\_coordinates*, *degree*) uses the degree and order that *degree* specifies.

[*gx gy gz*] = gravitysphericalharmonic(*planet\_coordinates*, *model*, *degree*) uses the degree and order that *degree* specifies. *model* specifies the planetary model.

[*gx gy gz*] = gravitysphericalharmonic(*planet\_coordinates*, *model*, *degree*, *action*) uses the specified *action* when input is out of range.



`[gx gy gz] = gravitysphericalharmonic(planet_coordinates, 'Custom', degree, {datafile dfreader}, action)` implements the mathematical representation for a custom model planet. *datafile* defines the planetary model. *dfreader* specifies the reader for *datafile*.

This function has the following limitations:

- The function excludes the centrifugal effects of planetary rotation, and the effects of a precessing reference frame.
- Spherical harmonic gravity model is valid for radial positions greater than the planet equatorial radius. Minor errors might occur for radial positions near or at the planetary surface. The spherical harmonic gravity model is not valid for radial positions less than planetary surface.

## Input Arguments

### **planet\_coordinates**

*M*-by-3 array of Planet-Centered Planet-Fixed coordinates in meters. The *z*-axis is positive toward the North Pole. If *model* is 'EGM2008' or 'EGM96' (Earth), the planet coordinates are ECEF coordinates.

### **model**

Planetary model. Default is 'EGM2008'. Specify one:

Planetary Model	Planet
'EGM2008'	Earth Gravitational Model 2008. Planet coordinates are ECEF (WGS84).
'EGM96'	Earth Gravitational Model 1996. Planet coordinates are ECEF (WGS84).
'LP100K'	100th degree Moon model.
'LP165P'	165th degree Moon model.
'GMM2B'	Goddard Mars model 2B.
'Custom'	Custom planetary model that you define in <i>datafile</i> .

Planetary Model	Planet
	<p><b>Note:</b> To deploy a custom planetary model, explicitly include the custom data and reader files to the MATLAB Compiler (mcc) command at compilation. For example:</p> <pre>mcc -m mycustomsphericalgravityfunction... -a customDataFile -a customReaderFile</pre> <p>For other planetary models, use the MATLAB Compiler as usual.</p>
'EIGENGL04C'	Combined Earth gravity field model EIGEN-GL04C.

When inputting a large PCPF array and a high degree value, you might receive an out-of-memory error. For more information about avoiding out-of-memory errors in the MATLAB environment, see “Resolve “Out of Memory” Errors” (MATLAB).

When inputting a large PCPF array, you might receive a maximum matrix size limitation. To determine the largest matrix or array that you can create in the MATLAB environment for your platform, see “Performance and Memory” (MATLAB).

**degree**

Scalar value that specifies the degree and order of the harmonic gravity model.

Planetary Model	Degree and Order
'EGM2008'	<p>Maximum degree and order is 2159.</p> <p>Default degree and order are 120.</p>
'EGM96'	<p>Maximum degree and order is 360.</p> <p>Default degree and order are 70.</p>
'LP100K'	<p>Maximum degree and order is 100.</p> <p>Default degree and order are 60.</p>
'LP165P'	<p>Maximum degree and order is 165.</p> <p>Default degree and order are 60.</p>
'GMM2B'	<p>Maximum degree and order is 80.</p> <p>Default degree and order are 60.</p>

Planetary Model	Degree and Order
'Custom'	Maximum degree is default degree and order.
'EIGENGL04C'	Maximum degree and order is 360.  Default degree and order are 70.

When inputting a large PCPF array and a high degree value, you might receive an out-of-memory error. For more information about avoiding out-of-memory errors in the MATLAB environment, see “Performance and Memory” (MATLAB).

When inputting a large PCPF array, you might receive a maximum matrix size limitation. To determine the largest matrix or array that you can create in the MATLAB environment for your platform, see “Performance and Memory” (MATLAB).

### action

Action for out-of-range input. Specify one:

'Error'

'Warning' (default)

'None'

### 'Custom'

Character vector that specifies that *datafile* contains definitions for a custom planetary model.

### datafile

File that contains definitions for a custom planetary model. For an example of file content, see *aerogmm2b.mat*.

This file must contain the following variables.

Variable	Description
<i>Re</i>	Scalar of planet equatorial radius in meters (m)
<i>GM</i>	Scalar of planetary gravitational parameter in meters cubed per second squared ( $\text{m}^3/\text{s}^2$ )
<i>degree</i>	Scalar of maximum degree
<i>C</i>	$(\text{degree}+1)$ -by- $(\text{degree}+1)$ matrix containing normalized spherical harmonic coefficients matrix, <i>C</i>

Variable	Description
<i>S</i>	<i>(degree+1)</i> -by- <i>(degree+1)</i> matrix containing normalized spherical harmonic coefficients matrix, <i>S</i>

This parameter requires that you specify a program in the *dfreader* parameter to read the data file.

**dfreader**

Specify a MATLAB function to read *datafile*. The reader file that you specify depends on the file type of *datafile*.

Data File Type	Description
MATLAB file	Specify the MATLAB load function, for example, @load.
Other file type	Specify a custom MATLAB reader function. For examples of custom reader functions, see <i>astReadSHAFfile.m</i> and <i>astReadEGMFile.m</i> . Note the output variable order in these files.

## Output Arguments

**gx**

Array of *N* gravity values in the *x*-axis of the Planet-Centered Planet-Fixed coordinates in meters per second squared (m/s<sup>2</sup>).

**gy**

Array of *N* gravity values in the *y*-axis of the Planet-Centered Planet-Fixed coordinates in meters per second squared (m/s<sup>2</sup>).

**gz**

Array of *N* gravity values in the *z*-axis of the Planet-Centered Planet-Fixed coordinates in meters per second squared (m/s<sup>2</sup>).

## Examples

Calculate the gravity in the *x*-axis at the equator on the surface of Earth. This example uses the default 120 degree model of EGM2008 with default warning actions:

```
gx = gravitysphericalharmonic( [-6378.1363e3 0 0] )
```

Calculate the gravity at 25000 m over the south pole of Earth. This example uses the 70 degree model of EGM96 with error actions:

```
[gx, gy, gz] = gravitysphericalharmonic( [0 0 -6381.751e3], 'EGM96', 'Error' )
```

Calculate the gravity at 15000 m over the equator and 11000 m over the North Pole. This example uses a 30th order GMM2B Mars model with warning actions:

```
p = [2412.648e3 -2412.648e3 0; 0 0 3376.2e3]
[gx, gy, gz] = gravitysphericalharmonic( p, 'GMM2B', 30, 'Warning' )
```

Calculate the gravity at 15000 m over the equator and 11000 m over the North Pole. This example uses a 60th degree custom planetary model with no actions:

```
p = [2412.648e3 -2412.648e3 0; 0 0 3376e3]
[gx, gy, gz] = gravitysphericalharmonic( p, 'custom', 60, ...
{'GMM2BC80_SHA.txt' @astReadSHAFile}, 'None' )
```

Calculate the gravity at 25000 meters over the south pole of Earth using a 120th order EIGEN-GL04C Earth model with warning actions:

```
p = [0 0 -6381.751e3]
[gx, gy, gz] = gravitysphericalharmonic( p, 'EIGENGL04C', ...
120, 'Warning' )
```

## Tips

- When inputting a large PCPF array and a high degree value, you might receive an out-of-memory error. For more information about avoiding out-of-memory errors in the MATLAB environment, see “Performance and Memory” (MATLAB).
- When inputting a large PCPF array, you might receive a maximum matrix size limitation. To determine the largest matrix or array that you can create in the MATLAB environment for your platform, see “Performance and Memory” (MATLAB).

## References

- [1] Gottlieb, R. G., “Fast Gravity, Gravity Partial, Normalized Gravity, Gravity Gradient Torque and Magnetic Field: Derivation, Code and Data,” *Technical Report NASA Contractor Report 188243*, NASA Lyndon B. Johnson Space Center, Houston, Texas, February 1993.
- [2] Vallado, D. A., *Fundamentals of Astrodynamics and Applications*, McGraw-Hill, New York, 1997.

- [3] “NIMA TR8350.2: Department of Defense World Geodetic System 1984, Its Definition and Relationship with Local Geodetic Systems”.
- [4] Konopliv, A. S., S. W. Asmar, E. Carranza, W. L. Sjogren, D. N. Yuan., “Recent Gravity Models as a Result of the Lunar Prospector Mission, Icarus”, Vol. 150, no. 1, pp 1–18, 2001.
- [5] Lemoine, F. G., D. E. Smith, D.D. Rowlands, M.T. Zuber, G. A. Neumann, and D. S. Chinn, “An improved solution of the gravity field of Mars (GMM-2B) from Mars Global Surveyor”, *Journal Of Geophysical Research*, Vol. 106, No. E10, pp 23359-23376, October 25, 2001.
- [6] Kenyon S., J. Factor, N. Pavlis, and S. Holmes, “Towards the Next Earth Gravitational Model”, Society of Exploration Geophysicists 77th Annual Meeting, San Antonio, Texas, September 23–28, 2007.
- [7] Pavlis, N.K., S.A. Holmes, S.C. Kenyon, and J.K. Factor, “An Earth Gravitational Model to Degree 2160: EGM2008”, presented at the 2008 General Assembly of the European Geosciences Union, Vienna, Austria, April 13–18, 2008.
- [8] Grueber, T., and A. Köhl, “Validation of the EGM2008 Gravity Field with GPS-Leveling and Oceanographic Analyses”, presented at the IAG International Symposium on Gravity, Geoid & Earth Observation 2008, Chania, Greece, June 23–27, 2008.
- [9] Förste, C., Flechtner, F., Schmidt, R., König, R., Meyer, U., Stubenvoll, R., Rothacher, M., Barthelmes, F., Neumayer, H., Biancale, R., Bruinsma, S., Lemoine, J.M., Loyer, S., “A Mean Global Gravity Field Model From the Combination of Satellite Mission and Altimetry/Gravmetry Surface Data - EIGEN-GL04C”, *Geophysical Research Abstracts*, Vol. 8, 03462, 2006.
- [10] Hill, K. A. (2007). Autonomous Navigation in Libration Point Orbits. Doctoral dissertation, University of Colorado, Boulder. [http://ccar.colorado.edu/geryon/papers/Misc/Hill\\_thesis.pdf](http://ccar.colorado.edu/geryon/papers/Misc/Hill_thesis.pdf).
- [11] Colombo, Oscar L., “Numerical Methods for Harmonic Analysis on the Sphere”, Reports of the department of Geodetic Science, Report No. 310, The Ohio State University, Columbus, OH., March 1981.
- [12] Colombo, Oscar L., “The Global Mapping of Gravity with Two Satellites”, Netherlands Geodetic Commission, vol. 7 No. 3, Delft, The Netherlands, 1984., Reports of the

department of Geodetic Science, Report No. 310, The Ohio State University, Columbus, OH., March 1981.

- [13] Jones, Brandon A. (2010). Efficient Models for the Evaluation and Estimation of the Gravity Field. Doctoral dissertation, University of Colorado, Boulder. [http://ccar.colorado.edu/geryon/papers/Misc/bajones\\_phd.pdf](http://ccar.colorado.edu/geryon/papers/Misc/bajones_phd.pdf).

## **See Also**

gravitywgs84 | gravitycentrifugal | gravityzonal | geoidegm96

**Introduced in R2010a**

## gravitywgs84

Implement 1984 World Geodetic System (WGS84) representation of Earth's gravity

### Syntax

```
g = gravitywgs84(h, lat)
g = gravitywgs84(h, lat, lon, method, [noatm, nocent, prec, jd],
action)
gn = gravitywgs84(h, lat, lon, 'Exact', [noatm, nocent, prec, jd],
action)
[gn gt] = gravitywgs84(h, lat, lon, 'Exact', [noatm, nocent, prec,
jd], action)
```

### Description

`g = gravitywgs84(h, lat)` implements the mathematical representation of the geocentric equipotential ellipsoid of WGS84. Using `h`, an array of `m` altitudes in meters, and `lat`, an array of `m` geodetic latitudes in degrees, calculates `g`, an array of `m` gravity values in the direction normal to the Earth's surface at a specific location. The default calculation method is Taylor Series. Gravity precision is controlled via the `method` parameter.

`g = gravitywgs84(h, lat, lon, method, [noatm, nocent, prec, jd], action)` lets you specify both latitude and longitude, as well as other optional inputs, when calculating gravity values in the direction normal to the Earth's surface. In this format, `method` can be either `'CloseApprox'` or `'Exact'`.

`gn = gravitywgs84(h, lat, lon, 'Exact', [noatm, nocent, prec, jd], action)` calculates an array of total gravity values in the direction normal to the Earth's surface.

`[gn gt] = gravitywgs84(h, lat, lon, 'Exact', [noatm, nocent, prec, jd], action)` calculates gravity values in the direction both normal and tangential to the Earth's surface.

Inputs for `gravitywgs84` are:

`h`                                      An array of `m` altitudes, in meters



---

lat	An array of $m$ geodetic latitudes, in degrees, where north latitude is positive, and south latitude is negative
lon	An array of $m$ geodetic longitudes, in degrees, where east longitude is positive, and west longitude is negative. This input is available only with <code>method</code> specified as 'CloseApprox' or 'Exact'.
method	Method to calculate gravity: 'TaylorSeries', 'CloseApprox', or 'Exact'. The default is 'TaylorSeries'.
noatm	A logical value specifying the exclusion of Earth's atmosphere. Set to <code>true</code> for the Earth's gravitational field to exclude the mass of the atmosphere. Set to <code>false</code> for the value for the Earth's gravitational field to include the mass of the atmosphere. This option is available only with <code>method</code> specified as 'CloseApprox' or 'Exact'. The default is <code>false</code> .
nocent	A logical value specifying the removal of centrifugal effects. Set to <code>true</code> to calculate gravity based on pure attraction resulting from the normal gravitational potential. Set to <code>false</code> to calculate gravity including the centrifugal force resulting from the Earth's angular velocity. This option is available only with <code>method</code> specified as 'CloseApprox' or 'Exact'. The default is <code>false</code> .
prec	A logical value specifying the presence of a precessing reference frame. Set to <code>true</code> for the angular velocity of the Earth to be calculated using the International Astronomical Union (IAU) value of the Earth's angular velocity and the precession rate in right ascension. To obtain the precession rate in right ascension, Julian Centuries from Epoch J2000.0 is calculated using the Julian date, <code>jd</code> . If set to <code>false</code> , the angular velocity of the Earth used is the value of the standard Earth rotating at a constant angular velocity. This option is available only with <code>method</code> specified as 'CloseApprox' or 'Exact'. The default is <code>false</code> .
jd	A scalar value specifying Julian date used to calculate Julian Centuries from Epoch J2000.0. This input is available only with <code>method</code> specified as 'CloseApprox' or 'Exact'.

**action** Action for out-of-range input. Specify if out-of-range input invokes a 'Warning', 'Error', or no action ('None'). The default is 'Warning'.

Outputs calculated for the Earth's gravity include:

**g** An array of  $m$  gravity values in the direction normal to the Earth's surface at a specific `lat lon` location. A positive value indicates a downward direction.

**gt** An array of  $m$  gravity values in the direction tangential to the Earth's surface at a specific `lat lon` location. A positive value indicates a northward direction. This option is available only with `method` specified as 'Exact'.

**gn** An array of  $m$  total gravity values in the direction normal to the Earth's surface at a specific `lat lon` location. A positive value indicates a downward direction. This option is available only with `method` specified as 'Exact'.

## Examples

Calculate the normal gravity at 5000 meters and 55 degrees latitude using the Taylor Series approximation method with errors for out-of-range inputs:

```
g = gravitywgs84( 5000, 55, 'TaylorSeries', 'Error' )
```

```
g =
```

```
9.7997
```

Calculate the normal gravity at 15,000 meters, 45 degrees latitude, and 120 degrees longitude using the Close Approximation method with atmosphere, centrifugal effects, and no precessing, with warnings for out-of-range inputs:

```
g = gravitywgs84( 15000, 45, 120, 'CloseApprox' )
```

```
g =
```

```
9.7601
```

Calculate the normal and tangential gravity at 1000 meters, 0 degrees latitude, and 20 degrees longitude using the Exact method with atmosphere, centrifugal effects, and no precessing, with warnings for out-of-range inputs:

```
[gn, gt] = gravitywgs84( 1000, 0, 20, 'Exact' )
```

```
gn =
```

```
    9.7772
```

```
gt =
```

```
    0
```

Calculate the normal and tangential gravity at 1000 meters, 0 degrees latitude, and 20 degrees longitude and 11,000 meters, 30 degrees latitude, and 50 degrees longitude using the Exact method with atmosphere, centrifugal effects, and no precessing, with no actions for out-of-range inputs:

```
h = [1000; 11000];
```

```
lat = [0; 30];
```

```
lon = [20; 50];
```

```
[gn, gt] = gravitywgs84( h, lat, lon, 'Exact', 'None' )
```

```
gn =
```

```
    9.7772
```

```
    9.7594
```

```
gt =
```

```
    1.0e-04 *
```

```
    0
```

```
   -0.7751
```

Calculate the normal gravity at 15,000 meters, 45 degrees latitude, and 120 degrees longitude and 5000 meters, 55 degrees latitude, and 100 degrees longitude using the Close Approximation method with atmosphere, no centrifugal effects, and no precessing, with warnings for out-of-range inputs:

```
h = [15000 5000];
```

```
lat = [45 55];
```

```
lon = [120 100];
```

```
g = gravitywgs84( h, lat, lon, 'CloseApprox', [false true false 0] )
```

```
g =  
    9.7771    9.8109
```

Calculate the normal and tangential gravity at 1000 meters, 0 degrees latitude, and 20 degrees longitude using the Exact method with atmosphere, centrifugal effects, and precessing at Julian date 2451545, with warnings for out-of-range inputs:

```
[gn, gt] = gravitywgs84( 1000, 0, 20, 'Exact', ...  
                        [ false false true 2451545 ], 'Warning')
```

```
gn =  
    9.7772
```

```
gt =  
    0
```

Calculate the normal gravity at 15,000 meters, 45 degrees latitude, and 120 degrees longitude using the Close Approximation method with no atmosphere, with centrifugal effects, and with precessing at Julian date 2451545, with errors for out-of-range inputs:

```
g = gravitywgs84( 15000, 45, 120, 'CloseApprox', ...  
                [ true false true 2451545 ], 'Error')
```

```
g =  
    9.7601
```

Calculate the total normal gravity at 15,000 meters, 45 degrees latitude, and 120 degrees longitude using the Exact method with no atmosphere, with centrifugal effects, and with precessing at Julian date 2451545, with errors for out-of-range inputs:

```
gn = gravitywgs84( 15000, 45, 120, 'Exact', ...  
                [ true false true 2451545 ], 'Error')
```

```
gn =  
    9.7601
```

## Assumptions and Limitations

The WGS84 gravity calculations are based on the assumption of a geocentric equipotential ellipsoid of revolution. Since the gravity potential is assumed to be the same everywhere on the ellipsoid, there must be a specific theoretical gravity potential that can be uniquely determined from the four independent constants defining the ellipsoid.

Use of the WGS84 Taylor Series model should be limited to low geodetic heights. It is sufficient near the surface when submicrogal precision is not necessary. At medium and high geodetic heights, it is less accurate.

Use of the WGS84 Close Approximation model should be limited to a geodetic height of 20,000.0 meters (approximately 65,620.0 feet). Below this height, it gives results with submicrogal precision.

To predict and determine a satellite orbit with high accuracy, use the EGM96 through degree and order 70.

## References

NIMA TR8350.2: "Department of Defense World Geodetic System 1984, Its Definition and Relationship with Local Geodetic Systems."

**Introduced in R2006b**

## gravityzonal

Implement zonal harmonic representation of planetary gravity

### Syntax

```
[gravityXcoord gravityYcoord, gravityZcoord] =  
gravityzonal(planetCoord)  
[gravityXcoord gravityYcoord, gravityZcoord] =  
gravityzonal(planetCoord, degreeGravityModel)  
[gravityXcoord gravityYcoord, gravityZcoord] =  
gravityzonal(planetCoord, planetModel)  
[gravityXcoord gravityYcoord, gravityZcoord] =  
gravityzonal(planetCoord, planetModel, degreeGravityModel)  
[gravityXcoord gravityYcoord, gravityZcoord] =  
gravityzonal(planetCoord, planetModel, degreeGravityModel, action)  
[gravityXcoord gravityYcoord, gravityZcoord] =  
gravityzonal(planetCoord, 'Custom', equatorialRadius,  
planetaryGravitational, zonalHarmonicCoeff, action)
```

### Description

[gravityXcoord gravityYcoord, gravityZcoord] = gravityzonal(planetCoord) implements the mathematical representation of zonal harmonic planetary gravity based on planetary gravitational potential. For input, it takes an m-by-3 matrix that contains planet-centered planet-fixed coordinates from the center of the planet in meters. This function calculates the arrays of m gravity values in the x-, y-, and z-axes of the planet-centered planet-fixed coordinates. It uses the fourth order zonal coefficients for Earth by default.

[gravityXcoord gravityYcoord, gravityZcoord] = gravityzonal(planetCoord, degreeGravityModel) uses the degree of harmonic model.

[gravityXcoord gravityYcoord, gravityZcoord] = gravityzonal(planetCoord, planetModel) uses the planetary model.

`[gravityXcoord gravityYcoord, gravityZcoord] = gravityzonal(planetCoord, planetModel, degreeGravityModel)` uses the degree of harmonic model and planetary model.

`[gravityXcoord gravityYcoord, gravityZcoord] = gravityzonal(planetCoord, planetModel, degreeGravityModel, action)` specifies the action for out-of-range input.

`[gravityXcoord gravityYcoord, gravityZcoord] = gravityzonal(planetCoord, 'Custom', equatorialRadius, planetaryGravitational, zonalHarmonicCoeff, action)` uses the equatorial radius, planetary gravitational parameter, and zonal harmonic coefficients for the custom planetary model.

This function does not include the potential due planet rotation, which excludes the centrifugal effects of planetary rotation and the effects of a precessing reference frame.

## Input Arguments

### **planetCoord**

m-by-3 matrix that contains planet-centered planet-fixed coordinates from the center of the planet in meters. If `planetModel` has a value of 'Earth', this matrix contains Earth-centered Earth-fixed (ECEF) coordinates.

### **planetModel**

Planetary model. Enter one:

- 'Mercury'
- 'Venus'
- 'Earth'
- 'Moon'
- 'Mars'
- 'Jupiter'
- 'Saturn'
- 'Uranus'
- 'Neptune'

- 'Custom'

'Custom' requires you to specify your own planetary model using the `equatorialRadius`, `planetaryGravitational`, and `zonalHarmonicCoeff` parameters.

**Default:** 'Earth'

### **degreeGravityModel**

Degree of harmonic model.

- 2 — Second degree, J2. Most significant or largest spherical harmonic term, which accounts for the oblateness of a planet. 2 is default if `planetModel` is 'Mercury', 'Venus', 'Moon', 'Uranus', or 'Neptune'.
- 3 — Third degree, J3. 3 is default if `planetModel` is 'Mars'.
- 4 — Fourth degree, J4 (default). Default is 4 if `planetModel` is 'Earth', 'Jupiter', 'Saturn' or 'Custom'.

**Default:**

### **equatorialRadius**

Planetary equatorial radius in meters. Use this parameter only if you specify `planetModel` as 'Custom'.

### **planetaryGravitational**

Planetary gravitational parameter in meters cubed per second squared. Use this parameter only if you specify `planetModel` as 'Custom'.

### **zonalHarmonicCoeff**

3-element array defining the zonal harmonic coefficients that the function uses to calculate zonal harmonics planetary gravity. Use this parameter only if you specify `planetModel` as 'Custom'.

### **action**

Action for out-of-range input. Specify one:

- 'Error'
- 'Warning'



'None' (default)

## Output Arguments

### **gravityXcoord**

Array of  $m$  gravity values in the  $x$ -axis of the planet-centered planet-fixed coordinates in meters per second squared.

**Default:**

### **gravityYcoord**

Array of  $m$  gravity values in the  $y$ -axis of the planet-centered planet-fixed coordinates in meters per second squared.

**Default:**

### **gravityZcoord**

Array of  $m$  gravity values in the  $z$ -axis of the planet-centered planet-fixed coordinates in meters per second squared.

**Default:**

## Examples

Calculate the gravity in the  $x$ -axis at the equator on the surface of Earth using the fourth degree model with no warning actions:

```
gx = gravityzonal( [-6378.1363e3 0 0] )
```

```
gx =
```

```
9.8142
```

Calculate the gravity using the close approximation method at 100 m over the geographic South Pole of Earth with error actions:

```
[gx, gy, gz] = gravityzonal( [0 0 -6356.851e3], 'Error' )
```

```
gx =
    0
```

```
gy =
    0
```

```
gz =
    9.8317
```

Calculate the gravity at 15000 m over the equator and 11000 m over the geographic North Pole using a second order Mars model with warning actions:

```
p = [2412.648e3 -2412.648e3 0; 0 0 3376.2e3]
[ gx, gy, gz ] = gravityzonal( p, 'Mars', 2, 'Warning' )
p =
    2412648    -2412648         0
         0         0    3376200
```

```
gx =
   -2.6224
         0
```

```
gy =
    2.6224
         0
```

```
gz =
         0
   -3.7542
```

Calculate the gravity at 15000 m over the equator and 11000 m over the geographic North Pole using a custom planetary model with no actions:

```
p= [2412.648e3 -2412.648e3 0; 0 0 3376e3]
GM   = 42828.371901e9 % m^3/s^2
Re   = 3397e3 % m
Jvalues = [1.95545367944545e-3 3.14498094262035e-5 ...
```

```
-1.53773961526397e-5]
[gx, gy, gz] = gravityzonal( p, 'custom', Re, GM, ...
Jvalues, 'None' )
```

## Algorithms

gravityzonal is implemented using the following planetary parameter values for each planet:

Planet	Equatorial Radius (Re) in Meters	Gravitational Parameter (GM) in m <sup>3</sup> /s <sup>2</sup>	Zonal Harmonic Coefficients (J Values)
Earth	6378.1363e3	3.986004415e14	[ 0.0010826269 -0.0000025323 -0.0000016204 ]
Jupiter	71492.e3	1.268e17	[0.01475 0 -0.00058]
Mars	3397.2e3	4.305e13	[ 0.001964 0.000036 ]
Mercury	2439.0e3	2.2032e13	0.00006
Moon	1738.0e3	4902.799e9	0.0002027
Neptune	24764e3	6.809e15	0.004
Saturn	60268.e3	3.794e16	[0.01645 0 -0.001]
Uranus	25559.e3	5.794e15	0.012
Venus	6052.0e3	3.257e14	0.000027

## Alternatives

Zonal Harmonic Gravity Model block

## References

Vallado, D. A., *Fundamentals of Astrodynamics and Applications*, McGraw-Hill, New York, 1997.

Fortescue, P., J. Stark, G. Swinerd, (Eds.). *Spacecraft Systems Engineering*, Third Edition, Wiley & Sons, West Sussex, 2003.

Tewari, A., *Atmospheric and Space Flight Dynamics Modeling and Simulation with MATLAB and Simulink*, Birkhäuser, Boston, 2007.

## **See Also**

gravitywgs84 | geoidegm96

**Introduced in R2009b**

# hide

**Class:** Aero.Animation

**Package:** Aero

Hide animation figure

## Syntax

```
hide(h)  
h.hide
```

## Description

`hide(h)` and `h.hide` hide (close) the figure for the animation object `h`. Use `Aero.Animation.show` to redisplay the animation object figure.

## Input Arguments

`h`                      Animation object.

## Examples

Hide the animation object figure that the `Aero.Animation.show` method displays.

```
h=Aero.Animation;  
h.show;  
h.hide;
```

## igrfmagm

Calculate Earth magnetic field and secular variation using International Geomagnetic Reference Field

### Syntax

```
[magFieldVector,horIntensity,declination,inclination,totalIntensity,  
magFieldSecVariation,secVariationHorizontal,secVariationDeclination,  
secVariationInclination,secVariationTotal] = igrfmagm(height,  
latitude,longitude,decimalYear,generation)
```

### Description

[magFieldVector,horIntensity,declination,inclination,totalIntensity, magFieldSecVariation,secVariationHorizontal,secVariationDeclination, secVariationInclination,secVariationTotal] = igrfmagm(height, latitude,longitude,decimalYear,generation) calculates the Earth magnetic field and the secular variation at a specific location and time using different generations of the International Geomagnetic Reference Field.

### Examples

#### Calculate the Magnetic Model

Calculate the magnetic model 1000 meters over Natick, Massachusetts on July 4, 2015 using IGRF-12.

```
[mag_field_vector,hor_intensity,declination,inclination,total_intensity] ...  
= igrfmagm(1000,42.283,-71.35,decyear(2015,7,4),12)
```

```
mag_field_vector =
```

```
1.0e+04 *  
1.9460 -0.5091 4.8179
```

```
hor_intensity =
```

```
2.0115e+04
declination =
-14.6612
inclination =
67.3387
total_intensity =
5.2209e+04
```

## Input Arguments

### **height** — Distance

scalar

Distance, in meters, from the surface of the Earth, specified as a scalar.

### **latitude** — Geodetic latitude

scalar

Geodetic latitude, in degrees, specified as a scalar. North latitude is positive, and south latitude is negative.

### **longitude** — Geodetic longitude

scalar

Geodetic longitude, in degrees, specified as a scalar. East longitude is positive, and west longitude is negative.

### **decimalYear** — Year

scalar

Year, in decimal format, specified as a decimal. This value is the desired year, including any fraction of the year that has already passed.

### **generation** — Generation version of International Geomagnetic Reference Field

12 (default) | 11

Generation version of the International Geomagnetic Reference Field, specified as 11 or 12.

## Output Arguments

### **magFieldVector** — Magnetic field vector

vector

Magnetic field vector, in nanotesla (nT), returned as a vector. *Z* is the vertical component (+ve down).

### **horIntensity** — Horizontal intensity

scalar

Horizontal intensity, in nanotesla (nT), returned as a scalar.

### **declination** — Declination

scalar

Declination, in degrees (+ve east), returned as a scalar.

### **inclination** — Inclination

scalar

Inclination, in degrees (+ve down), returned as a scalar.

### **totalIntensity** — Total intensity

scalar

Total intensity, in nanotesla (nT), returned as a scalar.

### **magFieldSecVariation** — Secular variation in magnetic field vector

vector

Secular variation in magnetic field vector, in nT/year, returned as a vector. *Z* is the vertical component (+ve down).

### **secVariationHorizontal** — Secular variation in horizontal intensity

scalar

Secular variation in horizontal intensity, in nT/year, returned as a scalar.



**secVariationDeclination** — Secular variation in declination

scalar

Secular variation in declination, in minutes/year (+ve east), returned as a scalar.

**secVariationInclination** — Secular variation in inclination

scalar

Secular variation in inclination, in minutes/year (+ve down), returned as a scalar.

**secVariationTotal** — Secular variation in total intensity

scalar

Secular variation in total intensity, in nT/year, returned as a scalar.

## Limitation

This function is valid between the heights of –1000 meters to 600,000 meters.

The 11th generation is valid between the years of 1900 and 2015, and 12th generation is valid between the years of 1900 and 2020.

This function has the limitations of the International Geomagnetic Reference Field (IGRF). For more information, see the IGRF website, <http://www.ngdc.noaa.gov/IAGA/vmod/igrfhw.html>.

## References

- [1] Blakely, R. J. *Potential Theory in Gravity & Magnetic Applications*. Cambridge, UK: Cambridge University Press, 1996.
- [2] Lowes, F. J. “The International Geomagnetic Reference Field: A 'Health' Warning.” January, 2010. <http://www.ngdc.noaa.gov/IAGA/vmod/igrfhw.html>.

## See Also

### See Also

decyear | wrldmagm

**External Websites**

<http://www.ngdc.noaa.gov/LAGA/vmod/igrfhw.html>

**Introduced in R2015b**

# initialize

**Class:** Aero.Animation

**Package:** Aero

Create animation object figure and axes and build patches for bodies

## Syntax

```
initialize(h)  
h.initialize
```

## Description

`initialize(h)` and `h.initialize` create a figure and axes for the animation object `h`, and builds patches for the bodies associated with the animation object. If there is an existing figure, this function

- 1 Clears out the old figure and its patches.
- 2 Creates a new figure and axes with default values.
- 3 Repopulates the axes with new patches using the surface to patch data from each body.

## Input Arguments

`h` Animation object.

## Examples

Initialize the animation object, `h`.

```
h = Aero.Animation;  
h.initialize();
```

## initialize (Aero.FlightGearAnimation)

Set up FlightGear animation object

### Syntax

```
initialize(h)  
h.initialize
```

### Description

`initialize(h)` and `h.initialize` set up the FlightGear version, IP address, and socket for the FlightGear animation object `h`.

### Examples

Initialize the animation object, `h`.

```
h = Aero.FlightGearAnimation;  
h.initialize();
```

### See Also

`play` | `delete` | `GenerateRunScript` | `update`

**Introduced in R2007a**

# initialize (Aero.VirtualRealityAnimation)

Create and populate virtual reality animation object

## Syntax

```
initialize(h)  
h.initialize
```

## Description

`initialize(h)` and `h.initialize` create a virtual reality animation world and populate the virtual reality animation object `h`. If a previously initialized virtual reality animation object exists, and that object has user-specified data, this function saves the previous object to be reset after the initialization.

## Examples

Initialize the virtual reality animation object, `h`.

```
h = Aero.VirtualRealityAnimation;  
h.VRWorldFilename = [matlabroot, '/toolbox/aero/astdemos/asttkoff.wrl'];  
copyfile(h.VRWorldFilename, [tempdir, 'asttkoff.wrl'], 'f');  
h.VRWorldFilename = [tempdir, 'asttkoff.wrl'];  
h.initialize();
```

## See Also

`delete` | `play`

Introduced in R2007b

## initIfNeeded

**Class:** Aero.Animation

**Package:** Aero

Initialize animation graphics if needed

### Syntax

```
initIfNeeded(h)  
h.initIfNeeded
```

### Description

`initIfNeeded(h)` and `h.initIfNeeded` initialize animation object graphics if necessary.

### Input Arguments

`h`                      Animation object.

### Examples

Initialize the animation object graphics of `h` as needed.

```
h=Aero.Animation;  
h.initIfNeeded;
```

# juliandate

Julian date calculator

## Syntax

```
jd = juliandate(v)
jd = juliandate(s,f)
jd = juliandate(y,mo,d)
jd = juliandate([y,mo,d])
jd = juliandate(y,mo,d,h,mi,s)
jd = juliandate([y,mo,d,h,mi,s])
```

## Description

`jd = juliandate(v)` converts one or more date vectors, `v`, into Julian date, `jd`. Input `v` can be an `m`-by-6 or `m`-by-3 matrix containing `m` full or partial date vectors, respectively. `juliandate` returns a column vector of `m` Julian dates, which are the number of days and fractions since noon Universal Time on January 1, 4713 BCE.

A date vector contains six elements, specifying year, month, day, hour, minute, and second. A partial date vector has three elements, specifying year, month, and day. Each element of `v` must be a positive double-precision number.

`jd = juliandate(s,f)` converts one or more dates, `s`, into Julian date, `jd`, using format `f`. `s` can be a character array, where each row corresponds to one date character vector, or a one-dimensional cell array of character vectors. `juliandate` returns a column vector of `m` Julian dates, where `m` is the number of character vectors in `s`.

All of the dates in `s` must have the same format `f`, composed of the same date format symbols as `datestr`. `juliandate` does not accept formats containing the letter `Q`.

If the format does not contain enough information to compute a date number, then:

- Hours, minutes, and seconds default to 0.
- Days default to 1.
- Months default to January.
- Years default to the current year.

Dates with two-character years are interpreted to be within 100 years of the current year.

`jd = juliandate(y,mo,d)` and `jd = juliandate([y,mo,d])` return the decimal year for corresponding elements of the `y,mo,d` (year,month,day) arrays. Specify `y, mo,` and `d` as one-dimensional arrays of the same length or scalar values.

`jd = juliandate(y,mo,d,h,mi,s)` and `jd = juliandate([y,mo,d,h,mi,s])` return the Julian dates for corresponding elements of the `y,mo,d,h,mi,s` (year,month,day,hour,minute,second) arrays. Specify the six input arguments as either one-dimensional arrays of the same length or scalar values.

### Examples

Calculate Julian date for May 24, 2005:

```
jd = juliandate('24-May-2005', 'dd-mmm-yyyy')
```

```
jd =
```

```
2.4535e+006
```

Calculate Julian date for December 19, 2006:

```
jd = juliandate(2006,12,19)
```

```
jd =
```

```
2.4541e+006
```

Calculate Julian date for October 10, 2004, at 12:21:00 p.m.:

```
jd = juliandate(2004,10,10,12,21,0)
```

```
jd =
```

```
2.4533e+006
```

### Assumptions and Limitations

This function is valid for all common era (CE) dates in the Gregorian calendar.



The calculation of Julian date does not take into account leap seconds.

## **See Also**

`decyear` | `leapyear` | `mjuliandate`

**Introduced in R2006b**

# leapyear

Determine leap year

## Syntax

```
ly = leapyear(year)
```

## Description

`ly = leapyear(year)` determines whether one or more years are leap years or not. The output, `ly`, is a logical array. `year` should be numeric.

## Examples

Determine whether 2005 is a leap year:

```
ly = leapyear(2005)
```

```
ly =
```

```
0
```

Determine whether 2000, 2005, and 2020 are leap years:

```
ly = leapyear([2000 2005 2020])
```

```
ly =
```

```
1    0    1
```

## Assumptions and Limitations

The determination of leap years is done by Gregorian calendar rules.

## See Also

`decyear` | `juliandate` | `mjuliandate`

**Introduced in R2006b**

# lla2ecef

Convert geodetic coordinates to Earth-centered Earth-fixed (ECEF) coordinates

## Syntax

```
p = lla2ecef(lla)
p = lla2ecef(lla, model)
p = lla2ecef(lla, f, Re)
```

## Description

`p = lla2ecef(lla)` converts an  $m$ -by-3 array of geodetic coordinates (latitude, longitude and altitude), `lla`, to an  $m$ -by-3 array of ECEF coordinates, `p`. `lla` is in [degrees degrees meters]. `p` is in meters. The default ellipsoid planet is WGS84. Latitude and longitude values can be any value. However, latitude values of +90 and -90 may return unexpected values because of singularity at the poles.

`p = lla2ecef(lla, model)` is an alternate method for converting the coordinates for a specific ellipsoid planet. Currently only 'WGS84' is supported for `model`. Latitude and longitude values can be any value. However, latitude values of +90 and -90 may return unexpected values because of singularity at the poles.

`p = lla2ecef(lla, f, Re)` is another alternate method for converting the coordinates for a custom ellipsoid planet defined by flattening, `f`, and the equatorial radius, `Re`, in meters. Latitude and longitude values can be any value. However, latitude values of +90 and -90 may return unexpected values because of singularity at the poles.

## Examples

Determine ECEF coordinates at a latitude, longitude, and altitude:

```
p = lla2ecef([0 45 1000])
```

```
p =
```

```
1.0e+006 *
```

```
4.5107 4.5107 0
```

Determine ECEF coordinates at multiple latitudes, longitudes, and altitudes, specifying WGS84 ellipsoid model:

```
p = lla2ecef([0 45 1000; 45 90 2000], 'WGS84')
```

```
p =
```

```
1.0e+006 *
```

```
4.5107 4.5107 0
0.0000 4.5190 4.4888
```

Determine ECEF coordinates at multiple latitudes, longitudes, and altitudes, specifying custom ellipsoid model:

```
f = 1/196.877360;
```

```
Re = 3397000;
```

```
p = lla2ecef([0 45 1000; 45 90 2000], f, Re)
```

```
p =
```

```
1.0e+006 *
```

```
2.4027 2.4027 0
0.0000 2.4096 2.3852
```

## See Also

[ecef2lla](#) | [geoc2geod](#) | [geod2geoc](#)

**Introduced in R2006b**

## lla2eci

Convert geodetic latitude, longitude, altitude (LLA) coordinates to Earth-centered inertial (ECI) coordinates

### Syntax

```
position = lla2eci(lla,utc)
```

```
position = lla2eci(lla,utc,reduction)
```

```
position = lla2eci(lla,utc,reduction,deltaAT)
```

```
position = lla2eci(lla,utc,reduction,deltaAT,deltaUT1)
```

```
position = lla2eci(lla,utc,reduction,deltaAT,deltaUT1,polarmotion)
```

```
position = lla2eci(lla,utc,reduction,deltaAT,deltaUT1,polarmotion,  
Name,Value)
```

### Description

`position = lla2eci(lla,utc)` converts geodetic latitude, longitude, altitude (LLA) coordinates to Earth-centered inertial (ECI) position coordinates as an  $M$ -by-3 array. The conversion is based on the Universal Coordinated Time (UTC) you specify.

`position = lla2eci(lla,utc,reduction)` converts geodetic latitude, longitude, altitude (LLA) coordinates to Earth-centered inertial (ECI) position coordinates as an  $M$ -by-3 array. The conversion is based on the specified reduction method and the Universal Coordinated Time (UTC) you specify.

`position = lla2eci(lla,utc,reduction,deltaAT)` uses the difference between International Atomic Time and UTC that you specify as `deltaAT` to calculate the ECI coordinates.

`position = lla2eci(lla,utc,reduction,deltaAT,deltaUT1)` uses the difference between UTC and Universal Time (UT1), which you specify as `deltaUT1`, in the calculation.

`position = lla2eci(lla,utc,reduction,deltaAT,deltaUT1,polarmotion)` uses the polar displacement, `polarmotion`, in the calculation.

`position = lla2eci(lla,utc,reduction,deltaAT,deltaUT1,polarmotion, Name,Value)` uses additional options specified by one or more Name,Value pair arguments.

## Examples

### Convert Position to ECI Coordinates Using UTC

Convert the position to ECI coordinates from LLA coordinates 6 degrees north, 75 degrees west, and 1000 meters altitude at 01/17/2010 10:20:36 UTC.

```
position = lla2eci([6 -75 1000],[2010 1 17 10 20 36])
```

```
position=
```

```
1.0e+06 *
-6.0744 -1.8289 0.6685
```

### Convert Position to ECI coordinates Using UTC and Reduction Method IAU-76/FK5

Convert the position to ECI coordinates from LLA coordinates 55 deg south, 75 deg west, and 500 meters altitude at 01/12/2000 4:52:12.4 UTC. Specify all arguments, including optional ones such as polar motion.

```
position = lla2eci([-55 -75 500],[2000 1 12 4 52 12.4],...
'IAU-76/FK5',32,0.234,[-0.0682e-5 0.1616e-5],...
'dNutation',[-0.2530e-6 -0.0188e-6],...
'flattening',1/290,'RE',60000)
```

```
position=
```

```
1.0e+04 *
-1.1358 3.2875 -4.9333
```

## Input Arguments

**lla** — Latitude, longitude, altitude (LLA) coordinates

*M*-by-3 array

Latitude, longitude, altitude (LLA) coordinates as  $M$ -by-3 array of geodetic coordinates, in degrees, degrees, and meters, respectively. Latitude and longitude values can be any value. However, latitude values of +90 and -90 may return unexpected values because of singularity at the poles.

### **utc – Universal Coordinated Time**

1-by-6 array |  $M$ -by-6 matrix

Universal Coordinated Time (UTC), in the order year, month, day, hour, minutes, and seconds, for which the function calculates the conversion, specified as one of the following.

- For the year value, enter a double value that is a whole number greater than 1, such as 2013.
- For the month value, enter a double value that is a whole number greater than 0, within the range 1 to 12.
- For the hour value, enter a double value that is a whole number greater than 0, within the range 1 to 24.
- For the hour value, enter a double value that is a whole number greater than 0, within the range 1 to 60.
- For the minute and second values, enter a double value that is a whole number greater than 0, within the range 1 to 60.

Specify these values in one of the following formats:

- 1-by-6 array

Specify a 1-row-by-6-column array of UTC values.

- $M$ -by-6 matrix

Specify an  $M$ -by-6 array of UTC values, where  $M$  is the number of transformation matrices to calculate. Each row corresponds to one set of UTC values.

This is a one row-by-6 column array of UTC values.

Example: [2000 1 12 4 52 12.4]

This is an  $M$ -by-6 array of UTC values, where  $M$  is 2.

Example: [2000 1 12 4 52 12.4;2010 6 5 7 22 0]

Data Types: double



**reduction — Reduction method**

'IAU-2000/2006' (default) | 'IAU-76/FK5'

Reduction method to calculate the coordinate conversion, specified as one of the following:

- 'IAU-76/FK5'

Reduce the calculation using the International Astronomical Union (IAU)-76/Fifth Fundamental Catalogue (FK5) (IAU-76/FK5) reference system. Choose this reduction method if the reference coordinate system for the conversion is FK5. You can use the 'dNutation' Name,Value pair with this reduction.

---

**Note:** This method uses the IAU 1976 precession model and the IAU 1980 theory of nutation to reduce the calculation. This model and theory are no longer current, but the software provides this reduction method for existing implementations. Because of the polar motion approximation that this reduction method uses, lla2eci performs a coordinate conversion that is not orthogonal because of the polar motion approximation.

---

- 'IAU-2000/2006'

Reduce the calculation using the International Astronomical Union (IAU)-2000/2005 reference system. Choose this reduction method if the reference coordinate system for the conversion is IAU-2000. This reduction method uses the P03 precession model to reduce the calculation. You can use the 'dCIP' Name,Value pair with this reduction.

**deltaAT — Difference between International Atomic Time and UTC**

*M*-by-1 array of zeroes (default) | scalar | one-dimensional array

Difference between International Atomic Time (IAT) and UTC, in seconds, for which the function calculates the coordinate conversion.

- scalar

Specify one difference-time value to calculate one direction cosine or transformation matrix.

- one-dimensional array

Specify a one-dimensional array with *M* elements, where *M* is the number of ECI coordinates. Each row corresponds to one set of ECI coordinates.

Specify 32 seconds as the difference between IAT and UTC.

Example: 32

Data Types: double

### **deltaUT1 — Difference between UTC and Universal Time (UT1)**

*M*-by-1 array of zeroes (default) | scalar | one-dimensional array

Difference between UTC and Universal Time (UT1), in seconds, for which the function calculates the coordinate conversion.

- scalar

Specify one difference-time value to calculate ECI coordinates.

- one-dimensional array

Specify a one-dimensional array with *M* elements of difference time values, where *M* is the number of ECI coordinates. Each row corresponds to one set of ECI coordinates.

Specify 0.234 seconds as the difference between UTC and UT1.

Example: 0.234

Data Types: double

### **polarmotion — Polar displacement**

*M*-by-2 array of zeroes (default) | 1-by-2 array | *M*-by-2 array

Polar displacement of the Earth, in radians, from the motion of the Earth crust, along the *x*- and *y*-axes.

- 1-by-2 array

Specify a 1-by-2 array of the polar displacement values to convert one ECI coordinate.

- *M*-by-2 array

Specify an *M*-by-2 array of polar displacement values, where *M* is the number of ECI coordinates to convert. Each row corresponds to one set of UTC values.

Example: [ -0.0682e-5 0.1616e-5 ]

Data Types: double

## Name-Value Pair Arguments

Specify optional comma-separated pairs of `Name`, `Value` arguments. `Name` is the argument name and `Value` is the corresponding value. `Name` must appear inside single quotes (' '). You can specify several name and value pair arguments in any order as `Name1, Value1, . . . , NameN, ValueN`.

Example: 'dNutation', [-0.2530e-6 -0.0188e-6]

### 'dNutation' — Adjustment to longitude (*dDeltaPsi*) and obliquity (*dDeltaEpsilon*)

*M*-by-2 array of zeroes (default) | *M*-by-2 array

Adjustment to the longitude (*dDeltaPsi*) and obliquity (*dDeltaEpsilon*), specified in radians, as the comma-separated pair consisting of `dNutation` and an *M*-by-2 array. You can use this `Name, Value` pair with the IAU-76/FK5 reduction.

For historical values, see the International Earth Rotation and Reference Systems Service website (<http://www.iers.org>) and navigate to the Earth Orientation Data Data/Products page.

- *M*-by-2 array

Specify *M*-by-2 array of adjustment values, where *M* is the number of LLA coordinates to be converted. Each row corresponds to one set of longitude and obliquity values.

Data Types: double

### 'dCIP' — Adjustment to the location of the celestial intermediate pole (CIP)

*M*-by-2 array of zeroes (default) | *M*-by-2 array

Adjustment to the location of the Celestial Intermediate Pole (CIP), in radians, specified as the comma-separated pair consisting of `dCIP` and an *M*-by-2 array. This location (*dDeltaX*, *dDeltaY*) is along the *x*- and *y*- axes. You can use this argument with the IAU-200/2006 reduction. By default, this function assumes an *M*-by-2 array of zeroes.

For historical values, see the International Earth Rotation and Reference Systems Service website (<http://www.iers.org>) and navigate to the Earth Orientation Data Data/Products page.

- *M*-by-2 array

Specify  $M$ -by-2 array of location adjustment values, where  $M$  is the number of LLA coordinates to be converted. Each row corresponds to one set of  $dDeltaX$  and  $dDeltaY$  values.

Example: 'dcip', [-0.2530e-6 -0.0188e-6]

Data Types: double

### **'flattening' — Custom ellipsoid planet**

1-by-1 array

Custom ellipsoid planet defined by flattening.

Example: 1/290

Data Types: double

### **'re' — Custom planet ellipsoid radius**

1-by-1 array

Custom planet ellipsoid radius, in meters.

Example: 60000

Data Types: double

## See Also

### See Also

[dcmeci2ecef](#) | [ecef2lla](#) | [eci2lla](#) | [geoc2geod](#) | [geod2geoc](#) | [lla2ecef](#)

**Introduced in R2014a**

# lla2flat

Convert from geodetic latitude, longitude, and altitude to flat Earth position

## Syntax

```
flatearth_pos = lla2flat(lla, llo, psio, href)
flatearth_pos = lla2flat(lla, llo, psio, href, ellipsoidModel)
flatearth_pos = lla2flat(lla, llo, psio, href, flattening,
equatorialRadius)
```

## Description

`flatearth_pos = lla2flat(lla, llo, psio, href)` estimates an array of flat Earth coordinates, *flatearth\_pos*, from an array of geodetic coordinates, *lla*. This function estimates the *flatearth\_pos* value with respect to a reference location that *llo*, *psio*, and *href* define.

`flatearth_pos = lla2flat(lla, llo, psio, href, ellipsoidModel)` estimates the coordinates for a specific ellipsoid planet.

`flatearth_pos = lla2flat(lla, llo, psio, href, flattening, equatorialRadius)` estimates the coordinates for a custom ellipsoid planet defined by *flattening* and *equatorialRadius*.

## Input Arguments

### lla

*m*-by-3 array of geodetic coordinates (latitude, longitude, and altitude), in [degrees, degrees, meters]. Latitude and longitude values can be any value. However, latitude values of +90 and -90 may return unexpected values because of singularity at the poles.

### Default:

### **llo**

Reference location, in degrees, of latitude and longitude, for the origin of the estimation and the origin of the flat Earth coordinate system.

### **psio**

Angular direction of flat Earth  $x$ -axis (degrees clockwise from north), which is the angle in degrees used for converting flat Earth  $x$  and  $y$  coordinates to the North and East coordinates.

### **href**

Reference height from the surface of the Earth to the flat Earth frame with regard to the flat Earth frame, in meters.

### **ellipsoidModel**

Specific ellipsoid planet model. This function supports only 'WGS84'.

**Default:** WGS84

### **flattening**

Custom ellipsoid planet defined by flattening.

### **equatorialRadius**

Planetary equatorial radius, in meters.

## **Output Arguments**

### **flatearth\_pos**

Flat Earth position coordinates, in meters.

## **Examples**

Estimate coordinates at latitude, longitude, and altitude:

```
p = lla2flat( [ 0.1 44.95 1000 ], [0 45], 5, -100 )
```

```
p =
    1.0e+004 *
    1.0530   -0.6509   -0.0900
```

Estimate coordinates at multiple latitudes, longitudes, and altitudes, specifying the WGS84 ellipsoid model:

```
p = lla2flat( [ 0.1 44.95 1000; -0.05 45.3 2000 ], [0 45], 5, -100, 'WGS84' )
p =
    1.0e+004 *
    1.0530   -0.6509   -0.0900
   -0.2597    3.3751   -0.1900
```

Estimate coordinates at multiple latitudes, longitudes, and altitudes, specifying a custom ellipsoid model:

```
f = 1/196.877360;
Re = 3397000;
p = lla2flat( [ 0.1 44.95 1000; -0.05 45.3 2000 ], [0 45], 5, -100, f, Re )
p =
    1.0e+004 *
    0.5588   -0.3465   -0.0900
   -0.1373    1.7975   -0.1900
```

## Tips

- This function assumes that the flight path and bank angle are zero.
- This function assumes that the flat Earth z-axis is normal to the Earth only at the initial geodetic latitude and longitude. This function has higher accuracy over small distances from the initial geodetic latitude and longitude. It also has higher accuracy at distances closer to the equator. The function calculates a longitude with higher accuracy when the variations in latitude are smaller. Additionally, longitude is singular at the poles.

## Algorithms

The estimation begins by finding the small changes in latitude and longitude from the output latitude and longitude minus the initial latitude and longitude.

$$d\mu = \mu - \mu_0$$

$$d_l = l - l_0$$

To convert geodetic latitude and longitude to the North and East coordinates, the estimation uses the radius of curvature in the prime vertical ( $R_N$ ) and the radius of curvature in the meridian ( $R_M$ ).  $R_N$  and  $R_M$  are defined by the following relationships:

$$R_N = \frac{R}{\sqrt{1 - (2f - f^2) \sin^2 \mu_0}}$$

$$R_M = R_N \frac{1 - (2f - f^2)}{1 - (2f - f^2) \sin^2 \mu_0}$$

where ( $R$ ) is the equatorial radius of the planet and  $f$  is the flattening of the planet.

Small changes in the North (dN) and East (dE) positions are approximated from small changes in the North and East positions by

$$dN = \frac{d\mu}{\text{atan}\left(\frac{1}{R_M}\right)}$$

$$dE = \frac{dl}{\text{atan}\left(\frac{1}{R_N \cos \mu_0}\right)}$$

With the conversion of the North and East coordinates to the flat Earth  $x$  and  $y$  coordinates, the transformation has the form of

$$\begin{bmatrix} p_x \\ p_y \end{bmatrix} = \begin{bmatrix} \cos \psi & \sin \psi \\ -\sin \psi & \cos \psi \end{bmatrix} \begin{bmatrix} N \\ E \end{bmatrix}$$

where

$$(\psi)$$



is the angle in degrees clockwise between the  $x$ -axis and north.

The flat Earth  $z$ -axis value is the negative altitude minus the reference height ( $h_{ref}$ ).

$$p_z = -h - h_{ref}$$

## References

Etkin, B., *Dynamics of Atmospheric Flight*. New York: John Wiley & Sons, 1972.

Stevens, B. L., and F. L. Lewis, *Aircraft Control and Simulation*, 2nd ed. New York: John Wiley & Sons, 2003.

## See Also

flat211a

**Introduced in R2011a**

## load (Aero.Body)

Get geometry data from source

### Syntax

```
load(h, bodyDataSrc)
h.load(bodyDataSrc)
load(h, bodyDataSrc, geometrysource)
h.load(bodyDataSrc, geometrysource)
```

### Description

`load(h, bodyDataSrc)` and `h.load(bodyDataSrc)` load the graphics data from the body graphics file. This command assumes a default geometry source type set to `Auto`.

`load(h, bodyDataSrc, geometrysource)` and `h.load(bodyDataSrc, geometrysource)` load the graphics data from the body graphics file, `bodyDataSrc`, into the face, vertex, and color data of the animation body object `h`. Then, when axes `ax` is available, you can use this data to generate patches with `generatePatches`. `geometrysource` is the geometry source type for the body.

By default *geometrysource* is set to `Auto`, which recognizes `.mat` extensions as MAT-files, `.ac` extensions as Ac3d files, and structures containing fields of `name`, `faces`, `vertices`, and `cdata` as MATLAB variables. If you want to use alternate file extensions or file types, enter one of the following:

- `Auto`
- `Variable`
- `MatFile`
- `Ac3d`
- `Custom`

### Examples

Load the graphic data from the graphic data file, `pa24-250_orange.ac`, into `b`.

```
b=Aero.Body;  
b.load('pa24-250_orange.ac','Ac3d');
```

## See Also

move | generatePatches | update

**Introduced in R2007a**

## **machnumber**

Compute Mach number using velocity and speed of sound

### **Syntax**

```
mach = machnumber(v, a)
```

### **Description**

`mach = machnumber(v, a)` computes `m` Mach numbers, `mach`, from an `m`-by-3 array of velocities, `v`, and an array of `m` speeds of sound, `a`. `v` and `a` must have the same length units.

### **Examples**

Determine the Mach number for velocity and speed of sound in feet per second:

```
mach = machnumber([84.3905 33.7562 10.1269], 1116.4505)
```

```
mach =
```

```
0.0819
```

Determine the Mach number for velocity and speed of sound in meters per second:

```
mach = machnumber([25.7222 10.2889 3.0867], [340.2941 295.0696])
```

```
mach =
```

```
0.0819    0.0945
```

Determine the Mach number for velocity and speed of sound in knots:

```
mach = machnumber([50 20 6; 5 0.5 2], [661.4789 573.5694])
```

mach =

0.0819

0.0094

## See Also

airspeed | alphabeta | dpressure

**Introduced in R2006b**

# mjuliandate

Modified Julian date calculator

## Syntax

```
mjd = mjuliandate(v)
mjd = mjuliandate(s,f)
mjd = mjuliandate(y,mo,d)
mjd = mjuliandate([y,mo,d])
mjd = mjuliandate(y,mo,d,h,mi,s)
mjd = mjuliandate([y,mo,d,h,mi,s])
```

## Description

`mjd = mjuliandate(v)` converts one or more date vectors, `v`, into modified Julian date, `mjd`. Input `v` can be an `m`-by-6 or `m`-by-3 matrix containing `m` full or partial date vectors, respectively. `mjuliandate` returns a column vector of `m` modified Julian dates. Modified Julian dates begin at midnight rather than noon, and the first two digits of its corresponding Julian date are removed.

A date vector contains six elements, specifying year, month, day, hour, minute, and second. A partial date vector has three elements, specifying year, month, and day. Each element of `v` must be a positive double-precision number.

`mjd = mjuliandate(s,f)` converts one or more dates, `s`, into modified Julian date, `mjd`, using format `f`. `s` can be a character array, where each row corresponds to one date character vector, or a one-dimensional cell array of character vectors. `mjuliandate` returns a column vector of `m` modified Julian dates, where `m` is the number of character vectors in `s`.

All of the dates in `s` must have the same format `f`, composed of the same date format symbols as the `datestr` function. `mjuliandate` does not accept formats containing the letter `Q`.

If a format does not contain enough information to compute a date number, then:

- Hours, minutes, and seconds default to 0.

- Days default to 1.
- Months default to January.
- Years default to the current year.

Dates with two-character years are interpreted to be within 100 years of the current year.

`mjd = mjuliandate(y,mo,d)` and `mjd = mjuliandate([y,mo,d])` return the decimal year for corresponding elements of the `y,mo,d` (year,month,day) arrays. Specify `y, mo,` and `d` as one-dimensional arrays of the same length or scalar values.

`mjd = mjuliandate(y,mo,d,h,mi,s)` and `mjd = mjuliandate([y,mo,d,h,mi,s])` return the modified Julian dates for corresponding elements of the `y,mo,d,h,mi,s` (year,month,day,hour,minute,second) arrays. Specify the six arguments as one-dimensional arrays of the same length or scalar values.

## Examples

Calculate the modified Julian date for May 24, 2005:

```
mjd = mjuliandate('24-May-2005', 'dd-mmm-yyyy')
```

```
mjd =
```

```
53514
```

Calculate the modified Julian date for December 19, 2006:

```
mjd = mjuliandate(2006,12,19)
```

```
mjd =
```

```
54088
```

Calculate the modified Julian date for October 10, 2004, at 12:21:00 p.m.:

```
mjd = mjuliandate(2004,10,10,12,21,0)
```

```
mjd =
```

```
5.3289e+004
```

### **Assumptions and Limitations**

This function is valid for all common era (CE) dates in the Gregorian calendar.

The calculation of modified Julian date does not take into account leap seconds.

### **See Also**

`decyear` | `juliandate` | `leapyear`

**Introduced in R2006b**



# moonLibration

Moon librations

## Syntax

```
angles= moonLibration(ephemerisTime)
angles= moonLibration(ephemerisTime,ephemerisModel)
angles= moonLibration(ephemerisTime,ephemerisModel,action)

[angles,rates] = earthNutation( ___ )
```

## Description

`angles= moonLibration(ephemerisTime)` implements the Moon libration angles for `ephemerisTime`, expressed in Julian days.

The function uses the Chebyshev coefficients that the NASA Jet Propulsion Laboratory provides.

This function requires that you download ephemeris data with the Add-On Explorer. For more information, see `aeroDataPackage`.

`angles= moonLibration(ephemerisTime,ephemerisModel)` uses the `ephemerisModel` coefficients to implement these values.

`angles= moonLibration(ephemerisTime,ephemerisModel,action)` uses `action` to determine error reporting.

`[angles,rates] = earthNutation( ___ )` implements the Moon libration angles and rates using any combination of the input arguments in the previous syntaxes.

## Examples

### Implement Libration Angles of Moon

Implement libration angles of the Moon for December 1, 1990 with DE405. Use the `juliandate` function to calculate the input Julian date value.

```
angles = moonLibration(juliandate(1990,12,1))
```

```
angles =  
  1.0e+03 *  
  0.0001    0.0004    1.8010
```

### Implement Libration Angles and Rates for Moon

Specify the ephemerides (DE421) and use the juliandate function for the date (January 1, 2000) to calculate both the Moon libration angles and rates.

```
[angles,rates] = moonLibration([2451544.5 0.5], '421')
```

```
angles =  
  1.0e+03 *  
  -0.0001    0.0004    2.5643  
  
rates =  
  -0.0001    0.0000    0.2301
```

## Input Arguments

### ephemerisTime — Julian dates

scalar | 2-element vector | column vector |  $M$ -by-2 matrix

Julian dates for which the positions are calculated, specified as one of the following:

- Scalar

Specify one fixed Julian date.

- 2-element vector

Specify the Julian date in multiple parts. The first element is the Julian date for a specific epoch that is the most recent midnight at or before the interpolation epoch. The second element is the fractional part of a day elapsed between the first element and epoch. The second element must be positive. The value of the first element plus the second element cannot exceed the maximum Julian date.

- Column vector

Specify a column vector with  $M$  elements, where  $M$  is the number of Julian dates.

- $M$ -by-2 matrix

Specify a matrix, where  $M$  is the number of Julian dates and the second column contains the elapsed days (Julian epoch date/elapsed day pairs).

Data Types: double

### **ephemerisModel** — Ephemerides coefficients

'405' (default) | '421' | '423' | '430' | '432t'

Ephemerides coefficients, specified as one of these ephemerides defined by the Jet Propulsion Laboratory:

- '405'

Released in 1998. This ephemerides takes into account the Julian date range 2305424.50 (December 9, 1599) to 2525008.50 (February 20, 2201).

This function calculates these ephemerides with respect to the International Celestial Reference Frame version 1.0, adopted in 1998.

- '421'

Released in 2008. This ephemerides takes into account the Julian date range 2414992.5 (December 4, 1899) to 2469808.5 (January 2, 2050).

This function calculates these ephemerides with respect to the International Celestial Reference Frame version 1.0, adopted in 1998.

- '423'

Released in 2010. This ephemerides takes into account the Julian date range 2378480.5 (December 16, 1799) to 2524624.5 (February 1, 2200).

This function calculates these ephemerides with respect to the International Celestial Reference Frame version 2.0, adopted in 2010.

- '430'

Released in 2013. This ephemerides takes into account the Julian date range 2287184.5 (December 21, 1549) to 2688976.5 (January 25, 2650).

This block implements these ephemerides with respect to the International Celestial Reference Frame version 2.0, adopted in 2010.

- '432t'

Released in April 2014. This ephemerides takes into account the Julian date range 2287184.5, (December 21, 1549 ) to 2688976.5, (January 25, 2650).

This block implements these ephemerides with respect to the International Celestial Reference Frame version 2.0, adopted in 2010.

Data Types: char

**action — Function behavior**

'Error' (default) | 'None' | 'Warning'

Function behavior when inputs are out of range, specified as one of these values:

Value	Description
'None'	No action.
'Warning'	Warning in the MATLAB Command Window, model simulation continues.
'Error'	MATLAB returns an exception, model simulation stops.

Data Types: char

## Output Arguments

**angles — Moon libration angles**

*M*-by-3 numeric array

Moon libration angles, specified as an *M*-by-3 numeric array. *M* is the number of Julian dates, in rows. The columns contain the Euler angles ( $\varphi$   $\theta$   $\psi$ ) for Moon attitude, in radians.

If the input arguments include multiple Julian dates or epochs, this array has the same number of rows as the `ephemerisTime` input.

**rates — Moon libration angular rates**

*M*-by-3 numeric array

Moon libration angular rates, specified as an *M*-by-3 numeric array. *M* is the number of Julian dates, in rows. The columns contain the Moon libration Euler angular rates ( $\omega$ ), in radians/day.

If the input arguments include multiple Julian dates or epochs, this array has the same number of rows as the `ephemerisTime` input.

## References

- [1] Folkner, W. M., J. G. Williams, D. H. Boggs, “The Planetary and Lunar Ephemeris DE 421,” *JPL Interplanetary Network Progress Report 24-178*, 2009.
- [2] Vallado, D. A., *Fundamentals of Astrodynamics and Applications*, McGraw-Hill, New York, 1997.

## See Also

### See Also

`earthNutation` | `juliandate` | `planetEphemeris`

### External Websites

[http://ssd.jpl.nasa.gov/?planet\\_eph\\_export](http://ssd.jpl.nasa.gov/?planet_eph_export)

<http://syrte.obspm.fr/jsr/journees2010/powerpoint/folkner.pdf>

**Introduced in R2013a**

## move (Aero.Body)

Change animation body position and orientation

### Syntax

```
move(h, translation, rotation)  
h.move(translation,rotation)
```

### Description

`move(h, translation, rotation)` and `h.move(translation,rotation)` set a new position and orientation for the body object `h`. `translation` is a 1-by-3 matrix in the aerospace body *x-y-z* coordinate system. `rotation` is a 1-by-3 matrix, in radians, that specifies the rotations about the right-hand *x-y-z* sequence of coordinate axes. The order of application of the rotation is *z-y-x* (*r-q-p*).

### Examples

Change animation body position to *newpos* and *newrot*.

```
h = Aero.Body;  
h.load('ac3d_xyzisrgb.ac','Ac3d');  
newpos = h.Position + 1.00;  
newrot = h.Rotation + 0.01;  
h.move(newpos,newrot);
```

### See Also

load

Introduced in R2007a

## move (Aero.Node)

Change node translation and rotation

### Syntax

```
move(h,translation,rotation)
h.move(translation,rotation)
```

### Description

`move(h,translation,rotation)` and `h.move(translation,rotation)` set a new position and orientation for the node object `h`. `translation` is a 1-by-3 matrix in the aerospace body  $x$ - $y$ - $z$  coordinate system or another coordinate system. In the latter case, you can use the `CoordTransformFcn` function to move it into an aerospace body. The defined aerospace body coordinate system is defined relative to the screen as  $x$ -left,  $y$ -in,  $z$ -down.

`rotation` is a 1-by-3 matrix, in radians, that specifies the rotations about the right-hand  $x$ - $y$ - $z$  sequence of coordinate axes. The order of application of the rotation is  $z$ - $y$ - $x$  ( $r$ - $q$ - $p$ ). This function uses the `CoordTransformFcn` to apply the translation and rotation from the input coordinate system to the aerospace body. The function then moves the translation and rotation from the aerospace body to the VRML  $x$ - $y$ - $z$  coordinates. The defined VRML coordinate system is defined relative to the screen as  $x$ -right,  $y$ -up,  $z$ -out.

### Examples

Move the Lynx body. This example uses the Simulink 3D Animation `vrnode/getfield` function to retrieve the translation and rotation. These coordinates are those used in the Simulink 3D Animation software.

```
h = Aero.VirtualRealityAnimation;
h.VRWorldFilename = [matlabroot, '/toolbox/aero/astdemos/asttkoff.wrl'];
copyfile(h.VRWorldFilename,[tempdir,'asttkoff.wrl'],'f');
h.VRWorldFilename = [tempdir,'asttkoff.wrl'];
h.initialize();
newtrans = getfield(h.Nodes{4}.VRNode,'translation') + 1.0;
newrot = getfield(h.Nodes{4}.VRNode,'rotation') + [.2 0.01 0.01 0.01];
```

```
h.Nodes{4}.move(newtrans,newrot);
```

### Limitations

This function cannot get the node position in aerospace body coordinates; it needs to use the `CoordTransformFcn` to do so.

This function cannot set a viewpoint position or orientation (see `addViewpoint`).

### See Also

`addNode`

**Introduced in R2007b**



# moveBody

**Class:** Aero.Animation

**Package:** Aero

Move body in animation object

## Syntax

```
moveBody(h,idx,translation,rotation)
h.moveBody(idx,translation,rotation)
```

## Description

`moveBody(h,idx,translation,rotation)` and `h.moveBody(idx,translation,rotation)` set a new position and attitude for the body specified with the index `idx` in the animation object `h`. `translation` is a 1-by-3 matrix in the aerospace body coordinate system. `rotation` is a 1-by-3 matrix, in radians, that specifies the rotations about the right-hand  $x$ - $y$ - $z$  sequence of coordinate axes. The order of application of the rotation is  $z$ - $y$ - $x$  ( $R$ - $Q$ - $P$ ).

## Input Arguments

<code>h</code>	Animation object.
<code>translation</code>	1-by-3 matrix in the aerospace body coordinate system.
<code>rotation</code>	1-by-3 matrix, in radians, that specifies the rotations about the right-hand $x$ - $y$ - $z$ sequence of coordinate axes.
<code>idx</code>	Body specified with this index.

## Examples

Move the body with the index 1 to position offset from the original by `+ [0 0 -3]` and rotation, `rot1`.

```
h = Aero.Animation;  
idx1 = h.createBody('pa24-250_orange.ac', 'Ac3d');  
pos1 = h.Bodies{1}.Position;  
rot1 = h.Bodies{1}.Rotation;  
h.moveBody(1, pos1 + [0 0 -3], rot1);
```

## Node (Aero.Node)

Create node object for use with virtual reality animation

### Syntax

```
h = Aero.Node
```

### Description

`h = Aero.Node` creates a node object for use with virtual reality animation.

See `Aero.Node` for further details.

### See Also

`Aero.Node`

**Introduced in R2007b**

## **nodeInfo (Aero.VirtualRealityAnimation)**

Create list of nodes associated with virtual reality animation object

### **Syntax**

```
nodeInfo(h)  
h.nodeInfo  
n = nodeInfo(h)  
n = h.nodeInfo
```

### **Description**

`nodeInfo(h)` and `h.nodeInfo` create a list of nodes associated with the virtual reality animation object, `h`.

`n = nodeInfo(h)` and `n = h.nodeInfo` create a cell array (`n`) that contains the node information. The function stores the information in a cell array as follows:

```
N{1,n} = Node Index  
N{2,n} = Node Name  
N{3,n} = Node Type
```

where `n` is the number of nodes. You might want to use this function to find an existing node by name and then perform a certain action on it using the node index.

### **Examples**

Create list of nodes associated with virtual reality animation object, `h`.

```
h = Aero.VirtualRealityAnimation;  
h.VRWorldFilename = [matlabroot, '/toolbox/aero/astdemos/asttkoff.wrl'];  
h.initialize();  
h.nodeInfo;
```

### **See Also**

`addNode`

**Introduced in R2007b**

## planetEphemeris

Position and velocity of astronomical objects

### Syntax

```
position= planetEphemeris(ephemerisTime,center,target)
position = planetEphemeris(ephemerisTime,center,target,
ephemerisModel)
position = planetEphemeris(ephemerisTime,center,target,
ephemerisModel,units)
position= planetEphemeris(ephemerisTime,center,target,
ephemerisModel,units,action)
```

```
[position,velocity] = planetEphemeris( ___ )
```

### Description

`position= planetEphemeris(ephemerisTime,center,target)` implements the position of the target object relative to the specified center object for a given Julian date `ephemerisTime`. By default, the function implements the position based on the DE405 ephemerides in units of km.

The function uses the Chebyshev coefficients that the NASA Jet Propulsion Laboratory provides.

This function requires that you download ephemeris data with the Add-On Explorer. For more information, see [aeroDataPackage](#).

`position = planetEphemeris(ephemerisTime,center,target,ephemerisModel)` uses the `ephemerisModel` coefficients to implement these values.

`position = planetEphemeris(ephemerisTime,center,target,ephemerisModel,units)` specifies the units for these values.

`position= planetEphemeris(ephemerisTime,center,target,ephemerisModel,units,action)` uses `action` to determine error reporting.

`[position,velocity] = planetEphemeris(____)` implements the position and velocity of a the target object relative to the specified center for a given Julian date `ephemerisTime` using any of the input arguments in the previous syntaxes.

## Examples

### Implement Position of Moon

Implement the position of the Moon with respect to the Earth for December 1, 1990 with DE405:

```
position = planetEphemeris(juliandate(1990,12,1), 'Earth', 'Moon')

position =
    1.0e+05 *
    2.3112    2.3817    1.3595
```

### Implement Position and Velocity for Saturn

Implement the position and velocity for Saturn with respect to the Solar System barycenter for noon on January 1, 2000 using DE421 and AU units:

```
[position,velocity] = planetEphemeris([2451544.5 0.5],...
    'SolarSystem', 'Saturn', '421', 'AU')

position =
    6.3993    6.1720    2.2738
velocity =
   -0.0043    0.0035    0.0016
```

## Input Arguments

### **ephemerisTime** — Julian date

scalar | 2-element vector | column vector |  $M$ -by-2 matrix

Julian date for which the positions are calculated, specified as one of the following:

- Scalar
  - Specify one fixed Julian date.
- 2-element vector

Specify the Julian date in multiple parts. The first element is the Julian date for a specific epoch that is the most recent midnight at or before the interpolation epoch. The second element is the fractional part of a day elapsed between the first element and epoch. The second element must be positive. The value of the first element plus the second element cannot exceed the maximum Julian date.

- Column vector

Specify a column vector with  $M$  elements, where  $M$  is the number of fixed Julian dates.

- $M$ -by-2 matrix

Specify a matrix, where  $M$  is the number of Julian dates and the second column contains the elapsed days (Julian epoch date/elapsed day pairs).

Data Types: double

### **center** — Reference body (astronomical object) or point of reference

'Sun' | 'Mercury' | 'Venus' | 'Earth' | 'Moon' | 'Mars' | 'Jupiter' |  
'Saturn' | 'Uranus' | 'Neptune' | 'Pluto' | 'SolarSystem' | 'EarthMoon'

Reference body (astronomical object) or point of reference from which to measure the target barycenter position and velocity.

Data Types: char

### **target** — Target body (astronomical object) or point of reference

'Sun' | 'Mercury' | 'Venus' | 'Earth' | 'Moon' | 'Mars' | 'Jupiter' |  
'Saturn' | 'Uranus' | 'Neptune' | 'Pluto' | 'SolarSystem' | 'EarthMoon'

Target body (astronomical object) or point of reference of the barycenter position and velocity measurement.

Data Types: char

### **ephemerisModel** — Ephemerides coefficients

'405' (default) | '421' | '423' | '430' | '432t'

Ephemerides coefficients, specified as one of these ephemerides defined by the Jet Propulsion Laboratory:

- '405'



Released in 1998. This ephemerides takes into account the Julian date range 2305424.50 (December 9, 1599 ) to 2525008.50 (February 20, 2201).

This function calculates these ephemerides with respect to the International Celestial Reference Frame version 1.0, adopted in 1998.

- '421'

Released in 2008. This ephemerides takes into account the Julian date range 2414992.5 (December 4, 1899) to 2469808.5 (January 2, 2050).

This function calculates these ephemerides with respect to the International Celestial Reference Frame version 1.0, adopted in 1998.

- '423'

Released in 2010. This ephemerides takes into account the Julian date range 2378480.5 (December 16, 1799) to 2524624.5 (February 1, 2200).

This function calculates these ephemerides with respect to the International Celestial Reference Frame version 2.0, adopted in 2010.

- '430'

Released in 2013. This ephemerides takes into account the Julian date range 2287184.5 (December 21, 1549) to 2688976.5 (January 25, 2650).

This block implements these ephemerides with respect to the International Celestial Reference Frame version 2.0, adopted in 2010.

- '432t'

Released in April 2014. This ephemerides takes into account the Julian date range 2287184.5, (December 21, 1549 ) to 2688976.5, (January 25, 2650).

This block implements these ephemerides with respect to the International Celestial Reference Frame version 2.0, adopted in 2010.

Data Types: char

### **units — Output units**

' km ' (default) | ' AU '

Output units for position and velocity, specified as 'km' for km and km/s or 'AU' for astronomical units or AU/day.

Data Types: char

**action — Function behavior**

'Error' (default) | 'None' | 'Warning'

Function behavior when inputs are out of range.

Value	Description
'None'	No action.
'Warning'	Warning in the MATLAB Command Window, model simulation continues.
'Error'	MATLAB returns an exception, model simulation stops.

Data Types: char

## Output Arguments

**position — Barycenter position**

*M*-by-3 vector

Barycenter position of the `target` object relative to the barycenter of the `center` object, returned as an *M*-by-3 vector, where *M* is the number of Julian dates. The 3 vector contains the *x*, *y*, and *z* of the position along the International Celestial Reference Frame (ICRF). Units are km or astronomical units (AU). If input arguments include multiple Julian dates or epochs, this vector has the same number of rows as the `ephemerisTime` input.

**velocity — Barycenter velocity**

*M*-by-3 vector

Barycenter velocity of the `target` object relative to the barycenter of the `center` object, returned as an *M*-by-3 vector, where *M* is the number of Julian dates. The 3 vector contains the velocity in the *x*, *y*, and *z* directions along the ICRF. Velocity of the Units are km or astronomical units (AU). If the input includes multiple Julian dates or epochs, this vector has the same number of rows as the `ephemerisTime` input.

## References

- [1] Folkner, W. M., J. G. Williams, D. H. Boggs, “The Planetary and Lunar Ephemeris DE 421,” *JPL Interplanetary Network Progress Report 24-178*, 2009.
- [2] Ma, C. et al., “The International Celestial Reference Frame as Realized by Very Long Baseline Interferometry,” *Astronomical Journal*, Vol. 116, 516–546, 1998.
- [3] Vallado, D. A., *Fundamentals of Astrodynamics and Applications*, McGraw-Hill, New York, 1997.

## See Also

### See Also

`earthNutation` | `juliandate` | `moonLibration`

### External Websites

[http://ssd.jpl.nasa.gov/?planet\\_eph\\_export](http://ssd.jpl.nasa.gov/?planet_eph_export)

**Introduced in R2013a**

# play

**Class:** Aero.Animation

**Package:** Aero

Animate Aero.Animation object given position/angle time series

## Syntax

```
play(h)  
h.play
```

## Description

`play(h)` and `h.play` animate the loaded geometry in `h` for the current `TimeseriesDataSource` at the specified rate given by the `'TimeScaling'` property (in seconds of animation data per second of wall-clock time) and animated at a certain number of frames per second using the `'FramesPerSecond'` property.

The time series data is interpreted according to the `'TimeseriesSourceType'` property, which can be one of:

`'Timeseries'` MATLAB time series data with six values per time:

```
x y z phi theta psi
```

The values are resampled.

`'Simulink.Timeseries'` Simulink.Timeseries (Simulink signal logging):

- First data item

```
x y z
```

- Second data item

```
phi theta psi
```

`'StructureWithTimeSeries'` Simulink struct with time (for example, Simulink root output logging `'Structure with time'`):

- `signals(1).values: x y z`
- `signals(2).values: phi theta psi`

Signals are linearly interpolated vs. time using `interp1`.

'Array6DoF'	A double-precision array in <code>n</code> rows and 7 columns for 6-DoF data: <code>time x y z phi theta psi</code> . If a double-precision array of 8 or more columns is in 'TimeseriesSource', the first 7 columns are used as 6-DoF data.
'Array3DoF'	A double-precision array in <code>n</code> rows and 4 columns for 3-DoF data: <code>time x z theta</code> . If a double-precision array of 5 or more columns is in 'TimeseriesSource', the first 4 columns are used as 3-DoF data.
'Custom'	Position and angle data is retrieved from 'TimeseriesSource' by the currently registered 'TimeseriesReadFcn'.

The following are limitations for the `TStart` and `TFinal` values:

- `TStart` and `TFinal` must be numeric.
- `TStart` and `TFinal` cannot be `Inf` or `NaN`.
- `TFinal` must be greater than or equal to `TStart`.
- `TFinal` cannot be greater than the maximum `Timeseries` time.
- `TStart` cannot be less than the minimum `Timeseries` time.

The time advancement algorithm used by `play` is based on animation frames counted by ticks:

```
ticks = ticks + 1;
time = tstart + ticks*FramesPerSecond*TimeScaling;
```

where

<code>TimeScaling</code>	Specify the seconds of animation data per second of wall-clock time.
<code>FramesPerSecond</code>	Specify the number of frames per second used to animate the 'TimeseriesSource'.

For default 'TimeseriesReadFcn' methods, the last frame played is the last time value.

Time is in seconds, position values are in the same units as the geometry data loaded into the animation object, and all angles are in radians.

---

**Note** If there is a 15% difference between the expected time advance and the actual time advance, this method will generate the following warning:

TimerPeriod has been set to <value>. You may wish to modify the animation TimeScaling and FramesPerSecond properties to compensate for the millisecond limit of the TimerPeriod. See documentation for details.

---

## Input Arguments

h                      Animation object.

## Examples

Animate the body, `idx1`, for the duration of the time series data.

```
h = Aero.Animation;
h.FramesPerSecond = 10;
h.TimeScaling = 5;
idx1 = h.createBody('pa24-250_orange.ac', 'Ac3d');
load simdata;
h.Bodies{1}.TimeSeriesSource = simdata;
h.show();
h.play();
```

## play (Aero.FlightGearAnimation)

Animate FlightGear flight simulator using given position/angle time series

### Syntax

```
play(h)
h.play
```

### Description

`play(h)` and `h.play` animate FlightGear flight simulator using specified time series data in `h`. The time series data can be set in `h` by using the property `'TimeseriesSource'`.

The time series data, stored in the property `'TimeseriesSource'`, is interpreted according to the `'TimeseriesSourceType'` property, which can be one of:

<code>'Timeseries'</code>	MATLAB time series data with six values per time:  latitude longitude altitude phi theta psi  The values are resampled.
<code>'StructureWithTimeSeries'</code>	Simulink struct with time (for example, Simulink root output logging <code>'Structure with time'</code> ): <ul style="list-style-type: none"> <li><code>signals(1).values</code>: latitude longitude altitude</li> <li><code>signals(2).values</code>: phi theta psi</li> </ul> Signals are linearly interpolated vs. time using <code>interp1</code> .
<code>'Array6DoF'</code>	A double-precision array in <code>n</code> rows and 7 columns for 6-DoF data: time latitude longitude altitude phi theta psi. If a double-precision array of 8 or more columns is in <code>'TimeseriesSource'</code> , the first 7 columns are used as 6-DoF data.

'Array3DoF'	A double-precision array in $n$ rows and 4 columns for 3-DoF data: <code>time latitude altitude theta</code> . If a double-precision array of 5 or more columns is in 'TimeseriesSource', the first 4 columns are used as 3-DoF data.
'Custom'	Position and angle data is retrieved from 'TimeseriesSource' by the currently registered 'TimeseriesReadFcn'.

The time advancement algorithm used by `play` is based on animation frames counted by ticks:

```
ticks = ticks + 1;  
time = tstart + ticks*FramesPerSecond*TimeScaling;
```

where

TimeScaling	Specify the seconds of animation data per second of wall-clock time.
FramesPerSecond	Specify the number of frames per second used to animate the 'TimeseriesSource'.

For default 'TimeseriesReadFcn' methods, the last frame played is the last time value.

Time is in seconds, position values are in the same units as the geometry model to be used by FlightGear (see the property 'GeometryModelName'), and all angles are in radians. A possible result of using incorrect units is the early termination of the FlightGear flight simulator.

---

**Note** If there is a 15% difference between the expected time advance and the actual time advance, this method will generate the following warning:

```
TimerPeriod has been set to <value>. You may wish to modify the animation  
TimeScaling and FramesPerSecond properties to compensate for the  
millisecond limit of the TimerPeriod. See documentation for details.
```

---

The `play` method supports FlightGear animation objects with custom timers.

## Limitations

The following are limitations for the `TStart` and `TFinal` values:



- `TStart` and `TFinal` must be numeric.
- `TStart` and `TFinal` cannot be `Inf` or `NaN`.
- `TFinal` must be greater than or equal to `TStart`.
- `TFinal` cannot be greater than the maximum `Timeseries` time.
- `TStart` cannot be less than the minimum `Timeseries` time.

## Examples

Animate FlightGear flight simulator using the given 'Array3DoF' position/angle time series data:

```
data = [86.2667 -2.13757034184404 7050.896596 -0.135186746141248;...
      87.2833 -2.13753906554384 6872.545051 -0.117321084678936;...
      88.2583 -2.13751089592972 6719.405713 -0.145815609299676;...
      89.275 -2.13747984652232 6550.117118 -0.150635248762596;...
      90.2667 -2.13744993157894 6385.05883 -0.143124782831999;...
      91.275 -2.13742019116849 6220.358163 -0.147946202530756;...
      92.275 -2.13739055547779 6056.906647 -0.167529704309343;...
      93.2667 -2.13736104196014 5892.356118 -0.152547361677911;...
      94.2583 -2.13733161570895 5728.201718 -0.161979312941906;...
      95.2583 -2.13730231163081 5562.923808 -0.122276929636682;...
      96.2583 -2.13727405475022 5406.736322 -0.160421658944379;...
      97.2667 -2.1372440001805 5239.138477 -0.150591353731908;...
      98.2583 -2.13721598764601 5082.78798 -0.147737722951605];
h = fganimation
h.TimeseriesSource = data
h.TimeseriesSourceType = 'Array3DoF'
play(h)
```

Animate FlightGear flight simulator using the custom timer, `MyFGTimer`.

```
h.SetTimer('MyFGTimer')
h.play('MyFGTimer')
```

## See Also

[GenerateRunScript](#) | [initialize](#) | [update](#)

**Introduced in R2007a**

## play (Aero.VirtualRealityAnimation)

Animate virtual reality world for given position and angle in time series data

### Syntax

```
play(h)  
h.play
```

### Description

`play(h)` and `h.play` animate the virtual reality world in `h` for the current `TimeseriesDataSource` at the specified rate given by the `'TimeScaling'` property (in seconds of animation data per second of wall-clock time) and animated at a certain number of frames per second using the `'FramesPerSecond'` property.

The time series data is interpreted according to the `'TimeseriesSourceType'` property, which can be one of:

`'timeseries'` MATLAB time series data with six values per time:

```
x y z phi theta psi
```

The values are resampled.

`'Simulink.Timeseries'` Simulink.Timeseries (Simulink signal logging):

- First data item

```
x y z
```

- Second data item

```
phi theta psi
```

`'StructureWithTime'` Simulink struct with time (for example, Simulink root output logging `'Structure with time'`):

- `signals(1).values: x y z`
- `signals(2).values: phi theta psi`

	Signals are linearly interpolated vs. time using <code>interp1</code> .
'Array6DoF'	A double-precision array in $n$ rows and 7 columns for 6-DoF data: <code>time x y z phi theta psi</code> . If a double-precision array of 8 or more columns is in 'TimeseriesSource', the first 7 columns are used as 6-DoF data.
'Array3DoF'	A double-precision array in $n$ rows and 4 columns for 3-DoF data: <code>time x z theta</code> . If a double-precision array of 5 or more columns is in 'TimeseriesSource', the first 4 columns are used as 3-DoF data.
'Custom'	Position and angle data is retrieved from 'TimeseriesSource' by the currently registered 'TimeseriesReadFcn'.

The time advancement algorithm used by `play` is based on animation frames counted by ticks:

```
ticks = ticks + 1;
time = tstart + ticks*FramesPerSecond*TimeScaling;
```

where

<code>TimeScaling</code>	Specify the seconds of animation data per second of wall-clock time.
<code>FramesPerSecond</code>	Specify the number of frames per second used to animate the 'TimeseriesSource'.

For default 'TimeseriesReadFcn' methods, the last frame played is the last time value.

Time is in seconds, position values are in the same units as the geometry data loaded into the animation object, and all angles are in radians.

## Examples

Animate virtual reality world, `asttkoff`.

```
h = Aero.VirtualRealityAnimation;
h.FramesPerSecond = 10;
h.TimeScaling = 5;
h.VRWorldFilename = [matlabroot, '/toolbox/aero/astdemos/asttkoff.wrl'];
copyfile(h.VRWorldFilename, [tempdir, 'asttkoff.wrl'], 'f');
```

```
h.VRWorldFilename = [tempdir,'asttkoff.wrl'];
h.initialize();
load takeoffData
[~, idxPlane] = find(strcmp('Plane', h.nodeInfo));
h.Nodes{idxPlane}.TimeseriesSource = takeoffData;
h.Nodes{idxPlane}.TimeseriesSourceType = 'StructureWithTime';
h.Nodes{idxPlane}.CoordTransformFcn = @vranimCustomTransform;
h.play();
```

### See Also

`initialize`

**Introduced in R2007b**

# quat2angle

Convert quaternion to rotation angles

## Syntax

```
[r1 r2 r3] = quat2angle(q)  
[r1 r2 r3] = quat2angle(q, s)
```

## Description

`[r1 r2 r3] = quat2angle(q)` calculates the set of rotation angles, `r1`, `r2`, `r3`, for a given quaternion, `q`. `q` is an `m`-by-4 matrix containing `m` quaternions. Each element of `q` must be a real number. `q` has its scalar number as the first column.

Rotation angles are output in radians.

`r1`

Returns an `m` array of first rotation angles.

`r2`

Returns an `m` array of second rotation angles.

`r3`

Returns an `m` array of third rotation angles.

`[r1 r2 r3] = quat2angle(q, s)` calculates the set of rotation angles, `r1`, `r2`, `r3`, for a given quaternion, `q`, and a specified rotation sequence, `s`.

The default rotation sequence is 'ZYX', where `r1` is z-axis rotation, `r2` is y-axis rotation, and `r3` is x-axis rotation.

Supported rotation sequences are 'ZYX', 'ZYZ', 'ZXY', 'ZXZ', 'YXZ', 'YXY', 'YZX', 'YZY', 'XYZ', 'YXY', 'XZY', and 'XZX'.

## Examples

Determine the rotation angles from `q = [1 0 1 0]`.

```
[yaw, pitch, roll] = quat2angle([1 0 1 0])
yaw =
    0
pitch =
    1.5708
roll =
    0
```

Determine the rotation angles from multiple quaternions.

```
q = [1 0 1 0; 1 0.5 0.3 0.1];
[pitch, roll, yaw] = quat2angle(q, 'YXZ')
pitch =
    1.5708
    0.8073
roll =
    0
    0.7702
yaw =
    0
    0.5422
```

## Assumptions and Limitations

The limitations for the 'ZYX', 'ZXY', 'YXZ', 'YZX', 'XYZ', and 'XZY' implementations generate an  $r2$  angle that lies between  $\pm 90$  degrees, and  $r1$  and  $r3$  angles that lie between  $\pm 180$  degrees.

The limitations for the 'YZX', 'ZXZ', 'YXY', 'YZY', 'XYX', and 'XZX' implementations generate an  $r2$  angle that lies between 0 and 180 degrees, and  $r1$  and  $r3$  angles that lie between  $\pm 180$  degrees.

## See Also

[angle2dcm](#) | [angle2quat](#) | [dcm2angle](#) | [dcm2quat](#) | [quat2dcm](#)

**Introduced in R2007b**

# quat2dcm

Convert quaternion to direction cosine matrix

## Syntax

```
n = quat2dcm(q)
```

## Description

`n = quat2dcm(q)` calculates the direction cosine matrix, `n`, for a given quaternion, `q`. Input `q` is an `m`-by-4 matrix containing `m` quaternions. `n` returns a 3-by-3-by-`m` matrix of direction cosine matrices. The direction cosine matrix performs the coordinate transformation of a vector in inertial axes to a vector in body axes. Each element of `q` must be a real number. Additionally, `q` has its scalar number as the first column.

## Examples

Determine the direction cosine matrix from `q = [1 0 1 0]`:

```
dcm = quat2dcm([1 0 1 0])
```

```
dcm =
```

```

      0      0  -1.0000
      0  1.0000      0
  1.0000      0      0
```

Determine the direction cosine matrices from multiple quaternions:

```
q = [1 0 1 0; 1 0.5 0.3 0.1];
dcm = quat2dcm(q)
```

```
dcm(:,:,1) =
```

```

      0      0  -1.0000
```

```
      0      1.0000      0
1.0000      0      0
```

```
dcm(:, :, 2) =
```

```
 0.8519  0.3704 -0.3704
 0.0741  0.6148  0.7852
 0.5185 -0.6963  0.4963
```

### See Also

[angle2dcm](#) | [dcm2angle](#) | [dcm2quat](#) | [angle2quat](#) | [quat2angle](#) | [quatrotate](#)

**Introduced in R2006b**



# quat2rod

Convert quaternion to Euler-Rodrigues vector

## Syntax

```
rod=quat2rod(quat)
```

## Description

`rod=quat2rod(quat)` function calculates the Euler-Rodrigues vector, `rod`, for a given quaternion `quat`.

## Examples

### Determine Euler-Rodrigues Vector from Quaternion

Determine the Euler-Rodrigues vector from the quaternion.

```
q = [-0.7071 0 0.7071 0]
r = quat2rod( q )
```

```
q =
```

```
    -0.7071         0    0.7071         0
r =
```

```
         0    -1.0000         0
```

## Input Arguments

### **quat** — Quaternion

*M*-by-4 array

*M*-by-4 array of quaternions. `quat` has its scalar number as the first column.

Data Types: double

## Output Arguments

**rod** — Euler-Rodrigues vector

*M*-by-3 matrix

*M*-by-3 matrix containing *M* Euler-Rodrigues vectors.

## Algorithms

An Euler-Rodrigues vector  $\bar{b}$  represents a rotation by integrating a direction cosine of a rotation axis with the tangent of half the rotation angle as follows:

$$\bar{b} = [b_x \quad b_y \quad b_z]$$

where:

$$b_x = \tan\left(\frac{1}{2}\theta\right)s_x,$$

$$b_y = \tan\left(\frac{1}{2}\theta\right)s_y,$$

$$b_z = \tan\left(\frac{1}{2}\theta\right)s_z$$

are the Rodrigues parameters. Vector  $\bar{s}$  represents a unit vector around which the rotation is performed. Due to the tangent, the rotation vector is indeterminate when the rotation angle equals  $\pm\pi$  radians or  $\pm 180$  deg. Values can be negative or positive.

## References

- [1] Dai, J.S. "Euler-Rodrigues formula variations, quaternion conjugation and intrinsic connections." *Mechanism and Machine Theory*, 92, 144-152. Elsevier, 2015.

## See Also

### See Also

[angle2rod](#) | [dcm2rod](#) | [rod2angle](#) | [rod2dcm](#) | [rod2quat](#)

**Introduced in R2017a**

## quatconj

Calculate conjugate of quaternion

### Syntax

`n = quatconj(q)`

### Description

`n = quatconj(q)` calculates the conjugate, `n`, for a given quaternion, `q`. Input `q` is an `m`-by-4 matrix containing `m` quaternions. `n` returns an `m`-by-4 matrix of conjugates. Each element of `q` must be a real number. Additionally, `q` has its scalar number as the first column.

The quaternion has the form of

$$q = q_0 + \mathbf{i}q_1 + \mathbf{j}q_2 + \mathbf{k}q_3$$

The quaternion conjugate has the form of

$$q' = q_0 - \mathbf{i}q_1 - \mathbf{j}q_2 - \mathbf{k}q_3$$

### Examples

Determine the conjugate of `q = [1 0 1 0]`:

```
conj = quatconj([1 0 1 0])
```

```
conj =
```

```
1     0    -1     0
```

## References

- [1] Stevens, Brian L., Frank L. Lewis, *Aircraft Control and Simulation*, Wiley–Interscience, 2nd Edition.

## Extended Capabilities

### C/C++ Code Generation

Generate C and C++ code using MATLAB® Coder™.

Usage notes and limitations:

Code generation for this function requires the Aerospace Blockset software.

### See Also

`quatdivide` | `quatinv` | `quatmod` | `quatmultiply` | `quatnorm` | `quatnormalize` | `quatrotate`

**Introduced in R2006b**

## quatdivide

Divide quaternion by another quaternion

### Syntax

`n = quatdivide(q,r)`

### Description

`n = quatdivide(q,r)` calculates the result of quaternion division, `n`, for two given quaternions, `q` and `r`. Inputs `q` and `r` can each be either an `m`-by-4 matrix containing `m` quaternions, or a single 1-by-4 quaternion. `n` returns an `m`-by-4 matrix of quaternion quotients. Each element of `q` and `r` must be a real number. Additionally, `q` and `r` have their scalar number as the first column.

The quaternions have the form of

$$q = q_0 + \mathbf{i}q_1 + \mathbf{j}q_2 + \mathbf{k}q_3$$

and

$$r = r_0 + \mathbf{i}r_1 + \mathbf{j}r_2 + \mathbf{k}r_3$$

The resulting quaternion from the division has the form of

$$t = \frac{q}{r} = t_0 + \mathbf{i}t_1 + \mathbf{j}t_2 + \mathbf{k}t_3$$

where

$$t_0 = \frac{(r_0q_0 + r_1q_1 + r_2q_2 + r_3q_3)}{r_0^2 + r_1^2 + r_2^2 + r_3^2}$$

$$t_1 = \frac{(r_0q_1 - r_1q_0 - r_2q_3 + r_3q_2)}{r_0^2 + r_1^2 + r_2^2 + r_3^2}$$

$$t_2 = \frac{(r_0q_2 + r_1q_3 - r_2q_0 - r_3q_1)}{r_0^2 + r_1^2 + r_2^2 + r_3^2}$$

$$t_3 = \frac{(r_0q_3 - r_1q_2 + r_2q_1 - r_3q_0)}{r_0^2 + r_1^2 + r_2^2 + r_3^2}$$

## Examples

Determine the division of two 1-by-4 quaternions:

```
q = [1 0 1 0];
r = [1 0.5 0.5 0.75];
d = quatdivide(q, r)
```

d =

```
0.7273    0.1212    0.2424   -0.6061
```

Determine the division of a 2-by-4 quaternion by a 1-by-4 quaternion:

```
q = [1 0 1 0; 2 1 0.1 0.1];
r = [1 0.5 0.5 0.75];
d = quatdivide(q, r)
```

d =

```
0.7273    0.1212    0.2424   -0.6061
1.2727    0.0121   -0.7758   -0.4606
```

## References

- [1] Stevens, Brian L., Frank L. Lewis, *Aircraft Control and Simulation*, Wiley–Interscience, 2nd Edition.

## Extended Capabilities

### C/C++ Code Generation

Generate C and C++ code using MATLAB® Coder™.

Usage notes and limitations:

Code generation for this function requires the Aerospace Blockset software.

### See Also

`quatconj` | `quatinv` | `quatmod` | `quatmultiply` | `quatnorm` | `quatnormalize` | `quatrotate`

**Introduced in R2006b**



## quatexp

Exponential of quaternion

### Syntax

```
qe=quatexp(q)
```

### Description

qe=quatexp(q) calculates the exponential, qe, for the specified quaternion, q.

### Examples

#### Calculate the Exponential of Quaternion

Calculate the exponentials of quaternion matrix [0 0 0.7854 0].

```
qe = quatexp([0 0 0.7854 0])
```

```
qe =  
    0.7071         0    0.7071         0
```

### Input Arguments

#### q — Quaternions

*M*-by-4 matrix

Quaternions for which to calculate exponentials, specified as an *M*-by-4 matrix containing *M* quaternions.

Data Types: double

### Output Arguments

#### qe — Exponential of quaternion

*M*-by-4 matrix

Exponential of quaternion.

## **See Also**

### **See Also**

quatconj | quatdivide | quatinterp | quatinv | quatlog | quatmod |  
quatmultiply | quatnormalize | quatpower | quatrotate

### **External Websites**

<http://web.mit.edu/2.998/www/QuaternionReport1.pdf>

**Introduced in R2016a**

# quatinterp

Quaternion interpolation between two quaternions

## Syntax

```
qi=quatinterp(p,q,f,method)
```

## Description

`qi=quatinterp(p,q,f,method)` calculates the quaternion interpolation between two normalized quaternions `p` and `q` by interval fraction `f`.

`p` and `q` are the two extremes between which the function calculates the quaternion.

## Examples

### Quaternion Interpolation Between Two Quaternions

Use interpolation to calculate quaternion between two quaternions `p=[1.0 0 1.0 0]` and `q=[-1.0 0 1.0 0]` using the SLERP method. This example uses the `quatnormalize` function to first-normalize the two quaternions to `pn` and `qn`.

```
pn = quatnormalize([1.0 0 1.0 0])
qn = quatnormalize([-1.0 0 1.0 0])
qi = quatinterp(pn,qn,0.5,'slerp')
```

```
pn =
```

```
    0.7071         0    0.7071         0
```

```
qn =
```

```
   -0.7071         0    0.7071         0
```

```
qi =
```

0 0 1 0

## Input Arguments

### **p** — First-normalized quaternion

*M*-by-4 matrix

First normalized quaternion for which to calculate the interpolation, specified as an *M*-by-4 matrix containing *M* quaternions. This quaternion must be a normalized quaternion.

Data Types: double

### **q** — Quaternions

*M*-by-4 matrix

Second normalized quaternion for which to calculate the interpolation, specified as an *M*-by-4 matrix containing *M* quaternions. This quaternion must be a normalized quaternion.

Data Types: double

### **f** — Interval fraction

*M*-by-1 matrix

Interval fraction by which to calculate the quaternion interpolation, specified as an *M*-by-1 matrix containing *M* fractions (scalar). *f* varies between 0 and 1. It represents the intermediate rotation of the quaternion to be calculated.

 $q_i=(q_p, q_n, q_f)$ , where:

- If *f* equals 0,  $q_i$  equals  $q_p$ .
- If *f* is between 0 and 1,  $q_i$  equals *method*.
- If *f* equals 1,  $q_i$  equals  $q_n$ .

Data Types: double

### **method** — Quaternion interpolation method

'slerp' (default) | 'lerp' | 'nlerp'

Quaternion interpolation method to calculate the quaternion interpolation. These methods have different rotational velocities, depending on the interval fraction.

For more information on interval fractions, see <http://web.mit.edu/2.998/www/QuaternionReport1.pdf>.

- `slerp`

Quaternion `slerp`. Spherical linear quaternion interpolation method. This method is most accurate, but also most computation intense.

$$\text{Slerp}(p, q, h) = p(p^* q)^h \text{ with } h \in [0, 1].$$

- `lerp`

Quaternion `lerp`. Linear quaternion interpolation method. This method is the quickest, but is also least accurate. The method does not always generate normalized output.

$$\text{LERP}(p, q, h) = p(1 - h) + qh \text{ with } h \in [0, 1].$$

- `nlerp`

Normalized quaternion linear interpolation method.

$$\text{With } r = \text{LERP}(p, q, h), \text{ NLERP}(p, q, h) = \frac{r}{|r|}.$$

Data Types: char

## Output Arguments

### **qi** — Interpolation of quaternion

*M*-by-4 matrix

Interpolation of quaternion.

## See Also

### See Also

`quatconj` | `quatdivide` | `quatexp` | `quatinv` | `quatlog` | `quatmod` | `quatmultiply` | `quatnormalize` | `quatpower` | `quatrotate`

**External Websites**

<http://web.mit.edu/2.998/www/QuaternionReport1.pdf>

**Introduced in R2016a**

## quatinv

Calculate inverse of quaternion

### Syntax

`n = quatinv(q)`

### Description

`n = quatinv(q)` calculates the inverse, `n`, for a given quaternion, `q`. Input `q` is an `m`-by-4 matrix containing `m` quaternions. `n` returns an `m`-by-4 matrix of inverses. Each element of `q` must be a real number. Additionally, `q` has its scalar number as the first column.

The quaternion has the form of

$$q = q_0 + \mathbf{i}q_1 + \mathbf{j}q_2 + \mathbf{k}q_3$$

The quaternion inverse has the form of

$$q^{-1} = \frac{q_0 - \mathbf{i}q_1 - \mathbf{j}q_2 - \mathbf{k}q_3}{q_0^2 + q_1^2 + q_2^2 + q_3^2}$$

### Examples

Determine the inverse of `q = [1 0 1 0]`:

```
qinv = quatinv([1 0 1 0])
```

```
qinv =
```

```
    0.5000         0   -0.5000         0
```

### References

- [1] Stevens, Brian L., Frank L. Lewis, *Aircraft Control and Simulation*, Wiley–Interscience, 2nd Edition.

## Extended Capabilities

### C/C++ Code Generation

Generate C and C++ code using MATLAB® Coder™.

Usage notes and limitations:

Code generation for this function requires the Aerospace Blockset software.

### See Also

`quatconj` | `quatdivide` | `quatmod` | `quatmultiply` | `quatnorm` | `quatnormalize`  
| `quatrotate`

**Introduced in R2006b**



## quatlog

Natural logarithm of quaternion

### Syntax

```
q1=quatlog(q)
```

### Description

`q1=quatlog(q)` calculates the natural logarithm, `q1`, for a normalized quaternion, `q`.

This function uses the relationships.

For  $q = [\cos(\theta), \sin(\theta)v]$ , with  $\log(q) = [0, \theta v]$ .

### Examples

#### Calculate the Natural Logarithm of Quaternion

Calculate the natural logarithm of quaternion matrix `q=[1.0 0 1.0 0]`.

```
qlog = quatlog(quatnormalize([1.0 0 1.0 0]))
```

```
qlog =
```

```
0         0     0.7854     0
```

### Input Arguments

#### **q** — Quaternions

*M*-by-4 matrix

Quaternions for which to calculate the natural logarithm, specified as an *M*-by-4 matrix containing *M* quaternions. This quaternion must be a normalized quaternion.

Data Types: double

### Output Arguments

**q1** — Natural logarithm of quaternion

*M*-by-4 matrix

Natural logarithm of quaternion.

### See Also

#### See Also

`quatconj` | `quatdivide` | `quatexp` | `quatinterp` | `quatinv` | `quatmod` | `quatmultiply` | `quatnormalize` | `quatpower` | `quatrotate`

#### External Websites

<http://web.mit.edu/2.998/www/QuaternionReport1.pdf>

**Introduced in R2016a**

## quatmod

Calculate modulus of quaternion

### Syntax

```
n = quatmod(q)
```

### Description

`n = quatmod(q)` calculates the modulus, `n`, for a given quaternion, `q`. Input `q` is an `m`-by-4 matrix containing `m` quaternions. `n` returns a column vector of `m` moduli. Each element of `q` must be a real number. Additionally, `q` has its scalar number as the first column.

The quaternion has the form of

$$q = q_0 + \mathbf{i}q_1 + \mathbf{j}q_2 + \mathbf{k}q_3$$

The quaternion modulus has the form of

$$|q| = \sqrt{q_0^2 + q_1^2 + q_2^2 + q_3^2}$$

### Examples

Determine the modulus of `q = [1 0 0 0]`:

```
mod = quatmod([1 0 0 0])
```

```
mod =
```

```
1
```

### References

- [1] Stevens, Brian L., Frank L. Lewis, *Aircraft Control and Simulation*, Wiley–Interscience, 2nd Edition.

## Extended Capabilities

### C/C++ Code Generation

Generate C and C++ code using MATLAB® Coder™.

Usage notes and limitations:

Code generation for this function requires the Aerospace Blockset software.

### See Also

`quatconj` | `quatdivide` | `quatinv` | `quatmultiply` | `quatnorm` | `quatnormalize`  
| `quatrotate`

**Introduced in R2006b**

# quatmultiply

Calculate product of two quaternions

## Syntax

$n = \text{quatmultiply}(q, r)$

## Description

$n = \text{quatmultiply}(q, r)$  calculates the quaternion product,  $n$ , for two given quaternions,  $q$  and  $r$ . Inputs  $q$  and  $r$  can each be either an  $m$ -by-4 matrix containing  $m$  quaternions, or a single 1-by-4 quaternion.  $n$  returns an  $m$ -by-4 matrix of quaternion products. Each element of  $q$  and  $r$  must be a real number. Additionally,  $q$  and  $r$  have their scalar number as the first column.

The quaternions have the form of

$$q = q_0 + \mathbf{i}q_1 + \mathbf{j}q_2 + \mathbf{k}q_3$$

and

$$r = r_0 + \mathbf{i}r_1 + \mathbf{j}r_2 + \mathbf{k}r_3$$

The quaternion product has the form of

$$n = q \times r = n_0 + \mathbf{i}n_1 + \mathbf{j}n_2 + \mathbf{k}n_3$$

where

$$n_0 = (r_0q_0 - r_1q_1 - r_2q_2 - r_3q_3)$$

$$n_1 = (r_0q_1 + r_1q_0 - r_2q_3 + r_3q_2)$$

$$n_2 = (r_0q_2 + r_1q_3 + r_2q_0 - r_3q_1)$$

$$n_3 = (r_0q_3 - r_1q_2 + r_2q_1 + r_3q_0)$$

---

**Note** Quaternion multiplication is not commutative.

---

### Examples

Determine the product of two 1-by-4 quaternions:

```
q = [1 0 1 0];  
r = [1 0.5 0.5 0.75];  
mult = quatmultiply(q, r)
```

```
mult =
```

```
    0.5000    1.2500    1.5000    0.2500
```

Determine the product of a 1-by-4 quaternion with itself:

```
q = [1 0 1 0];  
mult = quatmultiply(q)
```

```
mult =
```

```
    0    0    2    0
```

Determine the product of 1-by-4 and 2-by-4 quaternions:

```
q = [1 0 1 0];  
r = [1 0.5 0.5 0.75; 2 1 0.1 0.1];  
mult = quatmultiply(q, r)
```

```
mult =
```

```
    0.5000    1.2500    1.5000    0.2500  
    1.9000    1.1000    2.1000   -0.9000
```

### References

- [1] Stevens, Brian L., Frank L. Lewis, *Aircraft Control and Simulation*, Wiley-Interscience, 2nd Edition.

## Extended Capabilities

### C/C++ Code Generation

Generate C and C++ code using MATLAB® Coder™.

Usage notes and limitations:

Code generation for this function requires the Aerospace Blockset software.

### See Also

quatconj | quatdivide | quatinv | quatmod | quatnorm | quatnormalize | quatrotate

**Introduced in R2006b**

## quatnorm

Calculate norm of quaternion

### Syntax

`n = quatnorm(q)`

### Description

`n = quatnorm(q)` calculates the norm,  $n$ , for a given quaternion,  $q$ . Input  $q$  is an  $m$ -by-4 matrix containing  $m$  quaternions.  $n$  returns a column vector of  $m$  norms. Each element of  $q$  must be a real number. Additionally,  $q$  has its scalar number as the first column.

The quaternion has the form of

$$q = q_0 + \mathbf{i}q_1 + \mathbf{j}q_2 + \mathbf{k}q_3$$

The quaternion norm has the form of

$$\text{norm}(q) = q_0^2 + q_1^2 + q_2^2 + q_3^2$$

### Examples

Determine the norm of  $q = [1 \ 0 \ 0 \ 0]$ :

```
norm=quatnorm([.5 -.5 .5 0])
```

```
norm =
```

```
0.7500
```

### References

- [1] Stevens, Brian L., Frank L. Lewis, *Aircraft Control and Simulation*, Wiley–Interscience, 2nd Edition.



## Extended Capabilities

### C/C++ Code Generation

Generate C and C++ code using MATLAB® Coder™.

Usage notes and limitations:

Code generation for this function requires the Aerospace Blockset software.

### See Also

`quatconj` | `quatdivide` | `quatinv` | `quatmod` | `quatmultiply` | `quatnormalize` | `quatrotate`

**Introduced in R2006b**

## quatnormalize

Normalize quaternion

### Syntax

```
n = quatnormalize(q)
```

### Description

`n = quatnormalize(q)` calculates the normalized quaternion, `n`, for a given quaternion, `q`. Input `q` is an `m`-by-4 matrix containing `m` quaternions. `n` returns an `m`-by-4 matrix of normalized quaternions. Each element of `q` must be a real number. Additionally, `q` has its scalar number as the first column.

The quaternion has the form of

$$q = q_0 + \mathbf{i}q_1 + \mathbf{j}q_2 + \mathbf{k}q_3$$

The normalized quaternion has the form of

$$\mathit{normal}(q) = \frac{q_0 + \mathbf{i}q_1 + \mathbf{j}q_2 + \mathbf{k}q_3}{\sqrt{q_0^2 + q_1^2 + q_2^2 + q_3^2}}$$

### Examples

Normalize `q = [1 0 1 0]`:

```
normal = quatnormalize([1 0 1 0])
```

```
normal =
```

```
0.7071      0      0.7071      0
```

## References

- [1] Stevens, Brian L., Frank L. Lewis, *Aircraft Control and Simulation*, Wiley–Interscience, 2nd Edition.

## Extended Capabilities

### C/C++ Code Generation

Generate C and C++ code using MATLAB® Coder™.

Usage notes and limitations:

Code generation for this function requires the Aerospace Blockset software.

### See Also

quatconj | quatdivide | quatinv | quatmod | quatmultiply | quaternorm | quatrotate

**Introduced in R2006b**

## quatpower

Power of quaternion

### Syntax

```
qp=quatpower(q,pow)
```

### Description

`qp=quatpower(q,pow)` calculates  $q$  to the power of `pow` for a normalized quaternion,  $q$ .

$$q^t = \exp(t \cdot \log(q)), \text{ with } t \in \mathbb{R}.$$

### Examples

#### Calculate the Power of Quaternion

Calculate the power of 2 of quaternion  $q = [1.0 \ 0 \ 1.0 \ 0]$ .

```
qp = quatpower(quatnormalize([1.0 0 1.0 0]),2)
```

```
qp =
```

```
    -0.0000         0    1.0000         0
```

### Input Arguments

#### **q** — Quaternions

$M$ -by-4 matrix

Quaternions for which to calculate exponentials, specified as an  $M$ -by-4 matrix containing  $M$  quaternions.

Data Types: double

**pow — Power***M*-by-1 vector

Power to which to calculate quaternion power, specified as an *M*-by-1 vector containing *M* power scalars.

Data Types: double

## Output Arguments

**qp — Power of quaternion***M*-by-4 matrix

Power of quaternion.

## See Also

**See Also**

quatconj | quatdivide | quatexp | quatinterp | quatinv | quatlog | quatmod  
| quatmultiply | quatnormalize | quatrotate

**External Websites**

<http://web.mit.edu/2.998/www/QuaternionReport1.pdf>

Introduced in R2016a

## quatrotate

Rotate vector by quaternion

### Syntax

$n = \text{quatrotate}(q, r)$

### Description

$n = \text{quatrotate}(q, r)$  calculates the rotated vector,  $n$ , for a quaternion,  $q$ , and a vector,  $r$ .  $q$  is either an  $m$ -by-4 matrix containing  $m$  quaternions, or a single 1-by-4 quaternion.  $r$  is either an  $m$ -by-3 matrix, or a single 1-by-3 vector.  $n$  returns an  $m$ -by-3 matrix of rotated vectors. Each element of  $q$  and  $r$  must be a real number. Additionally,  $q$  has its scalar number as the first column.

The quaternion has the form of

$$q = q_0 + \mathbf{i}q_1 + \mathbf{j}q_2 + \mathbf{k}q_3$$

The vector has the form of

$$v = \mathbf{i}v_1 + \mathbf{j}v_2 + \mathbf{k}v_3$$

The rotated vector has the form of

$$v' = \begin{bmatrix} v_1' \\ v_2' \\ v_3' \end{bmatrix} = \begin{bmatrix} (1 - 2q_2^2 - 2q_3^2) & 2(q_1q_2 + q_0q_3) & 2(q_1q_3 - q_0q_2) \\ 2(q_1q_2 - q_0q_3) & (1 - 2q_1^2 - 2q_3^2) & 2(q_2q_3 + q_0q_1) \\ 2(q_1q_3 + q_0q_2) & 2(q_2q_3 - q_0q_1) & (1 - 2q_1^2 - 2q_2^2) \end{bmatrix} \begin{bmatrix} v_1 \\ v_2 \\ v_3 \end{bmatrix}$$

For more information, see [Representing Attitude: Euler Angles, Unit Quaternions, and Rotation Vectors](#).

## Examples

Rotate a 1-by-3 vector by a 1-by-4 quaternion:

```
q = [1 0 1 0];
r = [1 1 1];
n = quatrotate(q, r)
```

n =

```
-1.0000    1.0000    1.0000
```

Rotate a 1-by-3 vector by a 2-by-4 quaternion:

```
q = [1 0 1 0; 1 0.5 0.3 0.1];
r = [1 1 1];
n = quatrotate(q, r)
```

n =

```
-1.0000    1.0000    1.0000
 0.8519    1.4741    0.3185
```

Rotate a 2-by-3 vector by a 1-by-4 quaternion:

```
q = [1 0 1 0];
r = [1 1 1; 2 3 4];
n = quatrotate(q, r)
```

n =

```
-1.0000    1.0000    1.0000
-4.0000    3.0000    2.0000
```

Rotate a 2-by-3 vector by a 2-by-4 quaternion:

```
q = [1 0 1 0; 1 0.5 0.3 0.1];
r = [1 1 1; 2 3 4];
n = quatrotate(q, r)
```

n =

-1.0000	1.0000	1.0000
1.3333	5.1333	0.9333

### References

- [1] Stevens, Brian L., Frank L. Lewis, *Aircraft Control and Simulation*, Wiley–Interscience, 2nd Edition.
- [2] Representing Attitude: Euler Angles, Unit Quaternions, and Rotation Vectors

### See Also

`quatconj` | `quatinv` | `quatmod` | `quatmultiply` | `quatnorm` | `quatnormalize`

**Introduced in R2006b**



## read (Aero.Geometry)

Read geometry data using current reader

### Syntax

```
read(h, source)
```

### Description

`read(h, source)` reads the geometry data of the geometry object `h`. `source` can be:

- 'Auto'

Selects default reader.

- 'Variable'

Selects MATLAB variable of type structure structures that contains the `fieldname`, `faces`, `vertices`, and `cdata` that define the geometry in the Handle Graphics patches.

- 'MatFile'

Selects MAT-file reader.

- 'Ac3dFile'

Selects Ac3d file reader.

- 'Custom'

Selects a custom reader.

### Examples

Read geometry data from Ac3d file, `pa24-250_orange.ac`.

```
g = Aero.Geometry;  
g.Source = 'Ac3d';
```

```
g.read('pa24-250_orange.ac');
```

**Introduced in R2007a**

# removeBody

**Class:** Aero.Animation

**Package:** Aero

Remove one body from animation

## Syntax

```
h = removeBody(h,idx)
h = h.removeBody(idx)
```

## Description

`h = removeBody(h,idx)` and `h = h.removeBody(idx)` remove the body specified by the index `idx` from the animation object `h`.

## Input Arguments

<code>h</code>	Animation object.
<code>idx</code>	Body specified with this index.

## Examples

Remove the body identified by the index, 1.

```
h = Aero.Animation;
idx1 = h.createBody('pa24-250_orange.ac','Ac3d');
h = removeBody(h,1)
```

## removeNode (Aero.VirtualRealityAnimation)

Remove node from virtual reality animation object

### Syntax

```
removeNode(h,node)
h.removeNode(node)
```

### Description

`removeNode(h,node)` and `h.removeNode(node)` remove the node specified by `node` from the virtual reality animation object `h`. `node` can be either the node name or the node index. This function can remove only one node at a time.

---

**Note:** You can use only this function to remove a node added by `addNode`. If you need to remove a node from a previously defined `.wrl` file, use a VRML editor.

---

### Examples

Remove the node, Lynx1.

```
h = Aero.VirtualRealityAnimation;
h.VRWorldFilename = [matlabroot,'/toolbox/aero/astdemos/asttkoff.wrl'];
copyfile(h.VRWorldFilename,[tempdir,'asttkoff.wrl'],'f');
h.VRWorldFilename = [tempdir,'asttkoff.wrl'];
h.initialize();
h.addNode('Lynx1',[matlabroot,'/toolbox/aero/astdemos/chaseHelicopter.wrl']);
h.removeNode('Lynx1');
```

### See Also

`addNode`

Introduced in R2007b

# removeViewpoint (Aero.VirtualRealityAnimation)

Remove viewpoint node from virtual reality animation

## Syntax

```
removeViewpoint(h,viewpoint)
h.removeViewpoint(viewpoint)
```

## Description

`removeViewpoint(h,viewpoint)` and `h.removeViewpoint(viewpoint)` remove the viewpoint specified by `viewpoint` from the virtual reality animation object `h`. `viewpoint` can be either the viewpoint name or the viewpoint index. This function can remove only one viewpoint at a time.

---

**Note:** You can use this function to remove a viewpoint added by `addViewpoint`. If you need to remove a viewpoint from a previously defined `.wrl` file, use a VRML editor.

---

## Examples

Remove the node, Lynx1.

```
h = Aero.VirtualRealityAnimation;
h.VRWorldFilename = [matlabroot,'/toolbox/aero/astdemos/asttkoff.wrl'];
copyfile(h.VRWorldFilename,[tempdir,'asttkoff.wrl'],'f');
h.VRWorldFilename = [tempdir,'asttkoff.wrl'];
h.initialize();
h.addViewpoint(h.Nodes{2}.VRNode,'children','chaseView','View From Helicopter');
h.removeViewpoint('chaseView');
```

## See Also

`addViewpoint`

Introduced in R2007b

## rod2angle

Convert Euler-Rodrigues vector to rotation angles

### Syntax

```
[R1 R2 R3]=rod2angle(rod)
[R1 R2 R3]=rod2angle(rod,S)
```

### Description

`[R1 R2 R3]=rod2angle(rod)` function calculates the set of rotation angles, R1, R2, and R3, for a given Euler-Rodrigues (also known as Rodrigues) vector, `rod`.

`[R1 R2 R3]=rod2angle(rod,S)` function calculates the set of rotation angles for a given Rodrigues vector and a specified rotation sequence, `S`.

### Examples

#### Determine Rotation Angles from One Vector

Determine rotation angles from vector, `[.1 .2 -.1]`.

```
r = [.1 .2 -.1];
[yaw, pitch, roll] = rod2angle(r)
```

```
yaw =
```

```
    -0.1651
```

```
pitch =
```

```
    0.4074
```

```
roll =
```

0.1651

## Input Arguments

### **rod** — Rodrigues vector

*M*-by-3 matrix*M*-by-3 matrix containing *M* Rodrigues vector.

Data Types: double

### **S** — Rotation sequence

ZYX (default) | ZYZ | ZXY | ZXZ | YXZ | YXY | YZX | YZY | XYZ | XYX | XZY | XZX

Rotation angles, in radians, from which to determine Rodrigues vector. For the default rotation sequence, ZYX, the rotation angle order is:

- R1 — *z*-axis rotation
- R2 — *y*-axis rotation
- R3 — *x*-axis rotation

Data Types: double

## Output Arguments

### **R1** — First rotation angles

*M*-by-1 array*M*-by-1 array of first rotation angles, in radians.

### **R2** — Second rotation angles

*M*-by-1 array*M*-by-1 array of second rotation angles, in radians.

### **R3** — Third rotation angles

*M*-by-1 array*M*-by-1 array of third rotation angles, in radians.

## Algorithms

An Euler-Rodrigues vector  $\vec{b}$  represents a rotation by integrating a direction cosine of a rotation axis with the tangent of half the rotation angle as follows:

$$\vec{b} = [b_x \quad b_y \quad b_z]$$

where:

$$b_x = \tan\left(\frac{1}{2}\theta\right)s_x,$$

$$b_y = \tan\left(\frac{1}{2}\theta\right)s_y,$$

$$b_z = \tan\left(\frac{1}{2}\theta\right)s_z$$

are the Rodrigues parameters. Vector  $\vec{s}$  represents a unit vector around which the rotation is performed. Due to the tangent, the rotation vector is indeterminate when the rotation angle equals  $\pm\pi$  radians or  $\pm 180$  deg. Values can be negative or positive.

## References

- [1] Dai, J.S. "Euler-Rodrigues formula variations, quaternion conjugation and intrinsic connections." *Mechanism and Machine Theory*, 92, 144-152. Elsevier, 2015.

## See Also

### See Also

`angle2rod` | `dcm2rod` | `quat2rod` | `rod2dcm` | `rod2quat`

**Introduced in R2017a**



# rod2dcm

Convert Euler-Rodrigues vector to direction cosine matrix

## Syntax

```
dcm=rod2dcm(R)
```

## Description

`dcm=rod2dcm(R)` function calculates the direction cosine matrix, for a given Euler-Rodrigues (also known as Rodrigues) vector, *R*.

## Examples

### Determine Direction Cosine Matrix from Euler-Rodrigues Vector

Determine the direction cosine matrix from the Euler-Rodrigues vector.

```
r = [.1 .2 -.1];  
DCM = rod2dcm(r)
```

```
DCM =
```

```
    0.9057    -0.1509   -0.3962  
    0.2264     0.9623     0.1509  
    0.3585   -0.2264     0.9057
```

## Input Arguments

### **R** — Rodrigues vector

*M*-by-3 matrix

*M*-by-3 matrix containing *M* Rodrigues vectors.

Data Types: double

## Output Arguments

**dcm** — Direction cosine matrix

3-by-3-by- $M$  matrix

3-by-3-by- $M$  containing  $M$  direction cosine matrices.

## Algorithms

An Euler-Rodrigues vector  $\bar{b}$  represents a rotation by integrating a direction cosine of a rotation axis with the tangent of half the rotation angle as follows:

$$\bar{b} = [b_x \quad b_y \quad b_z]$$

where:

$$b_x = \tan\left(\frac{1}{2}\theta\right)s_x,$$

$$b_y = \tan\left(\frac{1}{2}\theta\right)s_y,$$

$$b_z = \tan\left(\frac{1}{2}\theta\right)s_z$$

are the Rodrigues parameters. Vector  $\bar{s}$  represents a unit vector around which the rotation is performed. Due to the tangent, the rotation vector is indeterminate when the rotation angle equals  $\pm\pi$  radians or  $\pm 180$  deg. Values can be negative or positive.

## References

- [1] Dai, J.S. "Euler-Rodrigues formula variations, quaternion conjugation and intrinsic connections." *Mechanism and Machine Theory*, 92, 144-152. Elsevier, 2015.

## See Also

### See Also

`angle2rod` | `dcm2rod` | `quat2rod` | `rod2angle` | `rod2quat`

**Introduced in R2017a**

## rod2quat

Convert Euler-Rodrigues vector to quaternion

### Syntax

```
quat=rod2quat(R)
```

### Description

quat=rod2quat(R) function calculates the quaternion, quat, for a given Euler-Rodrigues (also known as Rodrigues) vector, R.

### Examples

#### Determine Quaternion from Rodrigues Vector

Determine the quaternion from Rodrigues vector.

```
r = [.1 .2 -.1];  
q = rod2quat(r)
```

```
q =
```

```
    0.9713    0.0971    0.1943   -0.0971
```

### Input Arguments

#### **R** — Rodrigues vector

*M*-by-1 matrix

*M*-by-1 array of Rodrigues vectors.

Data Types: double

## Output Arguments

### quat — Rodrigues vector

*M*-by-4 matrix

*M*-by-4 matrix of *M* quaternions. `quat` has its scalar number as the first column.

## Algorithms

An Euler-Rodrigues vector  $\vec{b}$  represents a rotation by integrating a direction cosine of a rotation axis with the tangent of half the rotation angle as follows:

$$\vec{b} = [b_x \quad b_y \quad b_z]$$

where:

$$b_x = \tan\left(\frac{1}{2}\theta\right)s_x,$$

$$b_y = \tan\left(\frac{1}{2}\theta\right)s_y,$$

$$b_z = \tan\left(\frac{1}{2}\theta\right)s_z$$

are the Rodrigues parameters. Vector  $\vec{s}$  represents a unit vector around which the rotation is performed. Due to the tangent, the rotation vector is indeterminate when the rotation angle equals  $\pm\pi$  radians or  $\pm 180$  deg. Values can be negative or positive.

## References

- [1] Dai, J.S. "Euler-Rodrigues formula variations, quaternion conjugation and intrinsic connections." *Mechanism and Machine Theory*, 92, 144-152. Elsevier, 2015.

## **See Also**

### **See Also**

`angle2rod` | `dcm2rod` | `quat2rod` | `rod2angle` | `rod2dcm`

**Introduced in R2017a**

## rrdelta

Compute relative pressure ratio

### Syntax

```
d = rrdelta(p0, mach, g)
```

### Description

`d = rrdelta(p0, mach, g)` computes `m` pressure relative ratios, `d`, from `m` static pressures, `p0`, `m` Mach numbers, `mach`, and `m` specific heat ratios, `g`. `p0` must be in pascals.

### Examples

Determine the relative pressure ratio for three pressures:

```
delta = rrdelta([101325 22632.0672 4328.1393], 0.5, 1.4)
```

```
delta =
```

```
    1.1862    0.2650    0.0507
```

Determine the relative pressure ratio for three pressures and three different heat ratios:

```
delta = rrdelta([101325 22632.0672 4328.1393], 0.5, [1.4 1.35 1.4])
```

```
delta =
```

```
    1.1862    0.2635    0.0507
```

Determine the relative pressure ratio for three pressures at three different conditions:

```
delta = rrdelta([101325 22632.0672 4328.1393], [0.5 1 2], [1.4 1.35 1.4])
```

```
delta =
```

1.1862    0.4161    0.3342

### Assumptions and Limitations

For cases in which total pressure ratio is desired (Mach number is nonzero), the total pressures are calculated assuming perfect gas (with constant molecular weight, constant pressure specific heat, and constant specific heat ratio) and dry air.

### References

*Aeronautical Vestpocket Handbook*, United Technologies Pratt & Whitney, August, 1986

### See Also

rrsigma | rrtheta

Introduced in R2006b



## rrsigma

Compute relative density ratio

### Syntax

```
s = rrsigma(rho, mach, g)
```

### Description

`s = rrsigma(rho, mach, g)` computes  $m$  density relative ratios, `s`, from  $m$  static densities, `rho`,  $m$  Mach numbers, `mach`, and  $m$  specific heat ratios, `g`. `rho` must be in kilograms per meter cubed.

### Examples

Determine the relative density ratio for three densities:

```
sigma = rrsigma([1.225 0.3639 0.0953], 0.5, 1.4)
```

```
sigma =
```

```
    1.1297    0.3356    0.0879
```

Determine the relative density ratio for three densities and three different heat ratios:

```
sigma = rrsigma([1.225 0.3639 0.0953], 0.5, [1.4 1.35 1.4])
```

```
sigma =
```

```
    1.1297    0.3357    0.0879
```

Determine the relative density ratio for three densities at three different conditions:

```
sigma = rrsigma([1.225 0.3639 0.0953], [0.5 1 2], [1.4 1.35 1.4])
```

sigma =

1.1297    0.4709    0.3382

## Assumptions and Limitations

For cases in which total density ratio is desired (Mach number is nonzero), the total density is calculated assuming perfect gas (with constant molecular weight, constant pressure specific heat, and constant specific heat ratio) and dry air.

## References

*Aeronautical Vestpocket Handbook*, United Technologies Pratt & Whitney, August, 1986

## See Also

rrdelta | rrtheta

Introduced in R2006b

## rrtheta

Compute relative temperature ratio

### Syntax

```
th = rrtheta(t0, mach, g)
```

### Description

`th = rrtheta(t0, mach, g)` computes  $m$  temperature relative ratios, `th`, from  $m$  static temperatures, `t0`,  $m$  Mach numbers, `mach`, and  $m$  specific heat ratios, `g`. `t0` must be in kelvin.

### Examples

Determine the relative temperature ratio for three temperatures:

```
th = rrtheta([273.15 310.9278 373.15], 0.5, 1.4)
```

```
th =
```

```
    0.9953    1.1330    1.3597
```

Determine the relative temperature ratio for three temperatures and three different heat ratios:

```
th = rrtheta([273.15 310.9278 373.15], 0.5, [1.4 1.35 1.4])
```

```
th =
```

```
    0.9953    1.1263    1.3597
```

Determine the relative temperature ratio for three temperatures at three different conditions:

```
th = rrtheta([273.15 310.9278 373.15], [0.5 1 2], [1.4 1.35 1.4])
```

th =

0.9953    1.2679    2.3310

## Assumptions and Limitations

For cases in which total temperature ratio is desired (Mach number is nonzero), the total temperature is calculated assuming perfect gas (with constant molecular weight, constant pressure specific heat, and constant specific heat ratio) and dry air.

## References

*Aeronautical Vestpocket Handbook*, United Technologies Pratt & Whitney, August, 1986

## See Also

rrdelta | rrsigma

Introduced in R2006b

## saveas (Aero.VirtualRealityAnimation)

Save virtual reality world associated with virtual reality animation object

### Syntax

```
saveas(h, filename)
h.saveas(filename)
saveas(h, filename, '-nothumbnail')
h.saveas(filename, '-nothumbnail')
```

### Description

`saveas(h, filename)` and `h.saveas(filename)` save the world associated with the virtual reality animation object, `h`, into the `.wrl` file name specified in the `filename` variable. After saving, this function reinitializes the virtual reality animation object from the saved world.

`saveas(h, filename, '-nothumbnail')` and `h.saveas(filename, '-nothumbnail')` suppress creating a thumbnail image used for virtual world preview.

### Examples

Save the world associated with `h`.

```
h = Aero.VirtualRealityAnimation;
h.VRWorldFilename = [matlabroot, '/toolbox/aero/astdemos/asttkoff.wrl'];
copyfile(h.VRWorldFilename, [tempdir, 'asttkoff.wrl'], 'f');
h.VRWorldFilename = [tempdir, 'asttkoff.wrl'];
h.initialize();
h.saveas([tempdir, 'my_asttkoff.wrl']);
```

**Introduced in R2007b**

## SetTimer (Aero.FlightGearAnimation)

Set name of timer for animation of FlightGear flight simulator

### Syntax

```
SetTimer(h)  
h.SetTimer  
SetTimer(h, MyFGTimer)  
h.SetTimer('MyFGTimer')
```

### Description

`SetTimer(h)` and `h.SetTimer` set the name of the MATLAB timer for the animation of the FlightGear flight simulator. `SetTimer(h, MyFGTimer)` and `h.SetTimer('MyFGTimer')` set the name of the MATLAB timer for the animation of the FlightGear flight simulator and assign a custom name to the timer.

You can use this function to customize your FlightGear animation object. This customization allows you to simultaneously run multiple FlightGear objects if you want to use

- Multiple FlightGear sessions
- Different ports to connect to those sessions

### Examples

Set the MATLAB timer for animation of the FlightGear animation object, `h`:

```
h = Aero.FlightGearAnimation  
h.SetTimer
```

Set the MATLAB timer used for animation of the FlightGear animation object, `h`, and assign a custom name, `MyFGTimer`, to the timer:

```
h = Aero.FlightGearAnimation  
h.SetTimer('MyFGTimer')
```

## See Also

ClearTimer

Introduced in R2008b

# show

**Class:** Aero.Animation

**Package:** Aero

Show animation object figure

## Syntax

```
show(h)  
h.show
```

## Description

`show(h)` and `h.show` create the figure graphics object for the animation object `h`. Use the `Aero.Animation.hide` function to close the figure.

## Input Arguments

`h`                      Animation object.

## Examples

Show the animation object, `h`.

```
h = Aero.Animation;  
idx1 = h.createBody('pa24-250_orange.ac', 'Ac3d');  
h.show;
```



# tdbjuliandate

Convert from Barycentric Dynamical Time Estimate to Julian date

## Syntax

```
jdtdb = tdbjuliandate(terrestrial_time)
[jdtdb,tttdb] = tdbjuliandate(terrestrial_time)
```

## Description

`jdtdb = tdbjuliandate(terrestrial_time)` returns an estimate of the Julian date for Barycentric Dynamical Time (TDB). These estimations are valid for the years 1980 to 2050.

`[jdtdb,tttdb] = tdbjuliandate(terrestrial_time)` additionally returns an array of Julian dates for the Barycentric Dynamical Time (TDB) based on the Terrestrial Time (TT).

## Examples

### Estimate Julian Date for Barycentric Dynamical Time

Estimate the Julian date for the Barycentric Dynamical Time for the Terrestrial Time 2014/10/15 16:22:31.

```
jdtdb = tdbjuliandate([2014,10,15,16,22,31])
jdtdb =
    2.4569e+06
```

### Estimate Julian Dates for the Barycentric Dynamical Time and TT-TDB

Estimate the Julian dates for the Barycentric Dynamical Time and TT-TDB in seconds for the terrestrial time 2014/10/15 16:22:31 and 2010/7/22 1:57:17.

```
[jdtdb,tttdb] = tdbjuliandate([2014,10,15,16,22,31;2010,7,22,1,57,17])
```

```
JDTDB =
```

```
1.0e+06 *  
2.4569  
2.4554
```

```
TTTTDB =
```

```
0.0016  
0.0005
```

## Input Arguments

### **terrestrial\_time** — Terrestrial Time

1-by-6 array |  $M$ -by-6 array

Terrestrial Time (TT) in year, month, day, hour, minutes, and seconds for which the function calculates the Julian date for Barycentric Dynamical Time.  $M$  is the number of Julian dates, one for each TT date. Specify values for year, month, day, hour, and minutes as whole numbers.

## Output Arguments

### **jdtdb** — Julian date

$M$ -by-1 array

Julian date for the Barycentric Dynamical Time, returned as an  $M$ -by-1 array.  $M$  is the number of rows, one for each Terrestrial Time input.

### **tttdb** — Difference in seconds

$M$ -by-1 array

Difference in seconds between Terrestrial Time and Barycentric Dynamical Time (TT-TDB), returned as an  $M$ -by-1 array.  $M$  is the number of rows, one for each Terrestrial Time input.

## Limitations

*Fundamentals of Astrodynamics and Applications*[1] indicates an accuracy of 50 microseconds, which this function cannot achieve due to numerical issues with the values involved.

## References

[1] Vallado, D. A., *Fundamentals of Astrodynamics and Applications*, New York: McGraw-Hill, 1997.

## See Also

### See Also

dcmecei2ecef | ecef211a | geoc2geod | geod2geoc | 11a2ecef | 11a2eci

**Introduced in R2015a**

# update (Aero.Body)

Change body position and orientation as function of time

## Syntax

```
update(h,t)
h.update(t)
```

## Description

`update(h,t)` and `h.update(t)` change body position and orientation of body `h` as a function of time `t`. `t` is a scalar in seconds.

---

**Note:** This function requires that you load the body geometry and time series data first.

---

## Examples

Update the body `b` with time in seconds of 5.

```
b=Aero.Body;
b.load('pa24-250_orange.ac','Ac3d');
tsdata = [ ...
    0, 1,1,1, 0,0,0; ...
    10 2,2,2, 1,1,1; ];
b.TimeSeriesSource = tsdata;
b.update(5);
```

## See Also

`load`

Introduced in R2007a

## update (Aero.Camera)

Update camera position based on time and position of other Aero.Body objects

### Syntax

```
update(h,newtime,bodies)  
h.update(newtime,bodies)
```

### Description

`update(h,newtime,bodies)` and `h.update(newtime,bodies)` update the camera object, `h`, position and aim point data based on the new time, `newtime`, and position of other Aero.Body objects, `bodies`. This function updates the camera object `PrevTime` property to `newtime`.

### See Also

`Aero.Animation.play`

**Introduced in R2007a**

## update (Aero.FlightGearAnimation)

Update position data to FlightGear animation object

### Syntax

```
update(h,time)
h.update(time)
```

### Description

`update(h,time)` and `h.update(time)` update the position data to the FlightGear animation object via UDP. It sets the new position and attitude of body `h`. `time` is a scalar in seconds.

---

**Note:** This function requires that you load the time series data and run FlightGear first.

---

### Examples

Configure a body with `TimeSeriesSource` set to `simdata`, then update the body with time `time` equal to 0.

```
h = Aero.FlightGearAnimation;
h.FramesPerSecond = 10;
h.TimeScaling = 5;
load simdata;
h.TimeSeriesSource = simdata;
t = 0;
h.update(t);
```

### See Also

`play` | `GenerateRunScript` | `initialize`

Introduced in R2007a

## update (Aero.Node)

Change node position and orientation versus time data

### Syntax

```
update(h,t)
h.update(t)
```

### Description

`update(h,t)` and `h.update(t)` change node position and orientation of node `h` as a function of time `t`. `t` is a scalar in seconds.

---

**Note:** This function requires that you load the node and time series data first.

---

### Examples

Move the Lynx body.

```
h = Aero.VirtualRealityAnimation;
h.FramesPerSecond = 10;
h.TimeScaling = 5;
h.VRWorldFilename = [matlabroot, '/toolbox/aero/astdemos/asttkoff.wrl'];
copyfile(h.VRWorldFilename,[tempdir, 'asttkoff.wrl'],'f');
h.VRWorldFilename = [tempdir, 'asttkoff.wrl'];
h.initialize();
load takeoffData
h.Nodes{7}.TimeseriesSource = takeoffData;
h.Nodes{7}.TimeseriesSourceType = 'StructureWithTime';
h.Nodes{7}.update(5);
```

### See Also

`updateNodes`

Introduced in R2007b

## updateBodies

**Class:** Aero.Animation

**Package:** Aero

Update bodies of animation object

### Syntax

```
h = updateBodies(time)
h.updateBodies(time)
```

### Description

`h = updateBodies(time)` and `h.updateBodies(time)` set the new position and attitude of movable bodies in the animation object `h`. This function updates the bodies contained in the animation object `h`. `time` is a scalar in seconds.

### Examples

Configure a body with `TimeSeriesSource` set to `simdata`, then update the body with time  $t$  equal to 0.

```
h = Aero.Animation;
h.FramesPerSecond = 10;
h.TimeScaling = 5;
idx1 = h.createBody('pa24-250_orange.ac', 'Ac3d');
load simdata;
h.Bodies{1}.TimeSeriesSource = simdata;
t = 0;
h.updateBodies(t);
```



# updateCamera

**Class:** Aero.Animation

**Package:** Aero

Update camera in animation object

## Syntax

```
updateCamera(h,time)
h.updateCamera(time)
```

## Description

`updateCamera(h,time)` and `h.updateCamera(time)` update the camera in the animation object `h`. `time` is a scalar in seconds.

---

**Note:** The `PositionFcn` property of a camera object controls the camera position relative to the bodies in the animation. The default camera `PositionFcn` follows the path of a first order chase vehicle. Therefore, it takes a few steps for the camera to position itself correctly in the chase plane position.

---

## Input Arguments

<code>h</code>	Animation object.
<code>time</code>	Scalar in seconds.

## Examples

Configure a body with `TimeSeriesSource` set to `simdata`, then update the camera with time `t` equal to 0.

```
h = Aero.Animation;
```

```
h.FramesPerSecond = 10;  
h.TimeScaling = 5;  
idx1 = h.createBody('pa24-250_orange.ac', 'Ac3d');  
load simdata;  
h.Bodies{1}.TimeSeriesSource = simdata;  
t = 0;  
h.updateCamera(t);
```

# updateNodes (Aero.VirtualRealityAnimation)

Change virtual reality animation node position and orientation as function of time

## Syntax

```
updateNodes(h,t)
h.updateNotes(t)
```

## Description

`updateNodes(h,t)` and `h.updateNotes(t)` change node position and orientation of body `h` as a function of time `t`. `t` is a scalar in seconds.

---

**Note:** This function requires that you load the node and time series data first.

---

## Examples

Update the node `h` with time in 5 seconds.

```
h = Aero.VirtualRealityAnimation;
h.FramesPerSecond = 10;
h.TimeScaling = 5;
h.VRWorldFilename = [matlabroot, '/toolbox/aero/astdemos/asttkoff.wrl'];
copyfile(h.VRWorldFilename,[tempdir,'asttkoff.wrl'],'f');
h.VRWorldFilename = [tempdir,'asttkoff.wrl'];
h.initialize();
load takeoffData
h.Nodes{7}.TimeseriesSource = takeoffData;
h.Nodes{7}.TimeseriesSourceType = 'StructureWithTime';
h.Nodes{7}.CoordTransformFcn = @vranimCustomTransform;
h.updateNodes(5);
```

## See Also

[update](#) | [addNode](#)

Introduced in R2007b

## **Viewpoint (Aero.Viewpoint)**

Create viewpoint object for use in virtual reality animation

### **Syntax**

```
h = Aero.Viewpoint
```

### **Description**

`h = Aero.Viewpoint` creates a viewpoint object for use with virtual reality animation.

See `Aero.Viewpoint` for further details.

**Introduced in R2007b**

# VirtualRealityAnimation (Aero.VirtualRealityAnimation)

Construct virtual reality animation object

## Syntax

```
h = Aero.VirtualRealityAnimation
```

## Description

`h = Aero.VirtualRealityAnimation` constructs a virtual reality animation object. The animation object is returned to `h`.

See `Aero.VirtualRealityAnimation` for further details.

## See Also

`Aero.VirtualRealityAnimation`

**Introduced in R2007b**

## wrldmagm

Use World Magnetic Model

---

**Note:** The '2000' or '2005' epoch year are outdated. For model years between 2000 and the start of 2010, use `igrfmagm`. For model years between 2010 and 2015, use `wrldmagm`.

---

### Syntax

```
[xyz, h, dec, dip, f] = wrldmagm(height, lat, lon, dyear)
[xyz, h, dec, dip, f] = wrldmagm(height, lat, lon, dyear, '2015')
[xyz, h, dec, dip, f] = wrldmagm(height, lat, lon, dyear, '2010')
[xyz, h, dec, dip, f] = wrldmagm(height, lat, lon, dyear, '2005')
[xyz, h, dec, dip, f] = wrldmagm(height, lat, lon, dyear, '2000')
```

### Description

`[xyz, h, dec, dip, f] = wrldmagm(height, lat, lon, dyear)` calculates the Earth's magnetic field at a specific location and time using the World Magnetic Model (WMM). The default WMM is WMM-2015, which is valid after the epoch of the model, which is January 1, 2015.

Inputs required by `wrldmagm` are:

<code>height</code>	A scalar value, in meters
<code>lat</code>	A scalar geodetic latitude, in degrees, where north latitude is positive, and south latitude is negative
<code>lon</code>	A scalar geodetic longitude, in degrees, where east longitude is positive, and west longitude is negative
<code>dyear</code>	A scalar decimal year. Decimal year is the desired year in a decimal format to include any fraction of the year that has already passed.

Outputs calculated for the Earth's magnetic field include:

xyz	Magnetic field vector in nanotesla (nT)
h	Horizontal intensity in nanotesla (nT)
dec	Declination in degrees
dip	Inclination in degrees
f	Total intensity in nanotesla (nT)

[xyz, h, dec, dip, f] = wrldmagm(height, lat, lon, dyear, '2015') is an alternate method for calling WMM-2015, or 2015 epoch.

[xyz, h, dec, dip, f] = wrldmagm(height, lat, lon, dyear, '2010') is an alternate method for calling WMM-2010, or 2010 epoch.

[xyz, h, dec, dip, f] = wrldmagm(height, lat, lon, dyear, '2005') is an alternate method for calling WMM-2005, or 2005 epoch.

[xyz, h, dec, dip, f] = wrldmagm(height, lat, lon, dyear, '2000') is the method for calling WMM-2000, or 2000 epoch.

## Examples

Calculate the magnetic model 1000 meters over Natick, Massachusetts on July 4, 2015, using WMM-2015:

```
[XYZ, H, DEC, DIP, F] = wrldmagm(1000, 42.283, -71.35, decyear(2015,7,4), '2015')
XYZ =
```

```
1.0e+04 *
    1.9454
   -0.5086
    4.8168
```

```
H =
```

```
2.0108e+04
```

```
DEC =
```

```
-14.6499
```

```
DIP =
```

67.3416

F =

5.2197e+04

## Assumptions and Limitations

The WMM specification produces data that is reliable five years after the epoch of the model, which begins January 1 of the model year selected. The WMM specification describes only the long-wavelength spatial magnetic fluctuations due to the Earth's core. Intermediate and short-wavelength fluctuations, contributed from the crustal field (the mantle and crust), are not included. Also, the substantial fluctuations of the geomagnetic field, which occur constantly during magnetic storms and almost constantly in the disturbance field (auroral zones), are not included.

## References

<http://www.ngdc.noaa.gov/geomag/WMM/DoDWMM.shtml>

“NOAA Technical Report: The US/UK World Magnetic Model for 2015–2020”

## See Also

decyear

Introduced in R2006b



## **Bodies property**

**Class:** Aero.Animation

**Package:** Aero

Specify name of animation object

### **Values**

MATLAB array

**Default:** [ ]

### **Description**

This property specifies the bodies that the animation object contains.

## Camera property

**Class:** Aero.Animation

**Package:** Aero

Specify camera that animation object contains

### Values

handle

**Default:** [ ]

### Description

This property specifies the camera that the animation object contains.

## Figure property

**Class:** Aero.Animation

**Package:** Aero

Specify name of figure object

### Values

MATLAB array

**Default:** [ ]

### Description

This property specifies the name of the figure object.

## FigureCustomizationFcn property

**Class:** Aero.Animation

**Package:** Aero

Specify figure customization function

### Values

MATLAB array

**Default:** [ ]

### Description

This property specifies the figure customization function.

## FramesPerSecond property

**Class:** Aero.Animation

**Package:** Aero

Animation rate

### Values

MATLAB array

**Default:** 12

### Description

This property specifies rate in frames per second.

## **Name property**

**Class:** Aero.Animation

**Package:** Aero

Specify name of animation object

## **Values**

Character vector

**Default:** ' '

## **Description**

This property specifies the name of the animation object.

## TCurrent property

**Class:** Aero.Animation

**Package:** Aero

Current time

### Values

double

**Default:** 0

### Description

This property specifies the current time.

## **TFinal property**

**Class:** Aero.Animation

**Package:** Aero

End time

### **Values**

double

**Default:** NaN

### **Description**

This property specifies the end time.



## TimeScaling property

**Class:** Aero.Animation

**Package:** Aero

Scaling time

### Values

double

**Default:** 1

### Description

This property specifies the time, in seconds.

## TStart property

**Class:** Aero.Animation

**Package:** Aero

Start time

### Values

double

**Default:** NaN

### Description

This property specifies the start time.

# VideoCompression property

**Class:** Aero.Animation

**Package:** Aero

Video recording compression file type

## Values

### **'Archival'**

Create Motion JPEG 2000 format file with lossless compression.

### **'Motion JPEG AVI'**

Create compressed AVI format file using Motion JPEG codec.

### **'Motion JPEG 2000'**

Create compressed Motion JPEG 2000 format file.

### **'MPEG-4'**

Create compressed MPEG-4 format file with H.264 encoding (Windows 7 systems only).

### **'Uncompressed AVI'**

Create uncompressed AVI format file with RGB24 video.

Data type: Aero.VideoProfileTypeEnum

Default: 'Archival'

## Description

This property specifies the compression file type to create. For more information on video compression, see VideoWriter.

## VideoFileName property

**Class:** Aero.Animation

**Package:** Aero

Video recording file name

### Values

*filename*

Data type: character vector

Default: temp

### Description

This property specifies the file name for the video recording.

## VideoQuality property

**Class:** Aero.Animation

**Package:** Aero

Video recording quality

### Values

Value between 0 and 100

Data type: double

Default: 75

### Description

This property specifies the recording quality. For more information on video quality, see the [Quality](#) property in `VideoWriter`.

## VideoRecord property

**Class:** Aero.Animation

**Package:** Aero

Video recording

### Values

**'on'**

Enable video recording.

**'off'**

Disable video recording.

**'scheduled'**

Schedule video recording. Use this setting with the `VideoTStart` and `VideoTFinal` properties.

Data type: character vector

Default: 'off'

### Description

This property enables video recording of animation objects.

If you are capturing frames of a plot that takes a long time to generate or are repeatedly capturing frames in a loop, make sure that your computer's screen saver does not activate and that your monitor does not turn off for the duration of the capture; otherwise one or more of the captured frames can contain graphics from your screen saver or nothing at all.

---

**Note:** In situations where MATLAB software is running on a virtual desktop that is not currently visible on your monitor, it may capture a region on your monitor that

corresponds to the position occupied by the figure or axes on the hidden desktop. Therefore, make sure that the window to be captured exists on the currently active desktop.

---

## Examples

### Record Animation Object Simulation

Simulate and record flight data. Create an animation object.

```
h = Aero.Animation;
```

Control the frame display rate.

```
h.FramesPerSecond = 10;
```

Set the time-scaling (`TimeScaling`) property on the animation object to specify the data per second.

```
h.TimeScaling = 5;
```

The combination of `FramesPerSecond` and `TimeScaling` properties determines the time step of the simulation. These settings result in a time step of approximately 0.5 s.

Create and load a body for the animation object.

```
idx1 = h.createBody('pa24-250_orange.ac', 'Ac3d');
```

Load simulated flight trajectory data (`simdata`), located in `matlabroot\toolbox\ aero \astdemos`.

```
load simdata;
```

Set the time series data for the body.

```
h.Bodies{1}.TimeSeriesSource = simdata;
```

Create a figure object for the animation object.

```
h.show();
```



Set up recording properties.

```
h.VideoRecord = 'on';  
h.VideoQuality = 50;  
h.VideoCompression = 'Motion JPEG AVI'  
h.VideoFilename = 'astMotion_JPEG';
```

h =

Aero.Animation

Play the animation.



```
h.play();
```

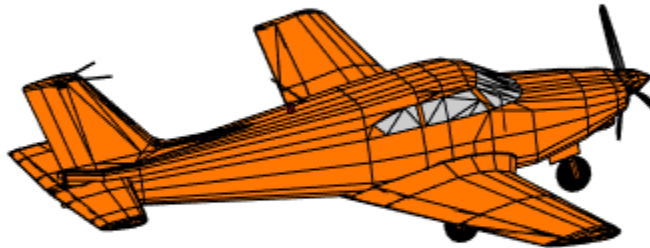

Verify that a file named `astMotion_JPEG.avi` was created in the current folder.

Disable recording to preserve the file.

```
h.VideoRecord = 'off';
```

### **Record Animation for Four Seconds**

Simulate flight data for four seconds. Create an animation object.

```
h = Aero.Animation;
```

Control the frame display rate.

```
h.FramesPerSecond = 10;
```

Configure the animation object to set the seconds of animation data per second time-scaling (`TimeScaling`) property.

```
h.TimeScaling = 5;
```

The combination of `FramesPerSecond` and `TimeScaling` properties determines the time step of the simulation (`TimeScaling/|FramesPerSecond|`). These settings result in a time step of approximately 0.5 s.

Create and load a body for the animation object.

```
idx1 = h.createBody('pa24-250_orange.ac', 'Ac3d');
```

Load simulated flight trajectory data (`simdata`), located in `matlabroot\toolbox\ aero \astdemos`.

```
load simdata;
```

Set the time series data for the body.

```
h.Bodies{1}.TimeSeriesSource = simdata;
```

Create a figure object for the animation object.

```
h.show();
```



Set up recording properties.

```
h.VideoRecord='on';  
h.VideoQuality = 50;  
h.VideoCompression = 'Motion JPEG AVI';  
h.VideoFilename = 'astMotion_JPEG';
```

Play the animation from TFinal to TStart.

```
h.TStart = 1;  
h.TFinal = 5;  
h.play();
```

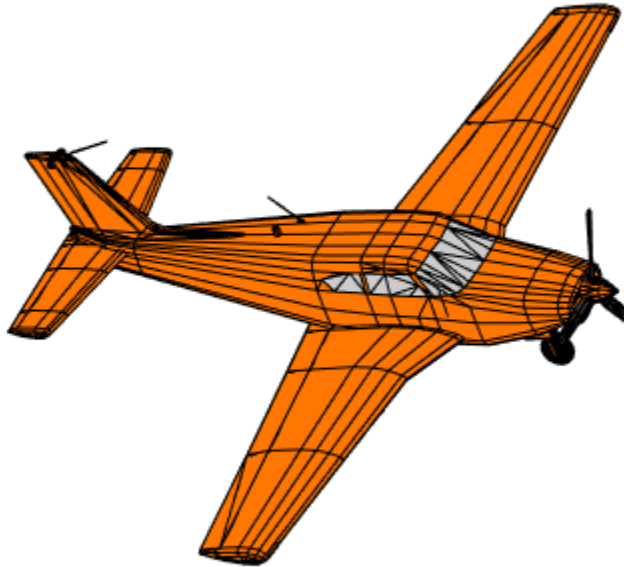

Verify that a file named `astMotion_JPEG.avi` was created in the current folder. When you rerun the recording, notice that the play time is shorter than that in the previous example when you record for the length of the simulation time.

Disable recording to preserve the file.

```
h.VideoRecord = 'off';
```

### **Schedule Three Second Recording of Simulation**

Schedule three second recording of animation object simulation. Create an animation object.

```
h = Aero.Animation;
```

Control the frame display rate.

```
h.FramesPerSecond = 10;
```

Configure the animation object to set the seconds of animation data per second time-scaling (`TimeScaling`) property.

```
h.TimeScaling = 5;
```

The combination of `FramesPerSecond` and `TimeScaling` properties determines the time step of the simulation (`TimeScaling/|FramesPerSecond|`). These settings result in a time step of approximately 0.5 s.

Create and load a body for the animation object.

```
idx1 = h.createBody('pa24-250_orange.ac', 'Ac3d');
```

Load simulated flight trajectory data (`simdata`), located in `matlabroot\toolbox\ aero \astdemos`.

```
load simdata;
```

Set the time series data for the body.

```
h.Bodies{1}.TimeSeriesSource = simdata;
```

Create a figure object for the animation object.

```
h.show();
```



Set up recording properties.

```
h.VideoQuality = 50;  
h.VideoCompression = 'Motion JPEG AVI';  
h.VideoFilename = 'astMotion_JPEG';
```

Set up simulation time from TFinal to TStart.

```
h.TStart = 1;  
h.TFinal = 5;
```

Set up to record between two and four seconds of the four second simulation.

```
h.VideoRecord='scheduled';
```

```
h.VideoTStart = 2;  
h.VideoTFinal = 4;
```

Play the animation.

```
h.play();
```

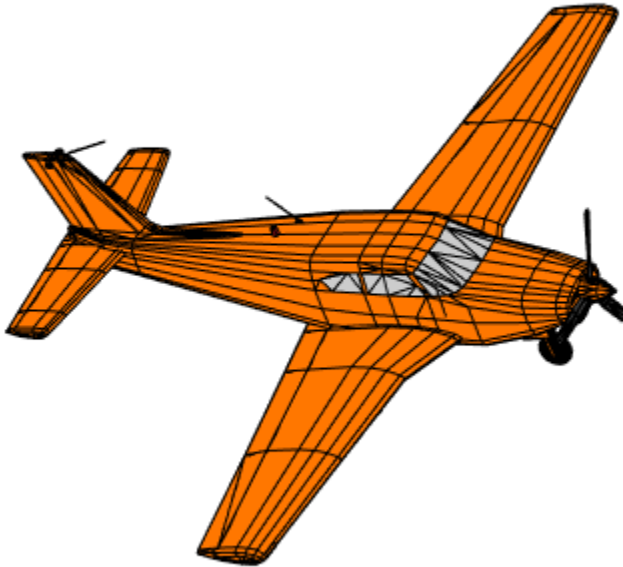

Verify that a file named `astMotion_JPEG.avi` was created in the current folder. When you rerun the recording, notice that the play time is shorter than that in the previous example when you record for the length of the simulation time.

Disable recording to preserve the file.

```
h.VideoRecord = 'off';
```

## VideoTFinal property

**Class:** Aero.Animation

**Package:** Aero

Video recording stop time for scheduled recording

### Values

Value between TStart and TFinal

Data type: double

Default: NaN, which uses the value of TFinal

### Description

This property specifies the stop time of scheduled recording.

Use when VideoRecord is set to 'scheduled'. Use VideoTStart to set the start time of the recording.



# VideoTStart property

**Class:** Aero.Animation

**Package:** Aero

Video recording start time for scheduled recording

## Values

Value between `TStart` and `TFinal`

Data type: double

Default: NaN, which uses the value of `TStart`.

## Description

This property specifies the start time of the scheduled recording.

Use when `VideoRecord` is set to 'scheduled'. Use `VideoTFinal` to set the end time of the recording.









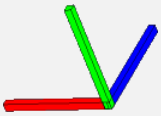
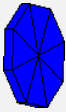

# AC3D Files and Thumbnails

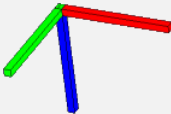
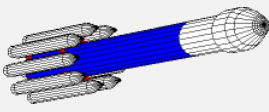
---

## AC3D Files and Thumbnails Overview

Aerospace Toolbox demos use the following AC3D files, located in the *matlabroot\toolbox\ aero\astdemos* folder. For other AC3D files, see <http://www.flightgear.org/Downloads/> and click the **Download Aircraft** link.

Thumbnail	AC3D File
	ac3d_xyzisrgb.ac
	blueoctagon.ac
	bluwedge.ac
	body_xyzisrgb.ac
	delta2.ac
	greenarrow.ac
	pa24-250_blue.ac
	pa24-250_orange.ac
	redwedge.ac

Thumbnail	AC3D File
	testrocket.ac

